



EEAC331B POLARTEK PLUS®

R134a Refrigerant Recovery/ Recycle / Recharge
Service Vehicle A/C System



PARTS MANUAL

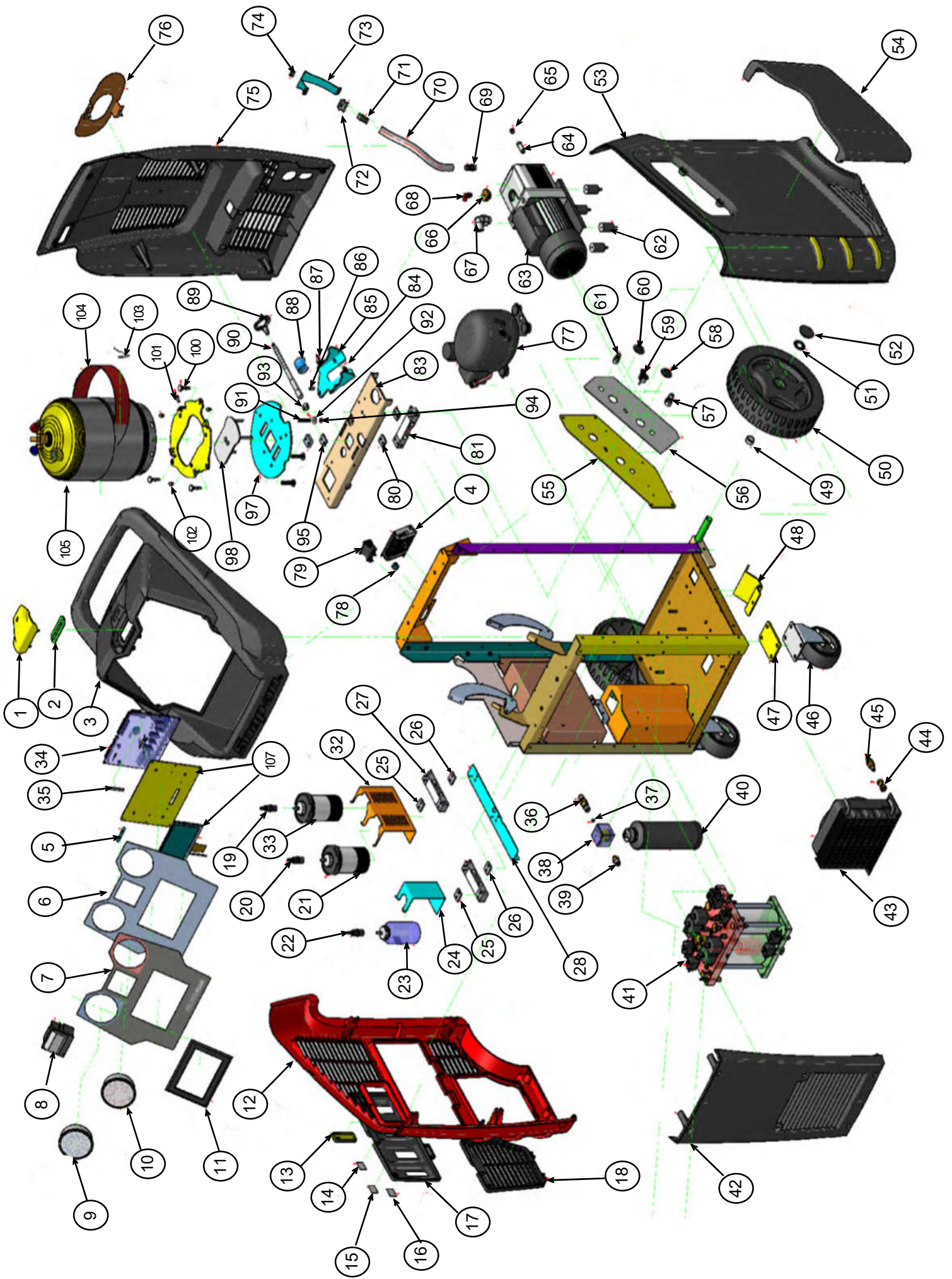

REF#	PART NUMBER	DESCRIPTION
1	EEAC331-12	TRANSPARENT LED COVER
2	EEAC331-18	LED LIGHT MOTHERBOARD
3	EEAC330-43	UPPER PLASTIC CARTER
4	EEAC330B-12	POWER SUPPLY
5	EEAC330-119	CONTROL PANEL FIXING PLATE
6	EEAC331B-2	CONTROL PANEL (7" DISPLAY)
7	EEAC331-5	POLARTEK PLUS CONT. PNL STICKER
8	GRSTM0007D	PRINTER
9	EEAC331-10	LP 100MM GAUGE
10	EEAC331-9	HP 100MM GAUGE
11	EAC331B-7	7" DISPLAY FRAME
12	EEAC330-36	RIGHT PLASTIC COVER
13	EEAC330-41	OIL DOOR CAP
14	EEAC330-2	NEW OIL GLAZED STICKER
15	EEAC331-2	UV GLAZED STICKER
16	EEAC330-3	USED OIL GLAZED STICKER
17	EEAC330-39	OIL DOOR
18	EEAC330-40	FILTER DOOR
19	EEAC330-58	NEW OIL CONTAINER PLUG - BLUE BUTTON
20	EEAC331-16	UV CONTAINER PLUG - YELLOW BUTTON
21	EEAC331-6	UV CONTAINER - YELLOW CAP
22	EEAC330-57	USED OIL CONTAINER PLUG - RED BUTTON
23	EEAC330-27	USED OIL CONTAINER - RED CAP
24	CRP4164-V	USED OIL CONTAINER SUPPORT
25	EEAC330-12	SCALE SPACER 4MM
26	EEAC330-12	SCALE SPACER 4MM
27	EEAC330-10	USED OIL SCALE - 15KG
28	CRP5036	OIL SUPPORT BRACKET
29	EEAC330-12	SCALE SPACER 4MM
30	EEAC330-10	NEW OIL/UV SCALE - 15KG
31	EEAC330-12	SCALE SPACER 4MM
32	CRP4076	NEW OIL/UV CONTAINERS SUPPORT
33	EEAC331-7	NEW OIL CONTAINER - BLUE CAP
34	EEAC331B-9	MOTHERBOARD
35	EEAC330B-11	WIFI ANTENNA

REF#	PART NUMBER	DESCRIPTION
36	EEAC330-83	3/8 SAE CHECK VALVE
37	EEAC334-41	1/8GAS FILTER FITTING
38	EEAC330-96	FILTER MANIFOLD
39	EEAC330-97	NIPPLE 1/8GAS-3/8SAE
40	EEAC330-23B	DRYER FILTER
41	EEAC331B-3	MANIFOLD
42	EEAC330-42	FRONT PLASTIC COVER
43	EEAC330B-6	CONDENSER WITH FAN
44	EEAC330-54	DOUBLE PIPE UNION
45	EEAC330-82	1/4SAE CHECK VALVE
46	EEAC330-59	FRONT CASTER WITH BRAKE
47	CRP5024	FRONT CASTER SPACER
48	CRP4198	FOOT BRACKET
49	RAC6020	REAR WHEEL SPACER
50	EEAC330-60	300MM REAR WHEEL
51	EEAC330-61	REAR WHEEL RETAINER
52	EEAC330-67	REAR WHEEL CAP
53	EEAC330-35	LEFT PLASTIC COVER
54	EEAC330-38	PLASTIC POCKET
55	CRP5019	SIDE CONNECTION PLATE
56	EEAC331-4	SIDE CONNECTION STICKER
57	EEAC331-15	ALUMINUM HP QUICK FITTING
58	EEAC330-68	PROTECTION HP HOSE OUTLET
59	EEAC330-21	USB PORT
60	EEAC330-68	PROTECTION LP HOSE OUTLET
61	EEAC331-14	ALUMINUM L+G11:I49P QUICK FITTING
62	EEAC330-49	ANTI VABRATION RUBBER
63	EEAC331-13	VACUUM PUMP
64	EEAC330-116	OIL DRAIN EXTENSION
65	EEAC334-49	OIL DRAIN CAP
66	EEAC330-117	FITTING M24 - 1/8GAS
67	EEAC334-92	10MM ELBOW OGIVE FITTING
68	EEAC334-48	6MM ELBOW OGIVE FITTING
69	EEAC334-43	HOSE FITTING 16MM
70	EEAC334-44	OIL PUMP FILLING HOSE

REF#	PART NUMBER	DESCRIPTION
71	EEAC334-45	HOSE FITTING 16MM
72	EEAC334-47	MOUNT ADAPTER FITTING
73	EEAC330-118	OIL PUMP FILLING BRACKET
74	EEAC334-46	OIL PUMP FILLING CAP
75	EEAC330-37	REAR PLASTIC COVER
76	EEAC330-14	CORD WRAP
77	EEAC330B-5	COMPRESSOR
78	EEAC330-18	CABLE GUIDE FOR POWER CABLE
79	EEAC330-19	MAIN SWITCH (CIRCUIT BREAKER)
80	EEAC330-12	SCALE SPACER 4MM
81	EEAC330-124	TANK SCALE - 50KG
82	EEAC330-12	SCALE SPACER 4MM
83	CRP5048	MIDDLE LEVEL FRAME REINFORCEMENT
84	EEAC334-56	COMPRESSION SPRING
85	CRP5052	TANK LOCK LEVER
86	EEAC330A-6	THREADED BALL SPRING PLUNGER
87	RAC5209	CAM PLATE
88	RAC5208	CAM
89	EEAC330A-3	TANK LOCK/UNLOCK HANDLE
90	RAC5206	LOCK LEVER SHAFT
91	EEAC334-56	COMPRESSION SPRING
92	VIT0004	WASHER FOR COMPRESSION SPRING
93	VIT0070	M12 NUT
94	VIT0023	M6 NUT
95	EEAC330-12	SCALE SPACER 4MM
96	EEAC330-100	SCALE SPACER 10MM
97	CRP5049	TANK PLATE1
98	CRP5051	DAMPER PLATE
99	CRP5050	TANK PLATE2
100	EEAC330A-5	TANK PLATE STOP SCREW
101	VIT0069	TANK FIXING BOLT
102	EEAC330A-4	TANK PLATE CENTERING PIN
103	EEAC330-66	TANK TEMPERATURE PROBE
104	EEAC330B-2	TANK HEATER
105	EEAC330-11	REFRIGERANT STORAGE TANK
107	EEAC331B-13 OR EEAC331B-14	7" LCD DISPLAY W/ METAL SUPPORT

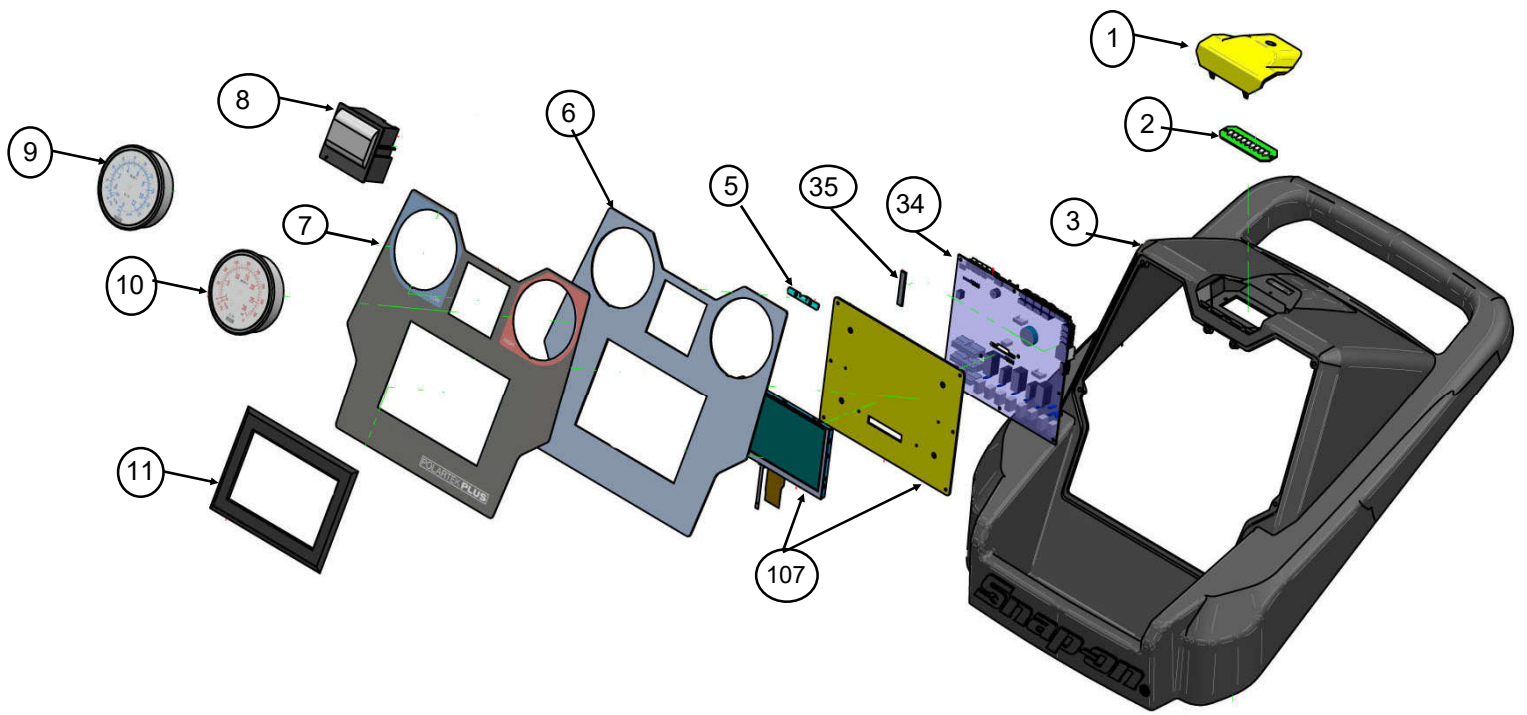

REF#	PART NUMBER	DESCRIPTION
1	EEAC331-12	TRANSPARENT LED COVER
2	EEAC331-18	LED LIGHT MOTHERBOARD
3	EEAC330-43	UPPER PLASTIC CARTER
5	EEAC330-119	CONTROL PANEL FIXING PLATE
6	EEAC331B-2	CONTROL PANEL (7" DISPLAY)
7	EEAC331-5	POLARTEK PLUS CONT PNL STICKER
8	GRSTM0007D	PRINTER
9	EEAC331-10	LP 100MM GAUGE
10	EEAC331-9	HP 100MM GAUGE
11	EAC331B-7	7" DISPLAY FRAME
34	EEAC331B-9	MOTHERBOARD
35	EEAC330B-11	WIFI ANTENNA
107	EEAC331B-13 OR EEAC331B-14	7" LCD DISPLAY W/ METAL SUPPORT

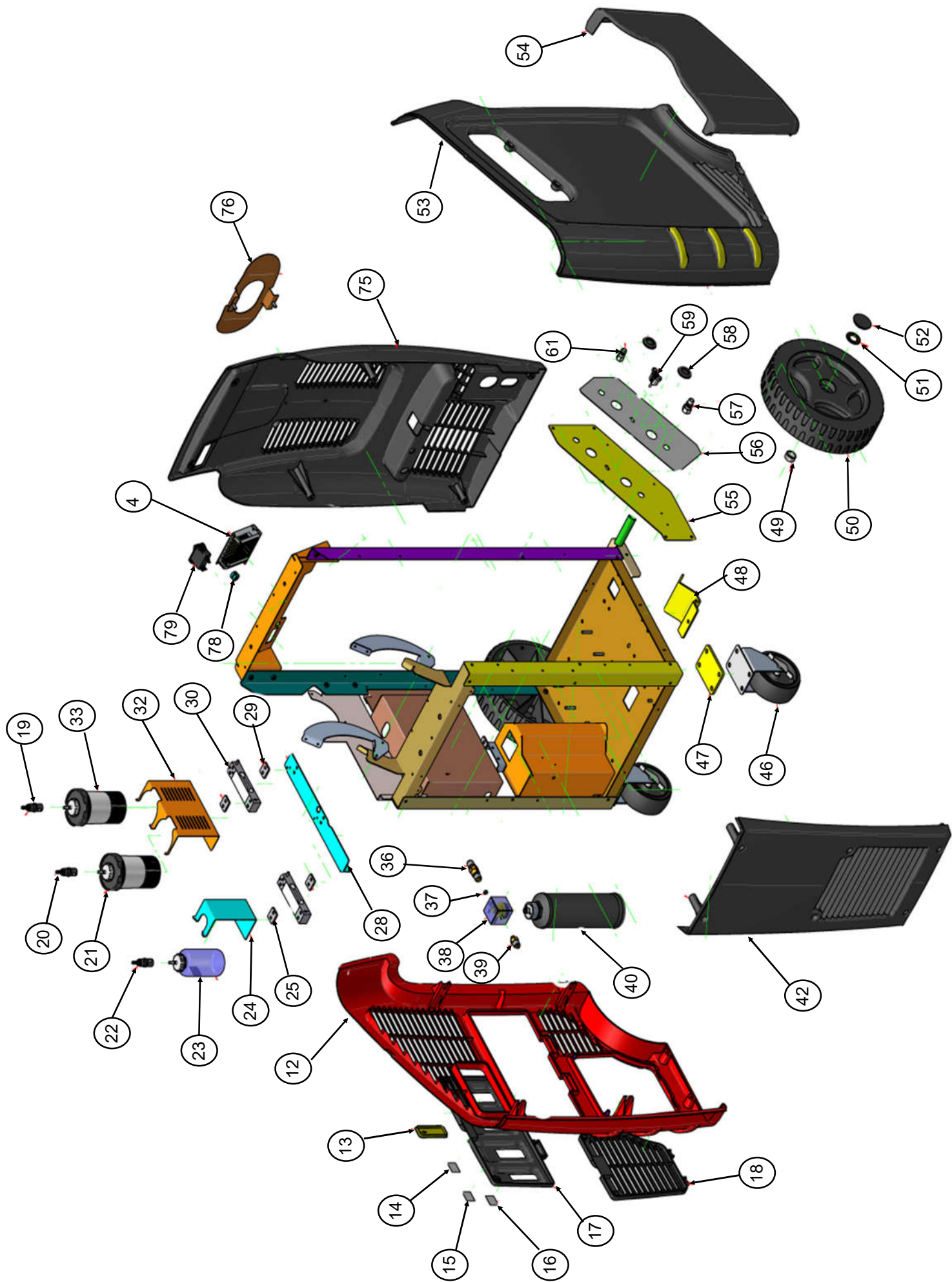

REF#	PART NUMBER	DESCRIPTION
4	EEAC330B-12	POWER SUPPLY
12	EEAC330-36	RIGHT PLASTIC COVER
13	EEAC330-41	OIL DOOR CAP
14	EEAC330-2	NEW OIL GLAZED STICKER
15	EEAC331-2	UV GLAZED STICKER
16	EEAC330-3	USED OIL GLAZED STICKER
17	EEAC330-39	OIL DOOR
18	EEAC330-40	FILTER DOOR
19	EEAC330-58	NEW OIL CONTAINER PLUG - BLUE BUTTON
20	EEAC331-16	UV CONTAINER PLUG - YELLOW BUTTON
21	EEAC331-6	UV CONTAINER - YELLOW CAP
22	EEAC330-57	USED OIL CONTAINER PLUG - RED BUTTON
23	EEAC330-27	USED OIL CONTAINER - RED CAP
24	CRP4164-V	USED OIL CONTAINER SUPPORT
25	EEAC330-12	SCALE SPACER 4MM
26	EEAC330-12	SCALE SPACER 4MM
27	EEAC330-10	USED OIL SCALE - 15KG
28	CRP5036	OIL SUPPORT BRACKET
49	EEAC334-42	1/8GAS FILTER FITTING
50	EEAC330-60	300MM REAR WHEEL
51	EEAC330-61	REAR WHEEL RETAINER
52	EEAC330-67	REAR WHEEL CAP
53	EEAC330-35	LEFT PLASTIC COVER
54	EEAC330-38	PLASTIC POCKET
55	CRP5019	SIDE CONNECTION PLATE
56	EEAC331-4	SIDE CONNECTION STICKER
29	EEAC330-12	SCALE SPACER 4MM
30	EEAC330-10	NEW OIL/UV SCALE - 15KG
31	EEAC330-12	SCALE SPACER 4MM
32	CRP4076	NEW OIL/UV CONTAINERS SUPPORT

REF#	PART NUMBER	DESCRIPTION
33	EEAC331-7	NEW OIL CONTAINER - BLUE CAP
36	EEAC330-83	3/8SAE CHECK VALVE
37	EEAC334-41	1/8GAS FILTER FITTING
38	EEAC330-96	FILTER MANIFOLD
39	EEAC330-97	NIPPLE 1/8GAS-3/8SAE
40	EEAC330-23B	DRYER FILTER
41	EEAC331B-3	MANIFOLD
42	EEAC330-42	FRONT PLASTIC COVER
43	EEAC330B-6	CONDENSER WITH FAN
44	EEAC330-54	DOUBLE PIPE UNION
45	EEAC330-82	1/4SAE CHECK VALVE
46	EEAC330-59	FRONT CASTER WITH BRAKE
47	CRP5024	FRONT CASTER SPACER
48	EEAC330-84	3/8 SAE CHECK VALVE
57	EEAC331-15	ALUMINUM HP QUICK FITTING
58	EEAC330-68	PROTECTION HP HOSE OUTLET
59	EEAC330-21	USB PORT
60	EEAC330-68	PROTECTION LP HOSE OUTLET
61	EEAC331-14	ALUMINUM L+G11:I49P QUICK FITTING
75	EEAC330-37	REAR PLASTIC COVER
76	EEAC330-14	CORD WRAP
78	EEAC330-18	CABLE GUIDE FOR POWER CABLE
79	EEAC330-19	MAIN SWITCH (CIRCUIT BREAKER)

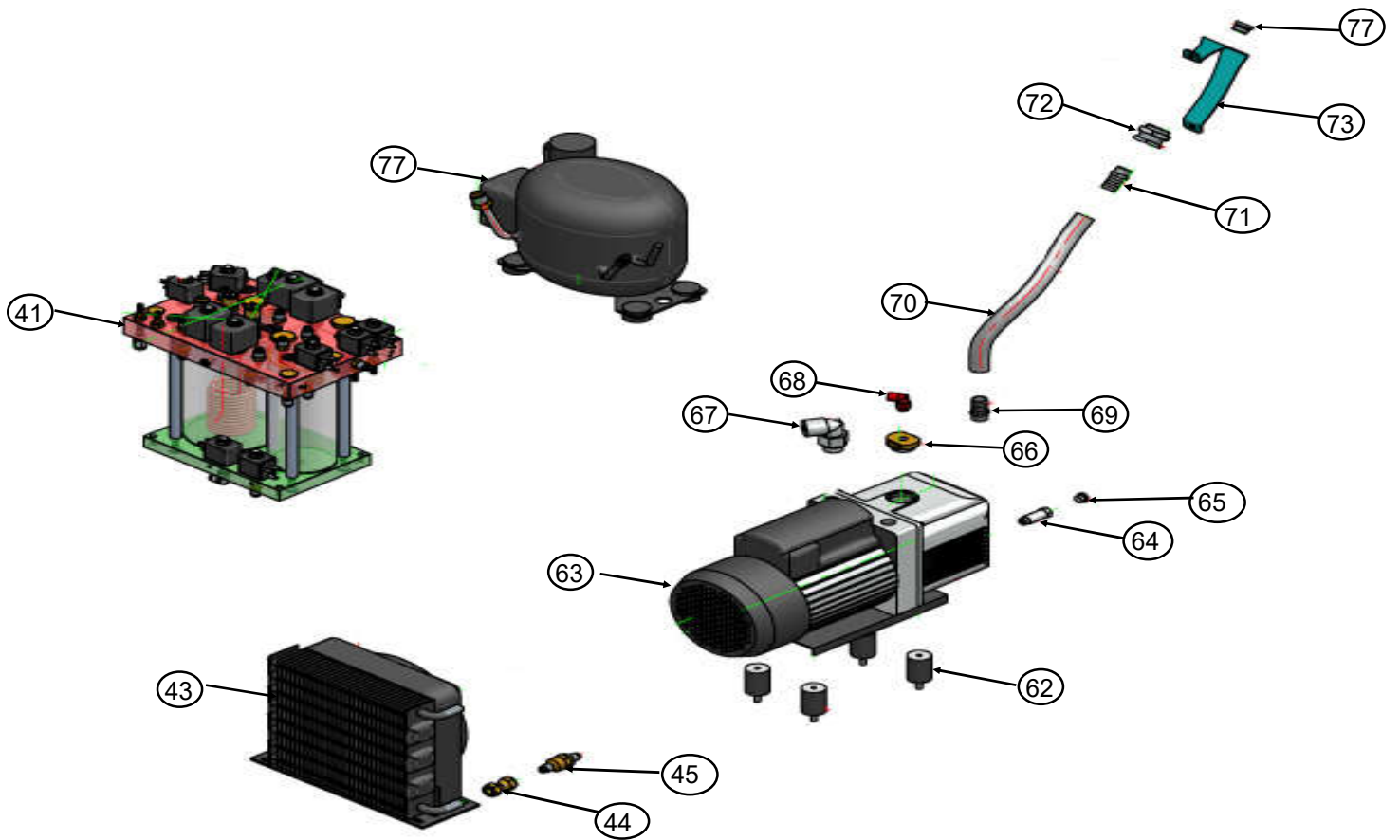

REF#	PART NUMBER	DESCRIPTION
41	EEAC331B-3	MANIFOLD
42	EEAC330-42	FRONT PLASTIC COVER
43	EEAC330B-6	CONDENSER WITH FAN
44	EEAC330-54	DOUBLE PIPE UNION
45	EEAC330-82	1/4SAE CHECK VALVE
62	EEAC330-49	ANTIVABRION RUBBER
63	EEAC331-13	VACUUM PUMP
64	EEAC330-116	OIL DRAIN EXTENSION
65	EEAC334-49	OIL DRAIN CAP
66	EEAC330-117	FITTING M24 - 1/8GAS
67	EEAC334-92	10MM ELBOW OGIVE FITTING
68	EEAC334-48	6MM ELBOW OGIVE FITTING
69	EEAC334-43	HOSE FITTING 16MM
70	EEAC334-44	OIL PUMP FILLING HOSE
71	EEAC334-45	HOSE FITTING 16MM
72	EEAC334-47	MOUNT ADAPTER FITTING
73	EEAC330-118	OIL PUMP FILLING BRACKET
74	EEAC334-46	OIL PUMP FILLING CAP

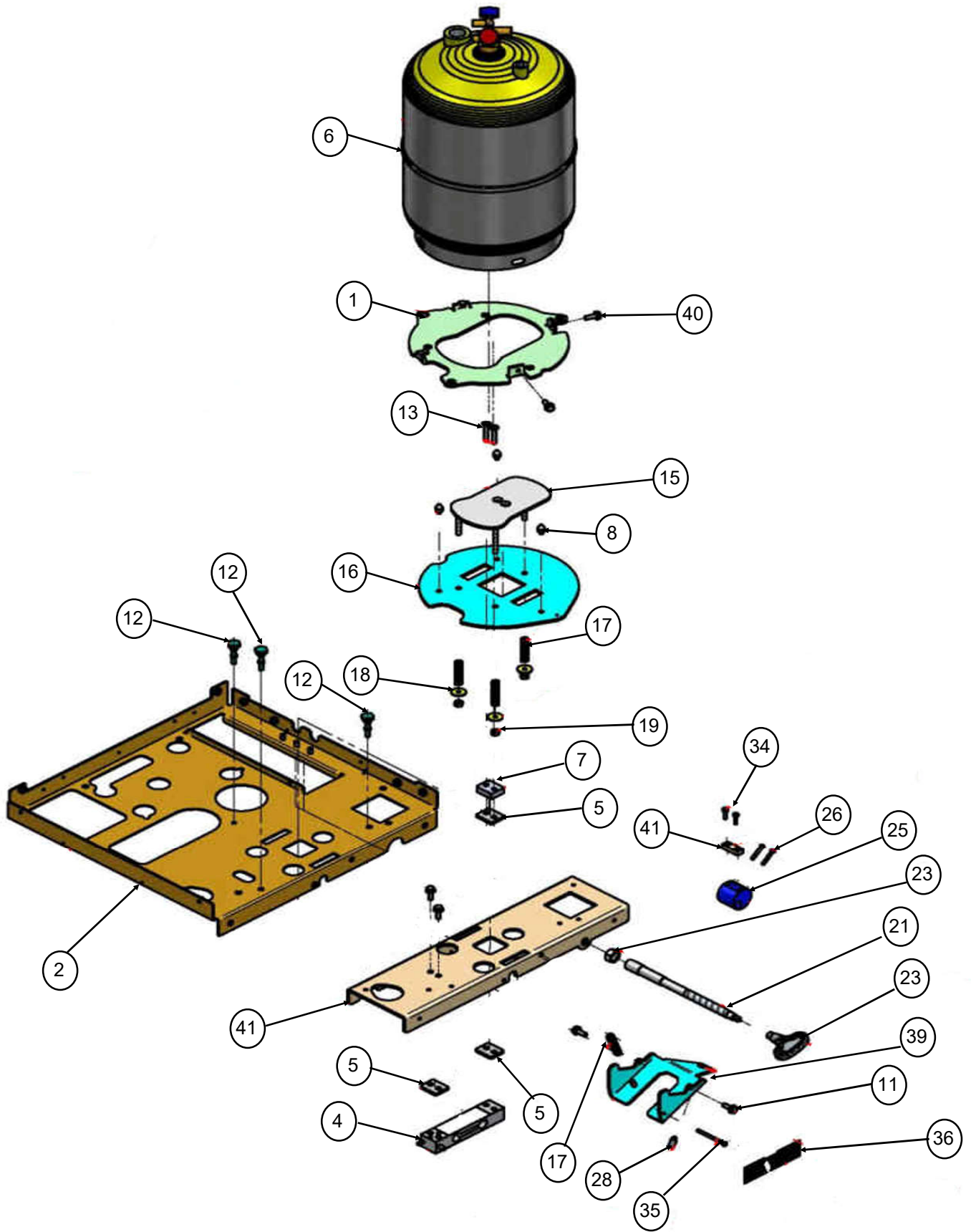



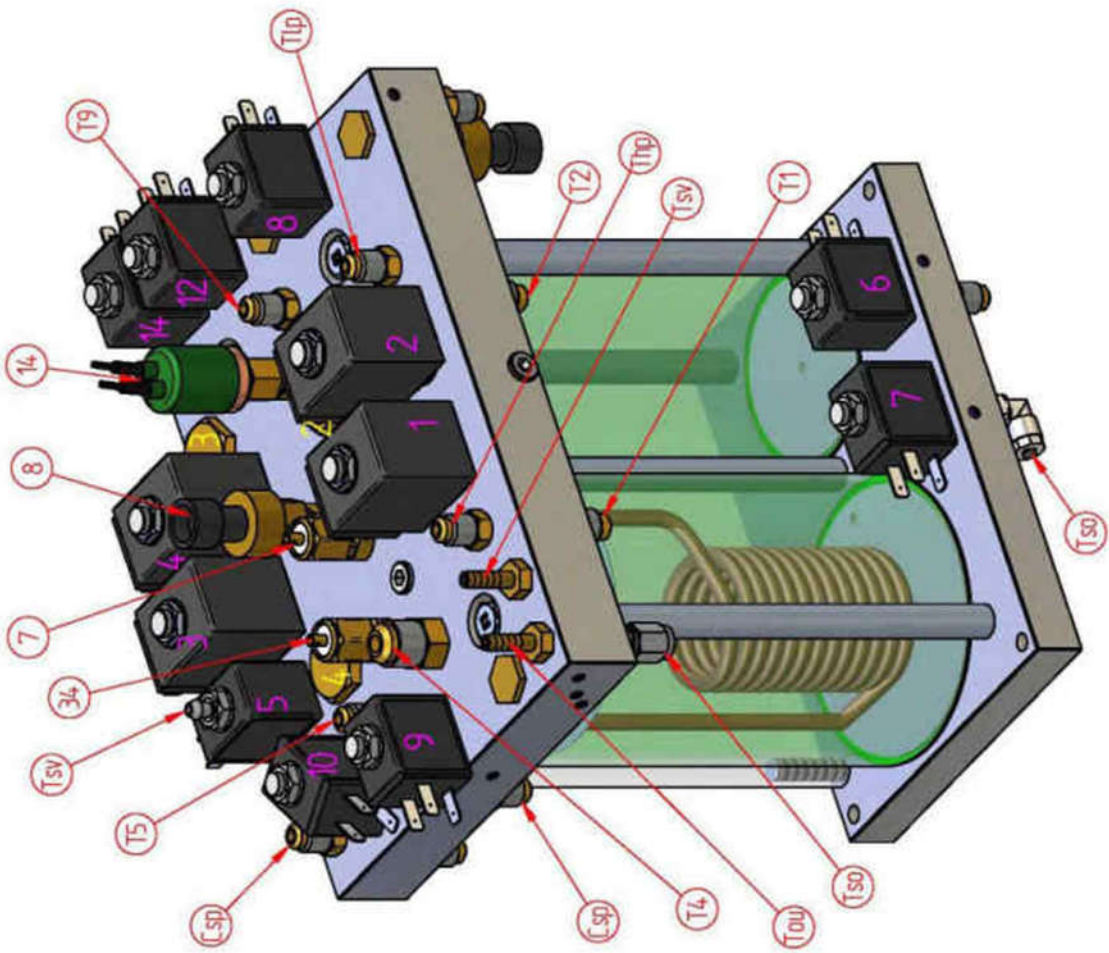
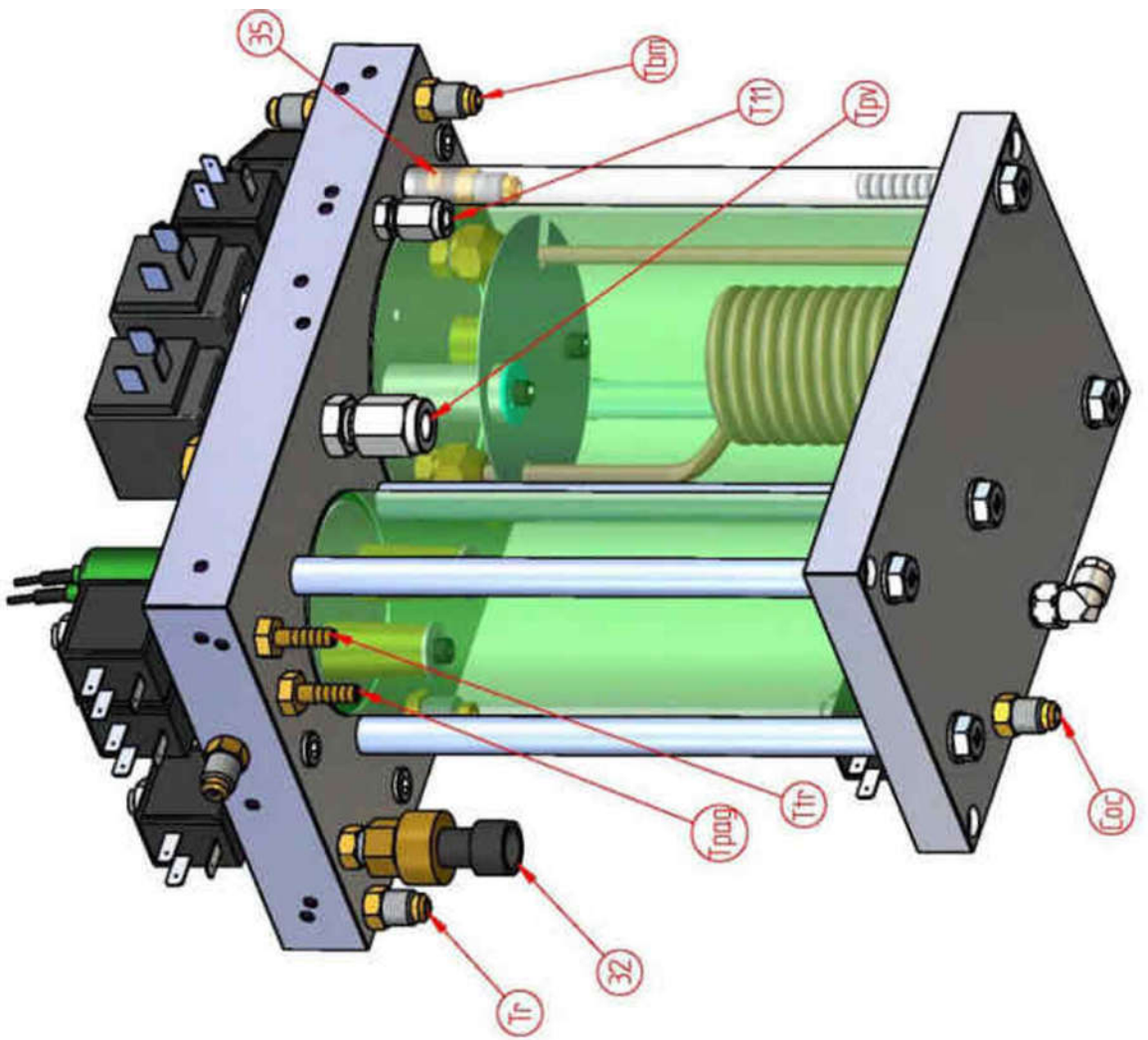













REF#	PART NUMBER	DESCRIPTION
1	CRP5050	TANK PLATE2
2	CRP5047	MIDDLE LEVEL FRAME
3	CRP5048	MIDDLE LEVEL FRAME REINFORCEMENT
4	EEAC330-124	TANK SCALE - 50KG
5	EEAC330-12	SCALE SPACER 4MM
6	EEAC330-11	REFRIGERANT STORAGE TANK
7	EEAC330-100	SCALE SPACER 10MM
8	EEAC330A-4	TANK PLATE CENTERING PIN
11	VIT0069	M6 SCREW
12	EEAC330A-5	TANK PLATE STOP SCREW
13	VIT0024	M6 SCREW
15	CRP5051	DUMPER PLATE
16	CRP5049	TANK PLATE1
17	RAC0522	COMPRESSION SPRING
18	VIT0004	WASHER FOR COMPRESSION SPRING
19	VIT0023	M6 NUT
20	CRP5052	TANK LOCK LEVER
21	RAC5206	LOCK LEVER SHAFT
23	VIT0070	M12 NUT
24	EEAC330A-3	TANK LOCK/UNLOCK HANDLE
25	RAC5208	CAM
26	VIT0064	M4 SCREW
27	RAC5209	CAM PLATE
28	EEAC330A-6	THREADED BALL SPRING PLUNGER
34	VIT0065	M4 SCREW
35	VIT0063	LOCKED/UNLOCKED SCREW
36	EEAC330A-1	LOCKED/UNLOCKED STICKER
39	RACXXXX	THREADED BALL SPRING FITTING
40	VIT0069	TANK FIXING BOLT
N/S	EEAC330B-2	TANK HEATER
N/S	EEAC330-66	TEMP PROBE

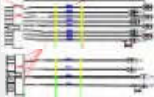

REF#	PART NUMBER	DESCRIPTION
1	ELT1171	EV1 HIGH PRESSURE SOLENIOD VALVE
1A	VLV1170	EV1 HIGH PRESSURE SPOOL VALVE
2	ELT1171	EV2 LOW PRESSURE SOLENIOD VALVE
2A	VLV1170	EV2 LOW PRESSURE SPOOL VALVE
3	ELT1171	EV3 OUTLET EVAPORATOR SOLENIOD VALVE
3A	VLV1170	EV3 OUTLET EVAPORATOR SPOOL VALVE
4	ELT1171	EV4 INLET VACUUM SOLENIOD VALVE
4A	VLV1170	EV4 INLET VACUUM SPOOL VALVE
5	ELT1175	EV5 OUTLET VACUUM SOLENIOD VALVE
5A	VLV1177	EV5 OUTLET VACUUM SPOOL VALVE
6	ELT1175	EV6 OIL COMPR. REFILL SOLENIOD VALVE
6A	VLV1175	EV6 OIL COMPR. REFILL SPOOL VALVE
7	ELT1175	EV7 OIL DISCHARGE SOLENIOD VALVE
7A	VLV1175	EV7 OIL DISCHARGE SPOOL VALVE
8	ELT1175	EV8 REFILLING SOLENIOD VALVE
8A	VLV1175	EV8 REFILLING SPOOL VALVE
TSV	EEAC330-75	VACUUM PUMP DISCHARGE
TOU	EEAC330-75	MANIFOLD-USED OIL CONTAINER
TLP	EEAC330-89	MANIFOLD-LP MANOMETER
THP	EEAC330-89	MANIFOLD-HP MANOMETER
Coc	EEAC330-89	EV6-COMPRESSOR
34	EEAC330-85	VACUUM PUMP SAFETY VALVE (1 BAR)
TSO	EEAC330-77	OIL DISCHARGE BYPASS
CSP	EEAC330-90	AIR PURGE BYPASS
9	ELT1175	EV9 EVAP. OVER PRESSURE SOLENIOD VALVE
9A	VLV1175	EV9 EVAP. OVER PRESSURE SPOOL VALVE













REF#	PART NUMBER	DESCRIPTION
10	ELT1175	EV10 AIR PURGE SOLENIOD VALVE
10A	VLV1175	EV10 AIR PURGE SPOOL VALVE
12	ELT1175	EV12 NEW PAG OIL SOLENIOD VALVE
12A	VLV1175	EV12 NEW PAG OIL SPOOL VALVE
14	ELT1175	EV14 DYE TRACER SOLENIOD VALVE
14A	VLV1175	EV14 DYE TRACER SPOOL VALVE
T1	EEAC331-21	HIGH PRESSURE FITTING-EV1
T2	EEAC331-22	LOW PRESSURE FITTING-EV2
T4	TUBX085	EVAPORATOR-FILTER
T5	TUBX086	MANIFOLD HEATER-CONDENSER
T9	EEAC330-127	COMPRESSOR-OIL SEPARATOR
7	EEAC330-84	SAFETY VALVE (12BAR)
8	EEAC330-69	A/C PRESSURE TRANSDUCER
14	EEAC330-48	SAFETY PRESSURE SWITCH (20 BAR)
Tbm	EEAC330-89	TANK 3RD CONNECTION - EV9
Tpv	EEAC330-78	EV4-VACUUM PUMP
T11	EEAC330-77	PUMP-EV5
32	EEAC330-69	BOTTLE PRESSURE TRANSDUCER
35	RAC5885	AIR PURGE FILTER
Ttr	EEAC330-75	MANIFOLD-TRACER CONTAINER
Tpag	EEAC330-75	MANIFOLD-NEW PAG OIL CONTAINER
Tr	EEAC330-74	REFRIGERANT BOTTLE (HP SIDE)-MANIFOLD















PART NUMBER	IMAGE	DESCRIPTION
EEAC330-1		PRINTER STICKER
EEAC330-1		GROUND STICKER
EEAC330-3		USED OIL STICKER
EEAC333-1		R1234yF BOTTLE STICKER
EEAC331-4		SIDE CONNECTION STICKER
EEAC332-1		CONTROL PANEL
EEAC333-3		HIGHSIDE QUICK COUPLER
EEAC333-4		LOWSIDE QUICK COUPLER
EEAC330-8		LOWSIDE ADAPTER R134
EEAC330-124		LOAD CELL 50Kg
EEAC330-10		LOAD CELL 15Kg
EEAC330-11		30lb STORAGE BOTTLE
EEAC330-12		SPACER SCALE PLATE
EEAC330-13		FILTER WRENCH
EEAC330-14		CORD WRAP
EEAC330-17		POWER CORD











PART NUMBER	IMAGE	DESCRIPTION
EEAC331B-1		7" DISPLAY SHEET METAL
EEAC331B-2		CONTROL PANEL SHEET METAL
EEAC320B-1		MANIFOLD POLARTEK B
EEAC330B-2		TANK HEATER
EEAC331B-4		PRINTER CABLE
EEAC330B-4		POWER SUPPLY CABLE
EEAC330B-5		R134a COMPRESSOR
EEAC330-6		CONDENSER W/FAN
GRELT050		SOLENOID WIRING HARNESS
EEAC331B-7		7" DISPLAY FRAME
EEAC330B-11		WIFI ANTENNA
EEAC330B-12		POWER SUPPLY
EEAC331B-8		FLAT CABLE DISPLAY ADAPTER
EEAC331B-9		NEVOPLUS MOTHER BOARD
EEAC331B-13 or EEAC331B-14		7" DISPLAY
EEAC331B-11		50PIN FLAT CABLE (EEAC331B-8)
EEAC331B12		4 PIN FLAT CABLE (EEAC331B-8)

PART NUMBER	IMAGE	DESCRIPTION
EEAC330-18		CABLE GUIDE
EEAC330-19		POWER SWITCH W/BREAKER
EEAC330-21		USB CABLE
EEAC330-22		PRESSURE TRANS. HARNESS
EEAC330-23B		FILTER DYER
EEAC330-27		USED OIL BOTTLE
EEAC330-28		F1/4 CAP W/GASKET
EEAC330-29		FOAM POCKET
EEAC330CVR		SINGLE GAS COVER
EEAC330-30		HIGHSIDE PRESSURE GAUGE
EEAC330-31		LOWSIDE PRESSURE GAUGE
EEAC330-35		LEFT SIDE PLASTIC COVER
EEAC330-36		RIGHT SIDE PLASTIC COVER
EEAC330-37		REAR PLASTIC COVER
EEAC330-38		SIDE POCKET
EEAC330-39		OIL DOOR









PART NUMBER	IMAGE	DESCRIPTION
EEAC330-40		FILTER DOOR
EEAC330-41		OIL DOOR CAP
EEAC330-42		FRONT PLASTIC COVER
EEAC330-43		UPPER PLASTIC COVER
EEAC331-11		7" DISPLAY FRAME
EEAC331-12		LED COVER
EEAC331-18		LED BOARD
GRSTM0007D		PRINTER
EEAC331-20		THERMAL PRINTER PAPER
ELT1045-C		ELECTRONIC VALVE
ELT1165		ELECTRONIC VALVE
VLV1450-N		SPOOL VALVE
VLV7000		3 WAY SPOOL VALVE
VLV1160-N		SPOOL VALVE
EEAC330-80		CHECK VALVE
EEAC330-55		1/8 M/F BALL VALVE

PART NUMBER	IMAGE	DESCRIPTION
ACT71-0A		VACUUM PUMP OIL
EEAC330-47		VACUUM PUMP
EEAC330-49		RUBBER ISOLATORS
EEAC330-48		20 BAR SAFETY SWITCH
EEAC330-69		PRESSURE TRANSDUCER
EEAC330-54		1/4 DOUBLE UNION
EEAC330-56		CAL. REF. WEIGHT
EEAC330-57		RED OIL DRAIN FITTING
EEAC330-59		FRONT CASTER W/LOCK
EEAC330-60		REAR WHEEL
EEAC330-61		REAR WHEEL RETAINER
EEAC330-67		REAR WHEEL CAP
EEAC330-113		REAR WHEEL AXLE

PART NUMBER	IMAGE	DESCRIPTION
EEAC330-66		TEMP. SENSOR
EEAC330-68		CABLE GUIDE
EEAC330-89		100cm COPPER HOSE
EEAC330-90		50cm COPPER HOSE
EEAC330-73		95cm BLUE HOSE W/BALL VALVE
EEAC3330-74		95cm RED HOSE W/BALL VALVE
EEAC330-72		3.8m BLUE HOSE
EEAC3300-71		3.8m RED HOSE
EEAC330-76		4X2.5 POLY TUBE
EEAC330-75		10m POLY HOSE
EEAC330-77		4X6 POLY HOSE
EEAC330-78		8X10 POLY TUBE
EEAC330-116		10mmX3/8 GAS ELBOW FITTING
EEAC330-97		R134a NIPPLE 1/8 GASX 1/2 ACME

PART NUMBER	IMAGE	DESCRIPTION
EEAC330-82		CHECK VALVE M1/4 SAE
EEAC330-83		CHECK VALVE M3/8 SAE
EEAC330-84		12 BAR SAFETY VALVE
EEAC330-85		1 BAR SAFETY VALVE
EEAC330-93		1/8 GAS X 1/4 SAE
EEAC330-95		M1/4 SAE X 3/8 SAE
EEAC334-48		6mm ELBOW FITTING
EEAC334-41		1/8 GAS FILTER FITTING
EEAC334-43		16mm HOSE FITTING
EEAC334-44		VACUUM PUMP OIL FILL TUBE
EEAC334-45		16mm HOSE FITTING
EEAC334-46		OIL FILLING CAAP
EEAC334-47		MOUNT ADPATER FITTING
EEAC334-49		OIL DRAIN CAP
EEAC334-56		COMPRESSION SPRING

SNAPON PART NUMBER	IMAGE	DESCRIPTION
EEAC330-94		TANK PLATE MAGNET
EEAC330-96		DRYER FILTER MANIFOLD
EEAC330-99		MAGNET FLARED HOLE
EEAC330A-1		TANK UNLOCK STICKER 1
EEAC330A-2		TANK UNLOCK STICKER 2
EEAC330A-3		LOCK UNLOCK KEY
EEAC330A-4		TANK CENTERING PIN
EEAC330A-5		TANK PLATE STOP SCREW
EEAC330A-6		TANK PLATE BALL PLUNGER
EEAC330-100		10mm SPACER SCALE
EEAC330-102		WARNER STICKER (EN)
EEAC330-103		WARNING STICKER (FR)
EEAC330-121		UL SWITCH STICKER
EEAC330-108		O-RING KIT FILTER DRYER
EEAC330-109		LUBE
EEAC330-112		O-RING 1/4 CAP SCREW

PART NUMBER	IMAGE	DESCRIPTION
EEAC330-132		12 PIN MOTHER BOARD CONNCTOR
EEAC330-120		POWER SUPPLY COVER
EEAC330-119		CONTROL PANEL FIXING BRACKET
EEAC330-118		OIL FILL BRACKET
EEAC330-117		1/8 X M24 FITTING
EEAC330-16		OIL DRAIN EXTENSION
EEAC331-27		STATUS LIGHT WIRING HARNESS
EEAC330-128		1/4 COPPER GASKET
EEAC330-129		3/8 COPPER GASKET



Notice: The information contained in this document is subject to change without notice. Snap-on Equipment makes no warranty with regard to this material. Snap-on Equipment shall not be liable for errors contained herein or for incidental consequential damages in connection with furnishings, performance, or use of this material.

This document contains proprietary information which is protected by copyright and patents. All rights are reserved. No part of this document may be photocopied, reproduced, or translated without prior written consent of Snap-on Equipment