



POLARTEK HYBRID

EEAC332

R134a Refrigerant
Recovery / Recycle / Recharge
Service Hybrid and Non-Hybrid
Vehicle A/C System



INTRODUCTION

Snap-on® Model No. EEAC332 is ETL Laboratories approved, in compliance with SAE J2788. We are dedicated to solving the issues surrounding the safe containment and proper management of refrigerants. Your new machine incorporates the latest technology and state of the art features to aid you in servicing R134a air conditioning and refrigeration systems. We hope you get as much enjoyment using this equipment as we did designing and building it.

INDEX

INDEX3

SAFETY5

SAFETY SIGNAL WORDS 5

SAFETY INFORMATION 5

EXPLOSION HAZARDS 5

HEAT/FREEZING HAZARDS 5

GENERAL SAFETY MESSAGES 6

FUME HAZARDS 6

ADDITIONAL SAFETY INFORMATION 6

HOSES CONNECTION 7

SAFETY DEVICES 7

REFRIGERANT AND LUBRICANT - PERSONAL

PROTECTIVE EQUIPMENT AND PRECAUTIONS..... 7

PRECAUTIONS FOR HANDLING AND USE OF R134a

FLUIDS 7

SETUP8

COUNTERS 8

LANGUAGE 8

MEASURE UNITS 8

PLATE NUMBER..... 8

QUICKSETUP..... 9

SET DATE / TIME..... 9

SETUP HEADER PRINT 9

VACUUM SETTINGS 9

INTRODUCTION 10

CERTIFICATION..... 10

ABOUT THIS MANUAL 10

ABOUT YOUR AIR CONDITIONING SERVICE CENTER 10

GENERAL INFORMATION 11

PRINCIPLES OF OPERATION 11

THE MACHINE 12

PLASTIC COVER..... 12

CONTROL PANEL..... 13

LIGHT SIGNALS 13

DISPLAY ICONS..... 13

BASIC COMPONENTS 14

ALARMS..... 15

ERROR MESSAGES 16

PRELIMINARY OPERATIONS 17

AUTOMATIC PROCEDURE..... 18

EDIT VACUUM DATA 18

EDIT CHARGE AMOUNT DATA 18

EDIT CHARGE MODE 18

START AUTOMATIC PROCEDURE 19

MANUAL PROCEDURE..... 21

RECOVERY/RECYCLING..... 21

VACUUM 22

FLUSHING HOSES..... 24

CHARGE..... 24

EDIT CHARGE DATA 24

EDIT CHARGE MODE 25

START PROCEDURE 25

SERVICES 26

SEARCH BY PLATE 26

SEARCH BY DATE..... 27

EXTRACT ARCHIVE 27

MAINTENANCE 28

A/C PRESSURES CHECK..... 28

AIR PURGE MANUAL..... 30

CALIBRATION..... 30

CHANGE DRYER FILTER..... 31

DATABASE 33

EMPTY HOSES 33

MAINTENANCE REPORT..... 34

SERVICES ARCHIVE..... 34

TANK CELL CHECK..... 34

TANK FILLING..... 35

VACUUM PUMP OIL CHANGE..... 36

VACUUM PUMP 36

EMPTYING THE USED OIL CONTAINER..... 38

REPLACING THE PRINTER PAPER 39

INFO..... 39

WARRANTY 40

NOTES 41

SAFETY

The following safety information is provided as guidelines to help you operate your new system under the safest possible conditions. Any equipment that uses chemicals can be potentially dangerous to use when safety or safe handling instructions are not known or not followed. The following safety instructions are to provide the user with the information necessary for safe use and operation. Please read and retain these instructions for the continued safe use of your service system.

SAFETY SIGNAL WORDS

All safety messages contain a safety signal word that indicates the level of the hazard. An icon, when present, gives a graphical description of the hazard.

Safety Signal words are:

Danger

Indicates an imminently hazardous situation which, if not avoided, will result in death or serious injury to the operator or to bystanders.

Warning

Indicates a potentially hazardous situation which, if not avoided, could result in death or serious injury to the operator or to bystanders.

Caution

Indicates a potentially hazardous situation which, if not avoided, may result in moderate or minor injury to the operator or to bystanders.

SAFETY INFORMATION

Every craftsman respects the tools with which they work. They know that the tools represent years of constantly improved designs and developments. The true craftsman also knows that tools are dangerous if misused or abused. To reduce risk of discomfort, illness, or even death, read, understand, and follow the following safety instructions. In addition, make certain that anyone else that uses this equipment understands and follows these safety instructions as well.

READ ALL SAFETY INFORMATION CAREFULLY before attempting to install, operate, or service this equipment. Failure to comply with these instructions could result in personal injury and/or property damage.

RETAIN THE FOLLOWING SAFETY INFORMATION FOR FUTURE REFERENCE.

Published standards on safety are available and are listed at the end of this section under ADDITIONAL SAFETY INFORMATION.

The National Electrical Code, Occupational Safety and Health Act regulations, local industrial codes and local inspection

requirements also provide a basis for equipment installation, use, and service.

The following safety alert symbols identify important safety messages in this manual.

When you see one of the symbols shown here, be alert to the possibility of personal injury and carefully read the message that follows.

EXPLOSION HAZARDS

Warning



Risk of explosion

- **Do not fill the tank to more than 80% of the maximum capacity.**

Explosion can cause death or personal injury.

HEAT/FREEZING HAZARDS

Warning



Risk of personal injury

- **Handle refrigerants and pressure vessels with caution.**
- **Wear safety glasses, gloves, and suitable clothing.**
- **Avoid contact with the skin.**
- **Avoid breathing A/C refrigerant and lubricant vapor mist.**

Contact with refrigerant can cause health risks, blindness, and other physical damage (frostbite) and possibly death.



Risk of personal injury and equipment damage

- **Always use an identifier before recovering refrigerant from a vehicle.**
- **Recover only the refrigerant the product was certified to be used with.**

Recovery of refrigerants other than the one the unit was certified for may cause injury, equipment damage and possible death. Alternate refrigerants may contain flammables such as butane or propane and can explode or cause a fire.



GENERAL SAFETY MESSAGES

⚠Warning



Risk of electric shock

- **Unplug unit before attempting any maintenance or cleaning.**
- **Do not operate unit with damaged cord or plug.**

Electric shock can cause injury or death.

⚠Warning



Risk of equipment or circuit damage

- **Always unplug equipment from electrical outlet when not in use.**
- **Never use the cord to pull plug from an outlet. Grasp the plug and pull it to disconnect.**
- **If an extension cord is necessary, a cord with a current rating equal to or more than the equipment should be used. Cords rated for less current may overheat.**
- **DO NOT adapt your unit for a different refrigerant — system failure will result. R134a systems have special fittings (per SAE specifications) to avoid cross contamination.**

Improper use of equipment can cause equipment or circuit damage.

⚠Warning



Risk of unexpected vehicle movement

- **Block drive wheels with chocks before performing a test with engine running.**
- **Unless instructed otherwise, set parking brake, and put gear selector in neutral or park.**
- **If the vehicle has an automatic parking brake release, disconnect the release mechanism for testing and reconnect when finished.**
- **Do not allow bystanders to stand in front of or behind the vehicle while testing.**
- **Do not leave a running engine unattended.**

A moving vehicle can cause death or serious injury.

⚠Warning



Risk of personal injury

- **Keep yourself, clothing and other objects clear of hot or moving parts.**
- **Keep hoses and cords clear of moving parts.**
- **Do not wear watches, rings, or loose clothing when working in an engine compartment.**

Contact with hot or moving parts can cause injury.

FUME HAZARDS

⚠Warning



Risk of fume, gas, and vapor hazards

- **Avoid breathing A/C refrigerant and lubricant vapor mist.**
- **Always perform vehicle service in a properly ventilated area.**
- **Never run an engine without proper ventilation for its exhaust.**

Fume, gas, and vapors can cause irritation to eyes, nose, and throat, cause illness or death.

ADDITIONAL SAFETY INFORMATION

For additional information concerning safety, refer to the following standards.

ANSI Standard Z87.1 — SAFE PRACTICE FOR OCCUPATION AND EDUCATIONAL EYE AND FACE PROTECTION - obtainable from the American National Standards Institute, 11 West 42nd St., New York, NY 10036, Telephone (212) 642-4900, Fax (212) 398-0023 - www.ansi.org

⚠Caution



Risk of ventilation hazards

- **Must have at least four air changes per hour or equipment should be located at least 18" (457 mm) above the floor.**

Poor ventilation can cause irritation to eyes, nose, and throat, illness, or death.



Risk of explosion

- **Do not pressure test or leak test R134a equipment and/or vehicle air conditioning systems with compressed air.**

Explosion can cause injury or death.

NOTE: Use only new lubricant to replace the amount removed during the recycling process. Used lubricant should be discarded per applicable federal, state, and local requirements.

The manufacturer shall not be responsible for any additional costs associated with a product failure including, but not limited to, loss of work time, loss of refrigerant, cross contamination of refrigerant, and unauthorized shipping and/or labor charges.

Danger

Risk of explosion



- **Ensure that you are only recovering from the fitting on the AC system.**
- **Some car manufacturers on the fuel intake manifold install a connector identical to the A/C low pressure fitting.**

Explosion can cause injury or death.

Warning

Risk of personal injury



- **Do not operate equipment with damaged cord or hoses.**
- **Do not operate the unit if it has been damaged until it has been examined by a qualified service personnel.**

Damaged parts can cause injury or death.

HOSES CONNECTION

Hoses may contain refrigerant under pressure. Before disconnecting the quick coupler verify the corresponding pressure in the service hoses (gauge).

SAFETY DEVICES

The machine is equipped with the following safety devices:

SAFETY PRESSURE SWITCH: Stops the compressor in case of excessive pressure.

SAFETY VALVE: Opens when the pressure inside the system reaches a level of pressure above the estimated limits.

MAIN SWITCH: Connects and disconnects machine AC electrical power. Disconnect main power cord from electrical power source before servicing.

ANY KIND OF TAMPERING OF THE SAFETY DEVICES MENTIONED ABOVE IS NOT ALLOWED.

REFRIGERANT AND LUBRICANT - PERSONAL PROTECTIVE EQUIPMENT AND PRECAUTIONS

Warning

Risk of personal injury



- **Handle refrigerants and pressure vessels with caution.**
- **Wear safety glasses, gloves, and suitable clothing.**
- **Avoid contact with the skin.**

Contact with refrigerant can cause health risks, blindness, and other physical damage (frostbite).



Risk of equipment damage and personal injury

- **Should be operated by certified personnel.**
- **Do not remove the seals of the safety valves and control systems.**
- **Do not use external tanks or other storage containers that are not approved.**
- **Do not block air vents and ventilation equipment.**

Improper use of equipment can cause equipment damage and personal injury.



PRECAUTIONS FOR HANDLING AND USE OF R134a FLUIDS

Warning

Risk of personal injury. Risk for handling pressurized R134a containers

- **Avoid inhaling highly concentrated vapors.**
- **Avoid use of R134a near open flames and incandescent elements.**
- **Wear protective garments such as to ensure that no jets of liquid or gas can come into contact with the skin.**
- **Wear goggles to avoid contact with the eyes.**
- **Avoid dispersing the R134a refrigerant fluid utilized in the machine into the atmosphere.**

Mishandling of pressurized R134a containers can cause loss of Consciousness, injury or death.

SETUP

From the MAIN MENU:

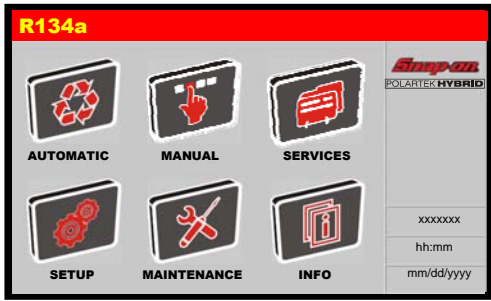

Select the SETUP, the following screen will be displayed:

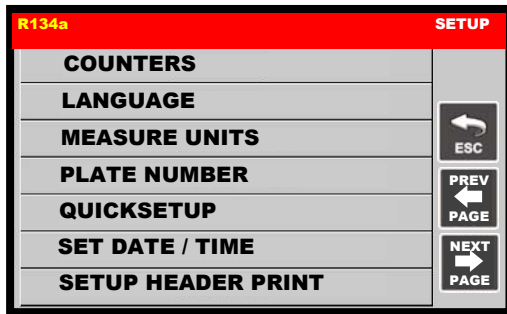

COUNTERS

From the SETUP MENU, select COUNTERS, the following screen is displayed:

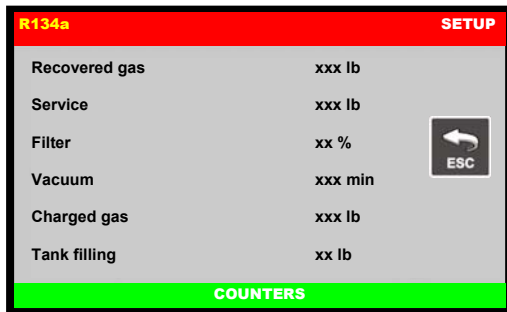

This screen displays the total values for: gas recovered, service alarm counters, filter status, total vacuum time (minutes), gas injected, and gas recovered in the internal tank using the "Tank filling" function.

LANGUAGE

From the SETUP, select LANGUAGE :



NOTE: Current language is indicated by red dot.

Select a language, the unit will change the language in few seconds.

MEASURE UNITS

From the SETUP MENU, select MEASURE UNITS, the following screen is displayed:

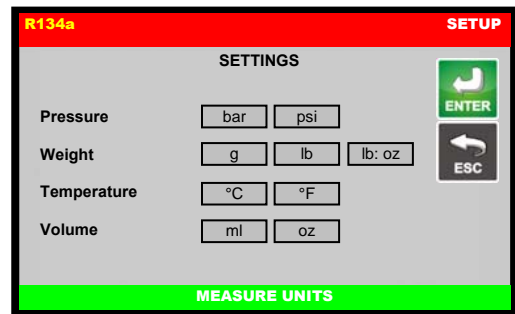

Select the unit of measurement to change, then select between international system of units (SI) and imperial system units (IMP).

When finished press ENTER to exit. The machine will reboot to update measure units.

PLATE NUMBER

From the SETUP MENU, select PLATE NUMBER, the following screen is displayed:

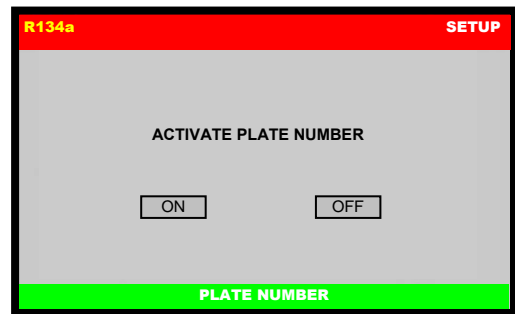

Select ON to visualize insert plate screen during automatic or manual procedures, or OFF to skip this screen.

QUICKSETUP

The first time the machine is used, a quick startup guide appears: the operator is guided through the steps described at the start of the PRELIMINARY OPERATIONS section. From the SETUP MENU, select QUICKSETUP, the following screen is displayed:



Press ENTER to proceed with QUICKSETUP, the user will be guided through the following steps:

- Language selection
- Measure units selection
- License plate recording
- Date and time selection
- Setup header print
- Vacuum settings
- Leak check test
- Tank filling

Follow the instructions displayed. At the end of the procedure, press ENTER to print a summary report of the guided procedure. Press ESC to exit.

NOTE: If the guided procedure is not completed, it will be displayed again the next time the machine is switched on.

NOTE: To display the QUICKSETUP at any time, select from the menu of the same name under SETUP.

SET DATE / TIME

The machine keeps date and time settings even if it is not used for around one year. From the SETUP MENU, select SET DATE / TIME:

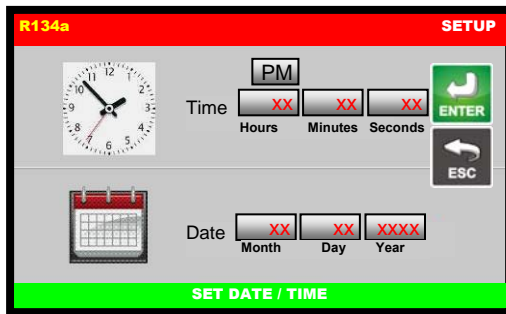

Use keypad to change date and time. Press ENTER to confirm, or press ESC to return to SETUP menu without saving the changes.

For example, to insert the date January 21st 2015, select the month then type "1" using the keypad, select the day then type "21" using the keypad, select the year then type "2015" using the keypad; press ENTER to confirm and exit.

SETUP HEADER PRINT

The printout can be personalized by entering 4 lines containing the workshop's details (e.g. name, address, telephone number and e-mail).

From the SETUP, select SETUP HEADER PRINT:



Use the keypad to modify the 4 lines, then press ENTER to return to SETUP menu.

NOTE: the numerical keys include an alphabet that is used similar to text messaging; for example: press "2" once to display "2", twice to display "A", three times for "B", four times for "C", five times for "a", six times for "b", seven times for "c", eight times for "2" again.

VACUUM SETTINGS

Allows to modify the default vacuum time and the default time of check.

From the SETUP, select VACUUM SETTINGS, default setting is displayed:

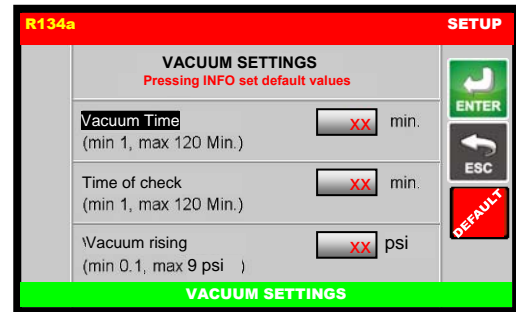

Each value can be modified, within the values shown in parentheses.

NOTE: Press DEFAULT to restore default values:

- Vacuum time 25 min
- Time of check 2 min
- Vacuum rising 1 psi

INTRODUCTION

Snap-on® Model No. EEAC332 is ETL Laboratories approved, in compliance with SAE J2788. We are dedicated to solving the issues surrounding the safe containment and proper management of refrigerants. Your new machine incorporates the latest technology and state of the art features to aid you in servicing R134a air conditioning and refrigeration systems. We hope you get as much enjoyment using this equipment as we did designing and building it.

CERTIFICATION

All technicians opening the refrigeration circuit in automotive air conditioning systems must now be certified in refrigerant recovery and recycling procedures to be in compliance with Section 609 of the Clean Air Act Amendments of 1990. For information on certification call MACS Worldwide at (215) 631-7020.

ABOUT THIS MANUAL

⚠CAUTION



This manual includes a safety summary, machine preparation for use, operation procedures, and maintenance instructions, for your Air Conditioning Service Center.



Anyone intending to use the machine should become familiar with ALL the information included in this manual (especially the safety summary) before attempting to use it.

Before operating this machine for the first time, perform all preparation for use instructions.

If your new machine is not properly prepared to perform a service, your service data could be erroneous. In order to properly perform a complete air conditioning service, follow all procedures in the order presented. Please take the time to study this manual before operating the machine. Then keep this manual close at hand for future reference. Please pay close attention to the safety summary and all warnings and cautions provided throughout this manual. To activate the published warranty, mail the attached warranty card.

⚠CAUTION



The machine is intended for indoor use only.

ABOUT YOUR AIR CONDITIONING SERVICE CENTER

Your machine incorporates a highly accurate electronic scale for determining charging weights, etc. Other functions can also be performed with the electronic scale as you will discover during the operating procedures. Either standard or metric units of measure can be selected. This machine is a piece of equipment designed to recover R134a from air conditioning systems (A/C) for vehicles, to operate within the objectives of the Montreal Protocol.

GENERAL INFORMATION

Machine model information are printed on the data plate (see Fig. 1). Overall machine dimensions:

Height:	47" (120 cm)	
Width:	25" (64 cm)	
Depth:	25" (64 cm)	
Weight:	200 lbs (90 kg)	
Operating temperature	50/122°F	(10/50°C)
Storage temperature	-13/122°F	(-25/50°C)

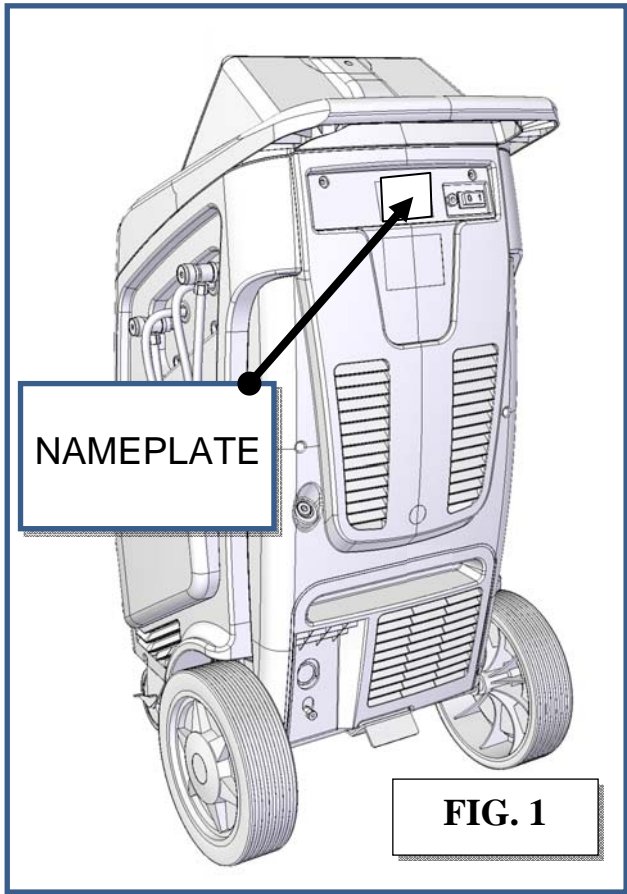

Like any equipment with moving parts, the machine inevitably produces noise. The construction system, panelling, and special provisions adopted by the Manufacturer are such that during work, the average noise level of the machine is not in excess of 64 dB (A).

PRINCIPLES OF OPERATION

In a single series of operations, the machine permits recovering and recycling R134a refrigerant fluids with no risk of releasing the fluids into the environment, and also permits purging the A/C system of humidity and deposits contained in the oil.

The machine is in fact equipped with a built-in evaporator/separator that removes oil and other impurities from the refrigerant fluid recovered from the A/C system and collects them in a container for that purpose.

The fluid is then filtered and returned perfectly recycled to the tank installed on the machine.

The machine also permits running certain operational and seal tests on the A/C system.

THE MACHINE

PLASTIC COVER

Refer to Fig. 4a .

1) Upper plastic body

2) Frontal body shell

Disassembly: Screw off 6 screws marked (+)

3) Right side body shell

Disassembly: Remove frontal and rear body shell, both right doors and then screw off 8 screws marked (+)

4) Right upper door

5) Right bottom door

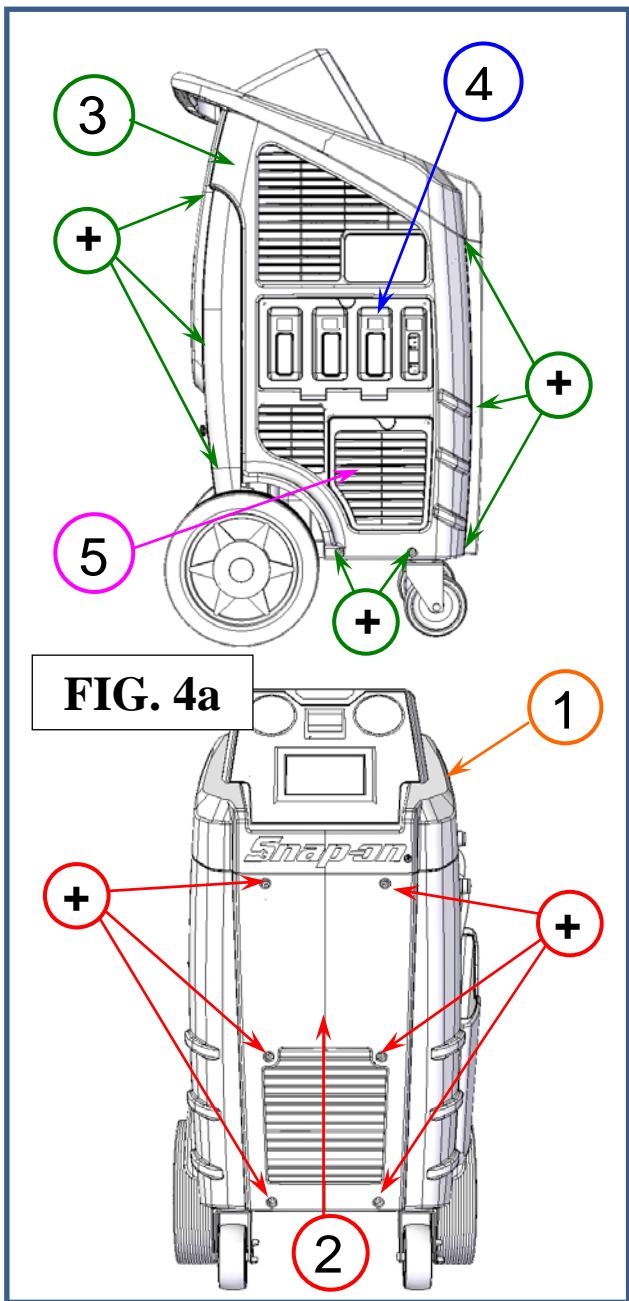

Refer to Fig. 4b.

6) Rear body shell

Disassembly: Remove rear bottom door, then screw off 6 screws marked (+)

7) Left side body shell

Disassembly: Remove frontal and rear body shell, then screw off 10 screws marked (+)

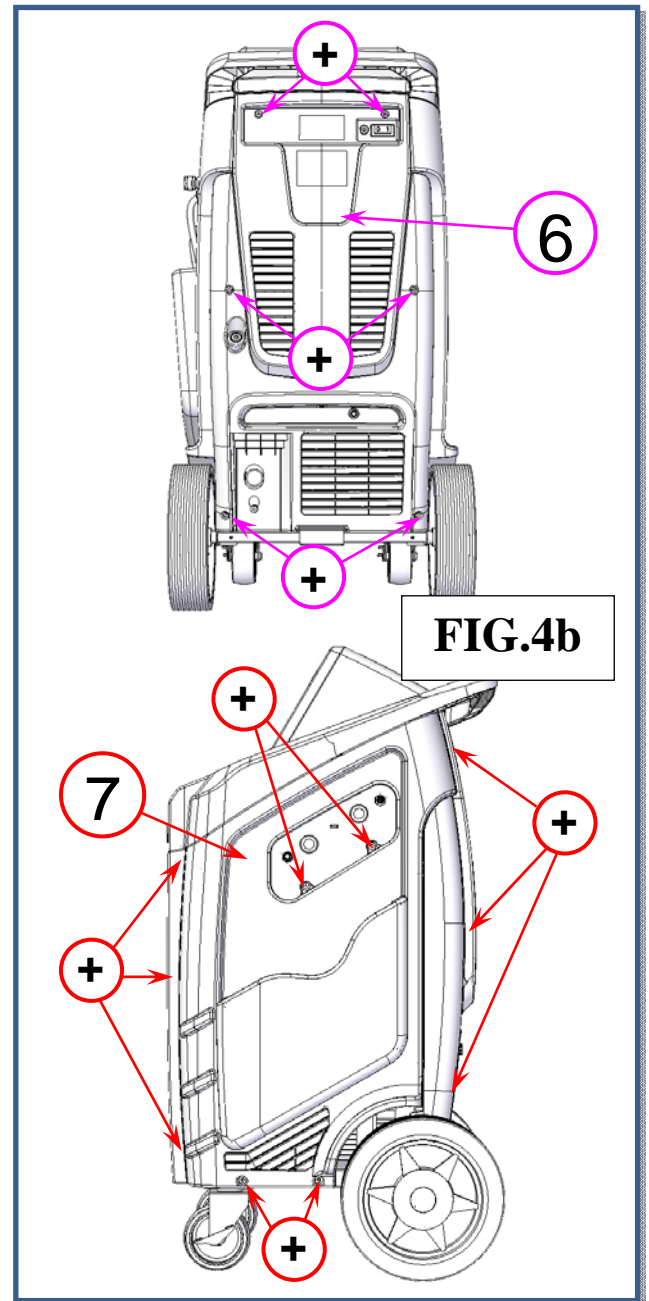

CONTROL PANEL

Refer to Fig. 5:

- 1) Low pressure gauge
- 2) High pressure gauge
- 3) Printer
- 4) 7" touch color display
- 5) Tool tray
- 6) Status light

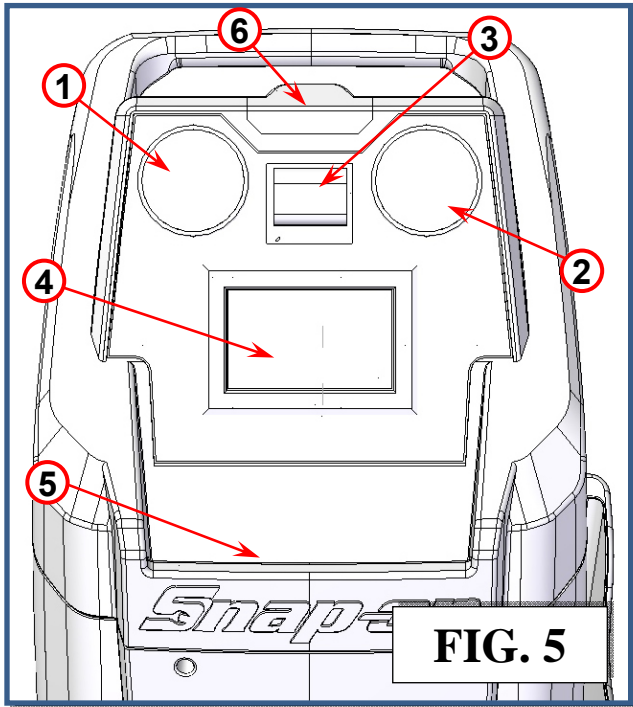

DISPLAY ICONS

ICON	DESCRIPTION
	AUTOMATIC PROCEDURE: Activates a menu that helps the user set up an automatic recover/vacuum/leak test/charge sequence
	MANUAL PROCEDURE: Activates a menu that helps the user to perform a manual operation
	RECOVERY: Activates a menu that helps the user to perform a recovery/recycling phase
	VACUUM: Activates a menu that helps the user to perform a vacuum phase
	FLUSHING HOSES: Activates a menu that helps the user to perform a flushing hoses
	CHARGE: Activates a menu that helps the user to perform a gas charge phase
	SERVICES: Activates services menu
	SETUP: Activates the setup menu of the service station
	MAINTENANCE: Activates the maintenance menu of the service station
	INFO: Activates a menu that contains all the information of the service station
	STOP: Terminates a procedure or operation, silences the audible alarm or returns to the previous screen
	ENTER: Confirm a procedure or operation shown on the display
	ESC: Return back to previous menu
	DATABASE: Activate database menu
	KEYPAD: Numerical keypad (includes an alphabet that is used to text messaging)
	PRINTER: To print the receipt of the procedure

LIGHT SIGNALS

The machine is provided with a STATUS Light (ref 6, Fig. 5).

Light signals are the following:

- GREEN (STEADY): Unit ready
- GREEN (FLASHING): Action completed
- YELLOW: Unit working
- RED: Needs attention or there is a problem

BASIC COMPONENTS

Refer to Fig. 7, Fig. 8, Fig. 9, Fig. 10:

- a) Handle
- b) Rear wheel
- c) Front swirling wheel
- d) Filter dryer panel access
- e) Used oil container
- f) Capsizable control panel
- g) Status light
- h) Tool tray
- i) Ventilation grid
- j) Service hoses pocket
- k) Oil pump filling cap
- l) Drive up pedal
- m) Magnet for reference weight
- n) Circuit breaker
- o) Power cord exit
- p) HP service hose outlet
- q) HP quick connection
- r) USB port
- s) LP service hose outlet
- t) LP quick connection

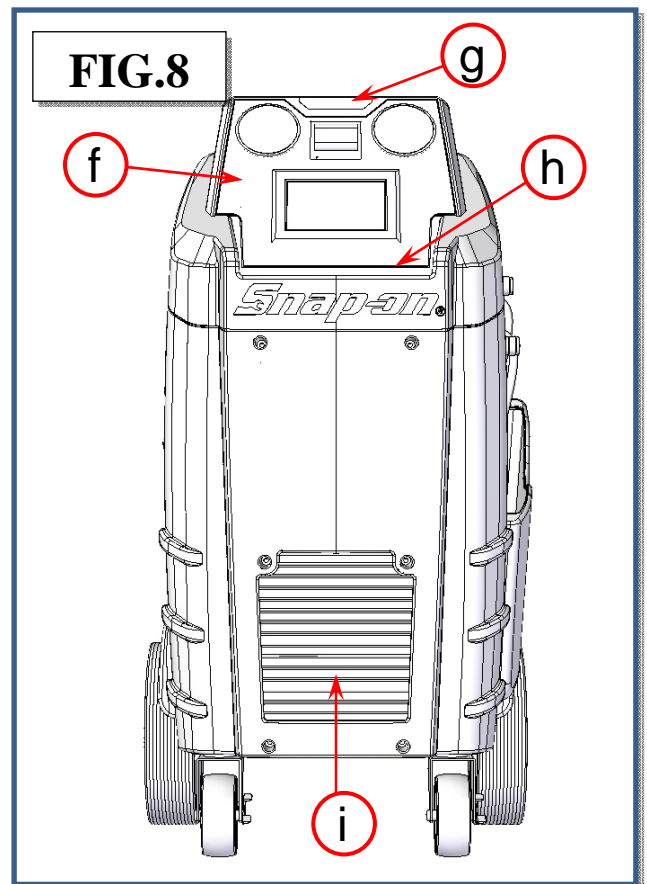
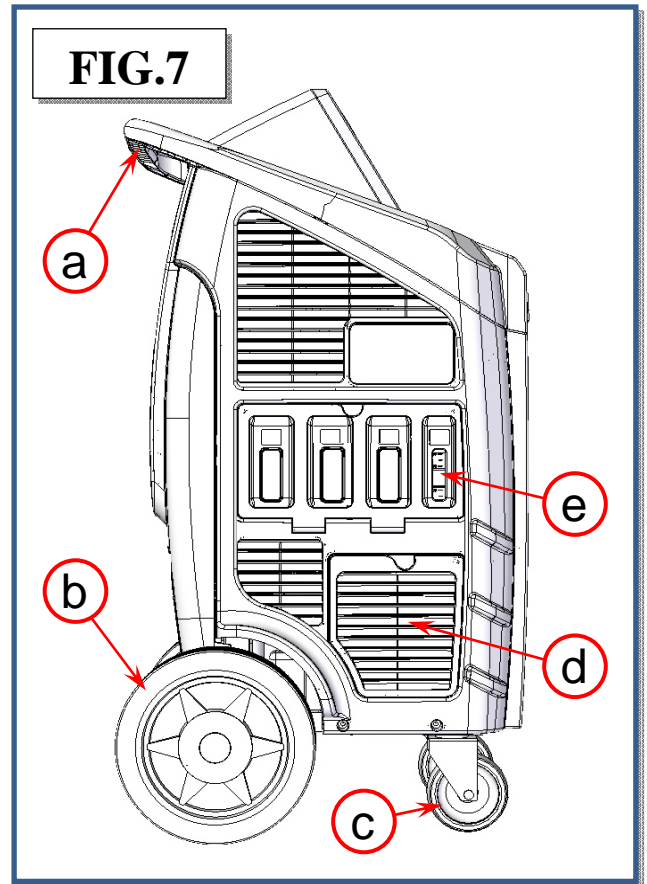

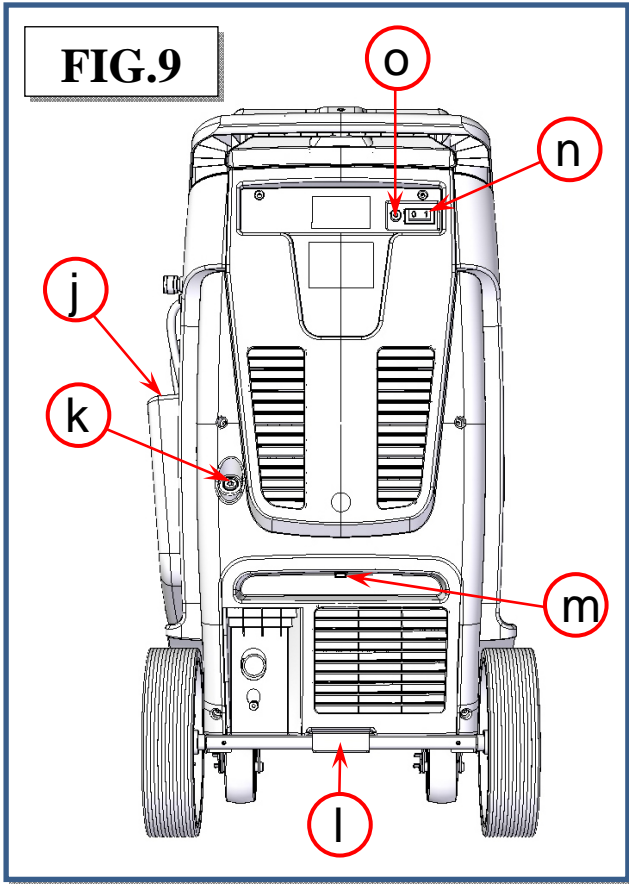

ALARMS

HIGH PRESSURE ALARM: Beeper advises when the pressure of the fluid in the circuit is too high 290 psi (20 bar). The recovery operation is automatically interrupted.

FULL TANK ALARM: Beeper advises when the tank is filled to more than 80% of maximum capacity, 24 lbs (10.9 kg). The RECOVERY operation is automatically interrupted (to cancel this alarm, charge one or more A/C systems before recovering any more refrigerant).

EMPTY TANK ALARM: Beeper advises when the quantity of refrigerant fluid contained in the tank is low, less than 3 lbs (1.36 kg).

VACUUM PUMP OIL CHANGE: Beeper advises after 15 hours of work of the vacuum pump; change the oil of the vacuum pump.

SERVICE ALARM: Beeper advises whenever the total recovered refrigerant amounts to 155 lbs (70 kg). To deactivate the alarm, replace the filters and the vacuum pump oil. A code for canceling the alarm is supplied with the spare filters.

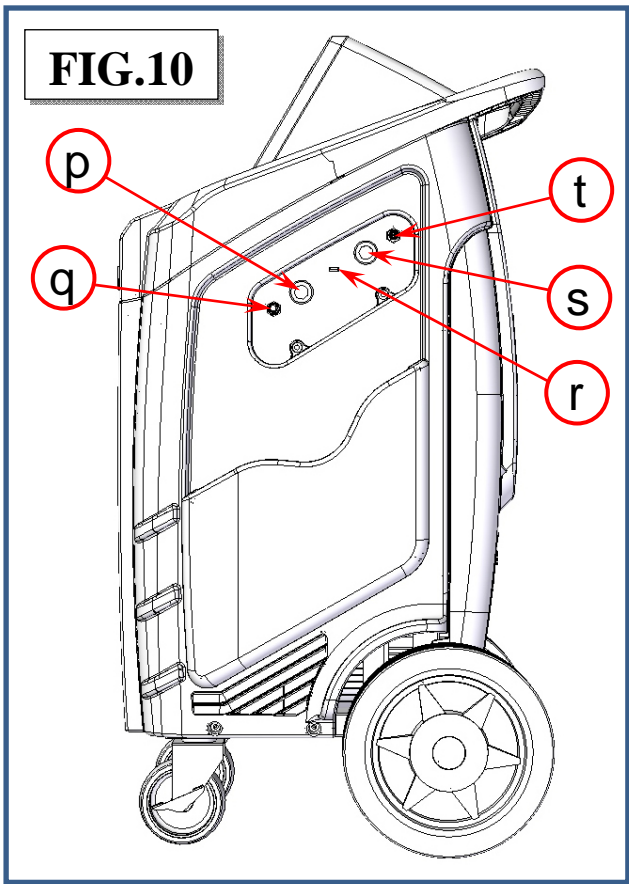

ERROR MESSAGES

SYSTEM LEAKS: Error message displayed when the AC system connections are not tight.

Solution: Verify the connections between the service hoses and quick couplers, and make another 5 min vacuum test only on service hoses. If the problem persists, delete the residual oil in the service hoses making a short 4 oz (100 g) charge in the service hoses and then a recovery, and repeat the 5 minutes vacuum test on service hoses.

NOTE: If the vacuum test on service hoses passes, means that the A/C system has a leak which must be localized using a leak detector.

PRESENCE OF REFRIGERANT INTO THE A/C SYSTEM: Error message displayed when starting the vacuum, the charging station checks the presence of a pressure inside the A/C system.

Solution: Perform a recovery procedure.

LOW VACUUM: Error message displayed before charge if the value of the vacuum > 400mbar.

Solution: Perform a quick vacuum procedure (at least 20 minutes).

LOW GAS AVAILABILITY: Error message displayed during charge, when you select a quantity greater than the availability of gas.

Solution: Fill the inner refrigerant tank, refer to the Tank Filling section of the user manual.

SYSTEM EMPTY: Error message appears when you select a recovery procedure, but is not found pressure in the A/C system.

Solution: Check the connection and closing of the quick couplers. If after all these checks, the machine continues to give the same error, means that the A/C system is empty.

SET QUANTITY LOWER THEN 4 oz (100 g): Error message displayed during charge when the amount of gas typed is less than 4 oz (100 g) (both automatic and manual procedure).

Solution: Set a quantity of gas greater than or equal to 4 oz (100 g).

CHECK CONNECTIONS: Error message displayed when the flow rate of charge is too low.

Solution: Verify the correct opening of the quick couplers. Make sure that the amount of gas in the refrigerant tank is > 3 lbs (1.36 kg), otherwise fill the inner refrigerant tank.

Rarely, it may happen that the temperature of the engine compartment of the vehicle is too high compared to that of the charging station. This can cause an immediate balance between the refrigerant tank pressure and A/C pressure causing a slowdown or interruption of the charge. To avoid this, it is recommended not to fill A/C in a vehicle exposed to the sun or a vehicle with the engine running.

EMPTY EXTERNAL TANK: Error message appears during the process of charge the refrigerant tank when the pressure drops to zero before the completion of the procedure.

Solution: Check the connections, quick couplers and valves on the external tank; if the external tank is empty, replace it with a full one. Then run another charge.

HIGH PRESSURE ALARM: Error message appears during the recovery procedure, internal tank filling, empty hoses, or flushing hoses, this occurs when the hydraulic pressure reaches approximately 290 psi (20 bar). The causes may be:

Ambient temperature where is located in the station is too high.

Solution: To wait for a sufficient time to cool the charging station before resuming the interrupted procedure.

Number of services performed by the station is excessive.

Solution: To wait for a sufficient time to cool the charging station before resuming the interrupted procedure.

One of the taps of the internal tank is closed.

Solution: To open the tap and resume the interrupted procedure.

PRELIMINARY OPERATIONS

Check that the main switch (ref 1, Fig. 11) is set to O. Connect the machine to the electrical supply and switch on.

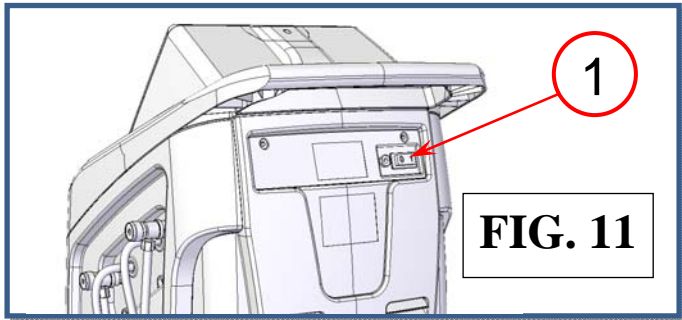

Check that the oil level in the used oil container is < 6.8 Oz (200 cc). If necessary empty it as described in ordinary maintenance section.

Check on the machine display that there are at roughly 4.4 lb (2 kg) of refrigerant in the tank. Should this not be the case, fill the on-board machine tank from an external tank of appropriate refrigerant following the procedure described in the tank filling (maintenance menu).

Check that the vacuum pump oil level indicator (ref 3, Fig. 12) shows at least one-half full. If the level is lower, add oil as explained in the maintenance section.

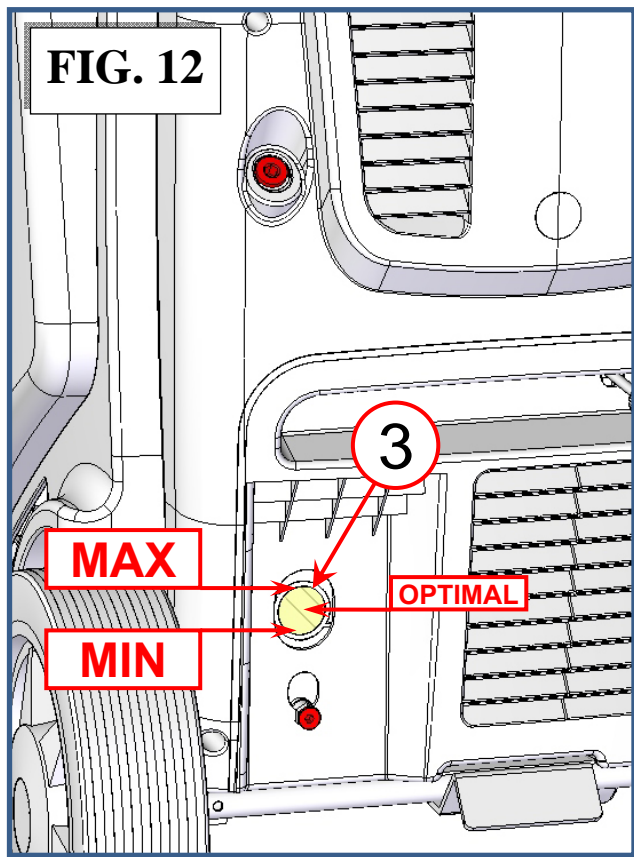

AUTOMATIC PROCEDURE

In the automatic mode, all the operations are performed automatically: recovery and recycling, oil discharge, vacuum, new oil reintegration, and charging. The values for the quantity of gas recovered, quantity of oil recovered, vacuum time, quantity of oil reintegrated, and quantity of gas charged into the system are automatically printed at the end of each single operation.

Before the automatic procedure, start the vehicle engine with the hood closed (the air conditioner must switch OFF) for 10 minutes to warm the engine. Switch off the vehicle engine.

Connect the hoses to the A/C system with the quick-connect couplings bearing in mind that BLUE must be connected to the low-pressure side and RED to high pressure. If the A/C system is equipped with a single quick-connect coupling for high or low pressure, connect only the relative hose.

From the MAIN MENU:

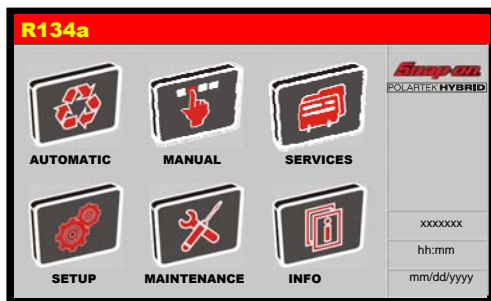

Select the AUTOMATIC PROCEDURE, the following screen will be displayed:

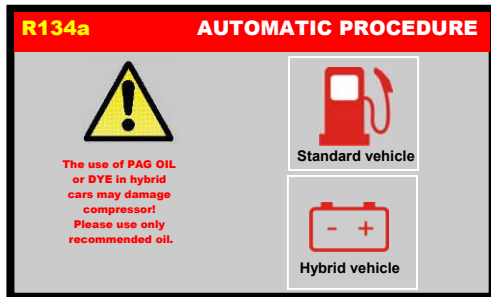

If HYBRID VEHICLE is selected the machine will perform FLUSHING HOSES (Refer to Manual Procedure section, pg 24, FLUSHING HOSES), then the following screen will be displayed:

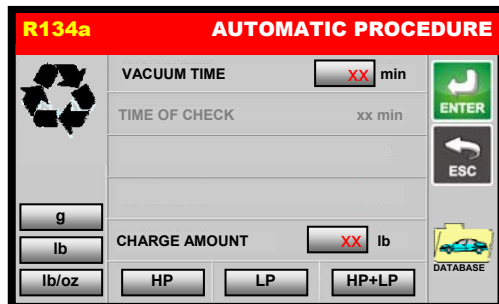

NOTE: press g, lb, or lb/oz to change the weight measurement units.

NOTE: select value box, then use the keypad to modify procedure parameters, press ENTER to confirm.

EDIT VACUUM DATA

Select VACUUM TIME value box. Use the KEYPAD to insert the new value of the VACUUM TIME. Press ENTER to confirm, ESC to return back.

NOTE: Use the VACUUM SETTING to change the duration of the TIME OF CHECK.

NOTE: If selected VACUUM TIME is lower than 15 minutes the following popup warning will be displayed:

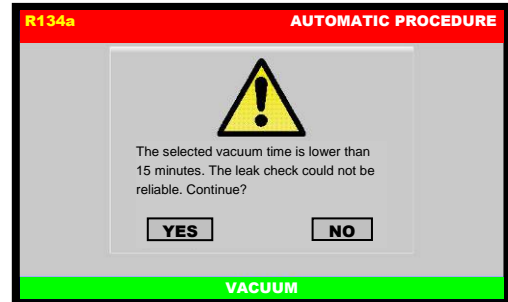

Press YES to continue, or press NO to go back.

EDIT CHARGE AMOUNT DATA

NOTE: For most systems the quantity of fluid to be refilled is indicated on a plate that is in the vehicle's engine compartment. If this quantity is not known, look for it in the relevant manuals.

Select CHARGE AMOUNT value box, then use the keys 0 to 9 to type the quantity of refrigerant to be charged into the A/C system.

NOTE: If DATABASE is installed, it can be used to insert the value of refrigerant into the CHARGE field.

NOTE: If charge amount is lower than 4 oz (100 g) the following popup warning will be displayed:

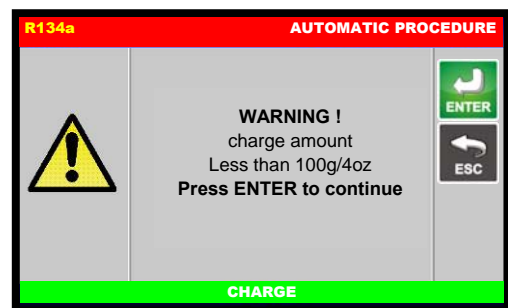

Charge amount lower than 4 oz (100 g) is not allowed, press ENTER then re-enter a higher CHARGE AMOUNT value.

EDIT CHARGE MODE

Select the connection mode:

- HP+LP fill the refrigerant from both HP and LP service ports.
- HP to fill the refrigerant only from the HP service port.

- LP to fill the refrigerant only from the LP service port.

START AUTOMATIC PROCEDURE

After selected all the procedure data, press ENTER to continue. If plate number is enabled, the following screen will be displayed:

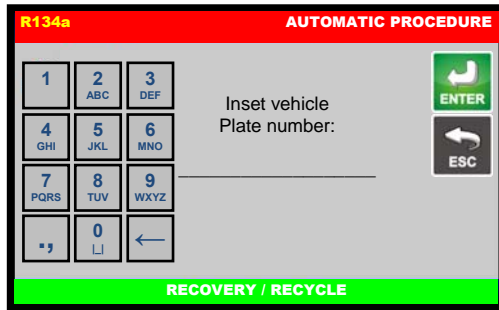

Type the plate of the car, press ENTER to confirm. ESC to return back.

NOTE: the numerical keys include an alphabet that is used similar to text messaging; for example: press "2" once to display "2", twice to display "A", three times for "B", four times for "C", five times for "a", six times for "b", seven times for "c", eight times for "2" again.

Then SUMMARY SCREEN will be displayed:

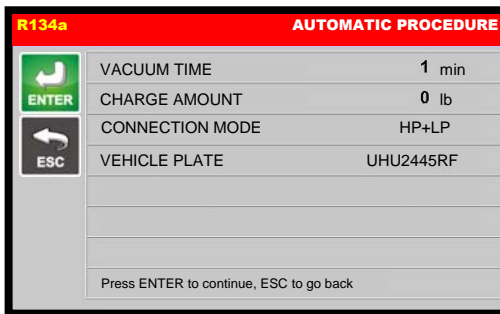

Press ENTER to confirm the displayed values and start the procedure. ESC to return back.

The following screen will be displayed:

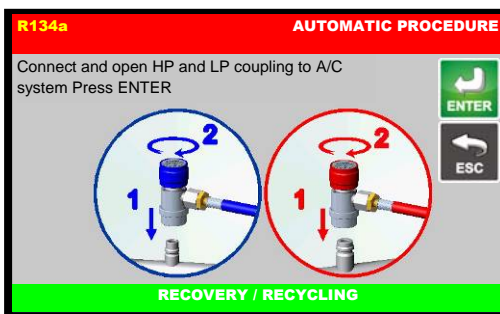

Connect and open the coupling to the A/C system, then press ENTER. Press ESC to return back.

The AUTOMATIC PROCEDURE will start, and the following screen will be displayed:

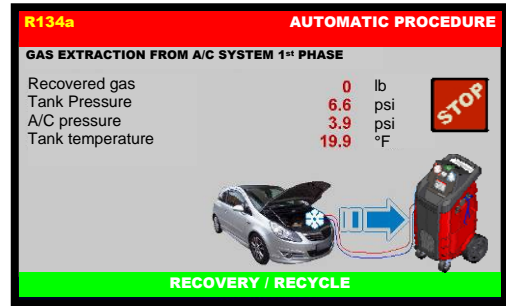

During the recovery phase, the machine displays the quantity of refrigerant recovered. Upon completion of recovery, the machine will stop and discharge, while automatically displaying the used oil extracted from the A/C system during the recovery phase.

The oil discharge operation lasts 4 minutes.

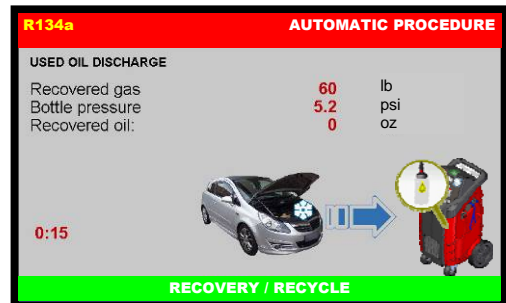

Completed the recovery phase, the machine automatically goes on to running the vacuum phase for the preset time:

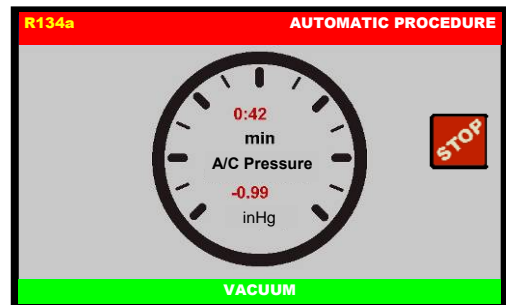

At the end of this phase, the machine will test for leaks in the A/C system:

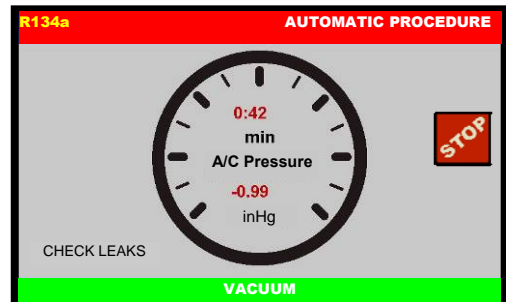

(WARNING! If vacuum time < 15 minutes this test is not reliable). If leaks are found, the machine will stop automatically and display the A/C SYSTEM LEAKS alarm.

Detection of micro-leaks is not guaranteed.

NOTE: The air purge is made automatically during the vacuum phase, or when the machine is in stand by for 3 minutes always automatically.

However air purge can always be made at any time manually by the AIR PURGE MANUAL selection from MAINTENANCE menu.

Upon completion of the vacuum phase, the system will go on to charging with the preset quantity of refrigerant.

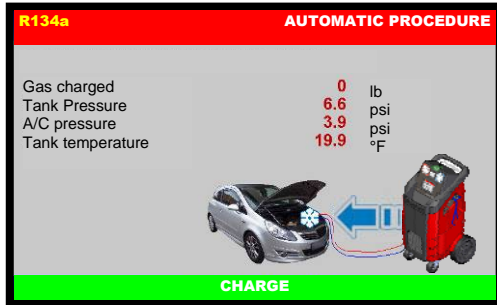

Then the following screen will be displayed:

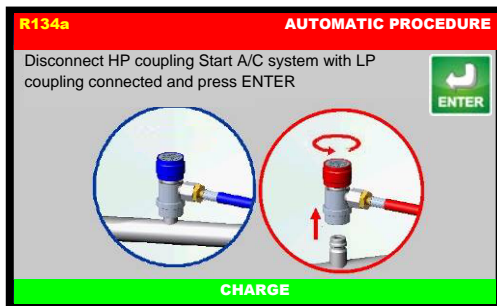

Disconnect HP coupling, Start A/C system with LP coupling connected, press ENTER.

The A/C system will recover the refrigerant into the service hoses, then the following screen will be displayed:

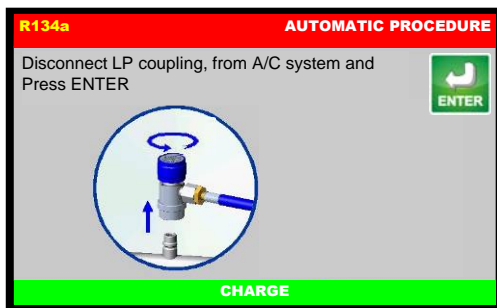

Disconnect LP coupling from A/C system, then press ENTER to continue:

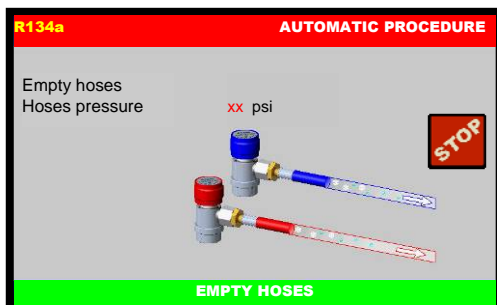

The machine will recover the residual refrigerant into the service hoses, then the following screen will be displayed:

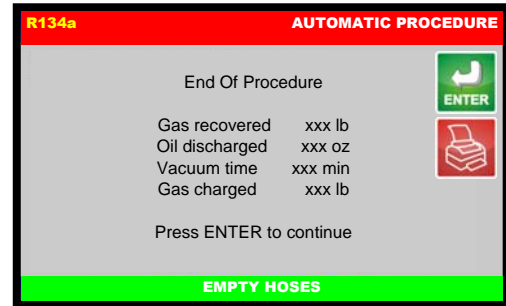

Procedure is now successfully completed.

Press PRINTER to print the receipt of the procedure. Press ENTER to exit.

NOTE: The automatic procedure may be run even if the A/C system is empty. In this case, the machine will begin with the vacuum phase.

MANUAL PROCEDURE

In the MANUAL PROCEDURE, all the operations can be performed individually with the exception of the recovery/recycling phase, which is automatically followed by used oil discharge.

The values for the quantity of gas recovered, quantity of oil recovered, vacuum time, and quantity of gas charged into the system are printed at the end of each single operation.

From the MAIN MENU:



Select the MANUAL PROCEDURE, the following screen will be displayed:

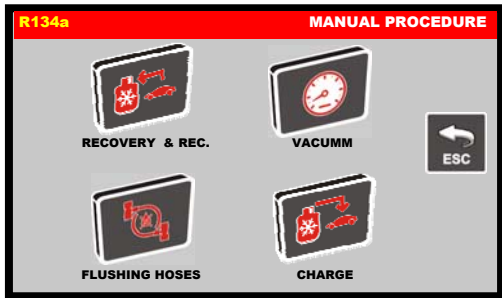

RECOVERY/RECYCLING

Before the recovery, start the vehicle engine with the hood closed (the air conditioner must switch OFF) for 10 minutes to warm the engine. Switch off the vehicle engine.

Connect the hoses to the A/C system with the quick-connect couplings, bearing in mind that BLUE must be connected to the low-pressure side and RED to high pressure.

If the A/C system is equipped with a single quick-connect coupling for high or low pressure, connect only the relative hose.

From MANUAL PROCEDURE, select RECOVERY/ RECYCLING, the following screen will be displayed:

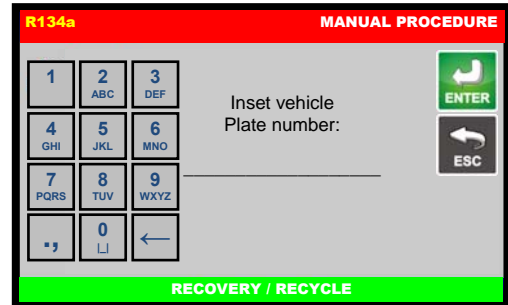

Type the plate of the car, press ENTER to confirm. ESC to return back.

NOTE: the numerical keys include an alphabet that is used similar to text messaging; for example: press "2" once to display "2", twice to display "A", three times for "B", four times for "C", five times for "a", six times for "b", seven times for "c", eight times for "2" again.

The following screen will be displayed:

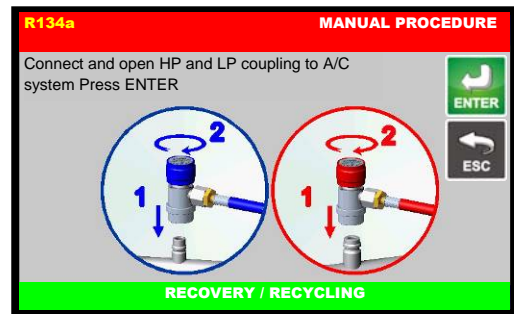

Connect and open the coupling to the A/C system, then press ENTER. Press ESC to return back.

The following screen will be displayed:

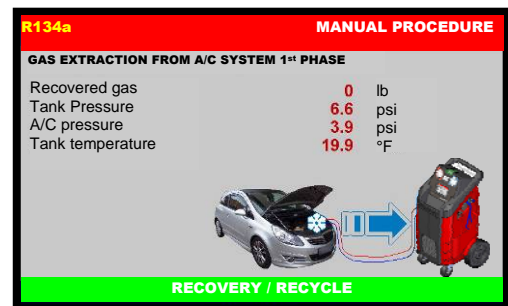

During the recovery phase, the machine displays the quantity of refrigerant recovered.

Upon completion of recovery, the machine will stop and discharge, while automatically displaying the used oil extracted from the A/C system during the recovery phase. The oil discharge operation lasts 4 minutes.

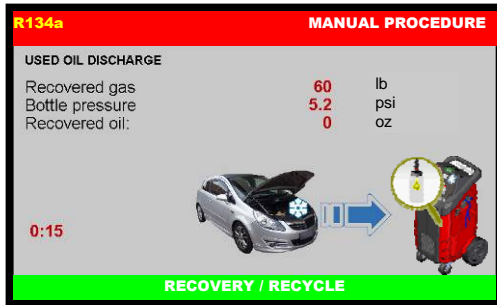

The machine checks whether or not there is air in the tank and, if necessary, purges the non-condensable gas. The machine will automatically discharge any non-condensable gas.

Allowing the machine to fully complete the procedure will reduce the risk of return flows, which may cause excessive non-condensable gas to be recharged into the air conditioning system. If any residual refrigerant in the A/C system should increase in pressure during this phase, the machine will automatically begin recovering the refrigerant.

Then the machine sounds an alarm while the following screen is displayed:

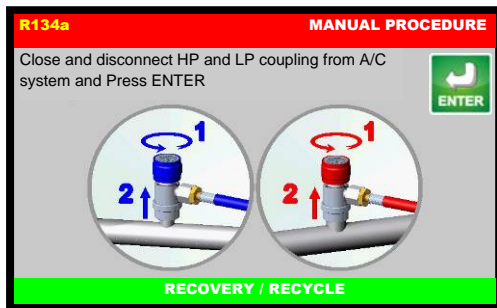

Close and disconnect HP and LP coupling from A/C system, then press ENTER, the following screen will be displayed:

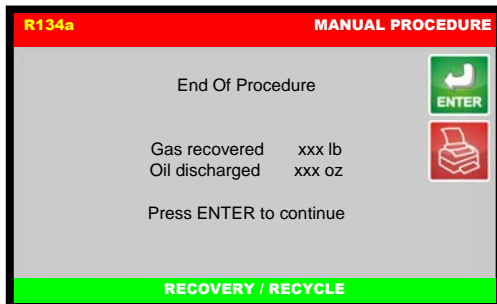

Procedure is now successfully completed.

Press PRINTER to print the receipt of the procedure. Press ENTER to exit.

VACUUM

Use the quick-connect couplings to connect the hoses to the A/C system, bearing in mind that BLUE must be connected to the low pressure side and RED to high pressure. If the system is equipped with a single quick-connect coupling for high or low pressure, connect only the relative hose.

From the MANUAL PROCEDURE, select VACUUM, the following screen will be displayed:

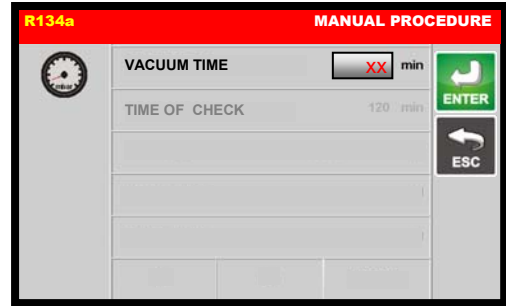

Select VACUUM TIME value box. Use the KEYPAD to insert the new value of the VACUUM TIME. Press ENTER to confirm. ESC to return back.

NOTE: Use the VACUUM SETTING to change the duration of the TIME OF CHECK.

NOTE: If selected VACUUM TIME is lower than 15 minutes the following popup warning will be displayed:

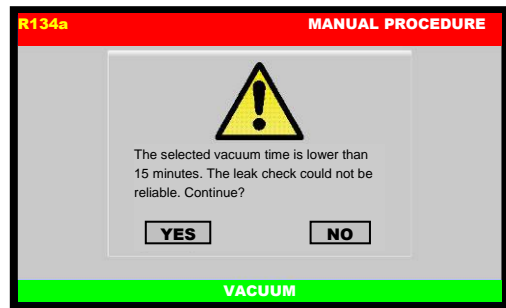

Press YES to continue, or press NO to go back.

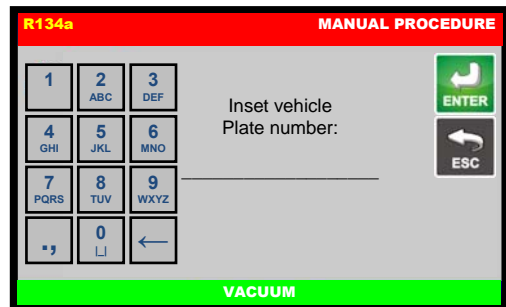

Type the plate of the car, press ENTER to confirm. ESC to return back.

NOTE: the numerical keys include an alphabet that is used similar to text messaging; for example: press "2" once to display "2", twice to display "A", three times for "B", four times for "C", five times for "a", six times for "b", seven times for "c", eight times for "2" again.

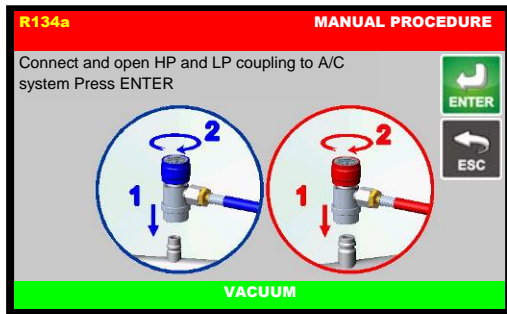

Connect and open the coupling connected to the A/C system, then press ENTER to start the vacuum phase. Press ESC to return back.

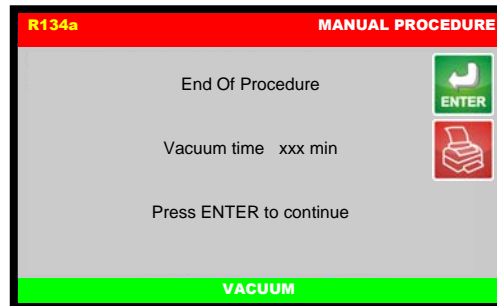

Procedure is now successfully completed.

Press PRINTER to print the receipt of the procedure. Press ENTER to exit.

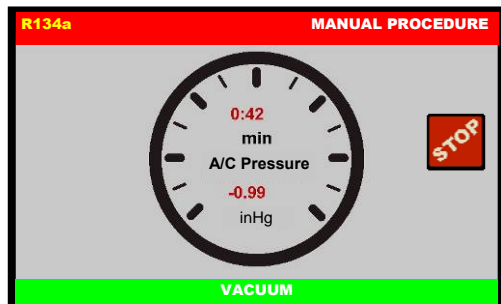

When time of check is reached, the machine will test for leaks in the A/C system:

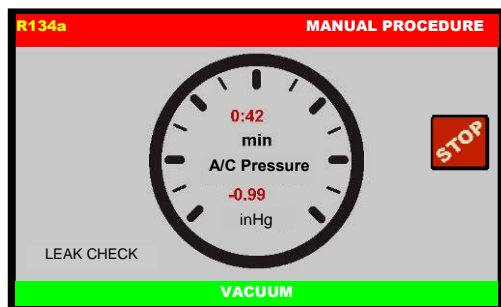

(WARNING! If vacuum time is lower than 15 minutes this test is not reliable). If leaks are found, the machine will stop automatically and display the A/C SYSTEM LEAKS alarm.

Detection of micro-leaks is not guaranteed.

At the end of the preset vacuum time, the machine will sound an alarm and the following screen will be displayed:

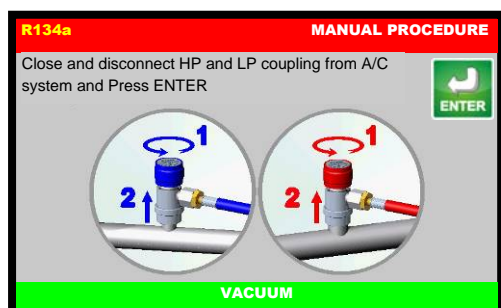

Close and disconnect HP and LP coupling from A/C system, then press ENTER, the following screen will be displayed:

FLUSHING HOSES

This operation makes the machine suitable for a service on vehicles equipped with electrically driven compressors (hybrid vehicles).

From the MANUAL PROCEDURE, select FLUSHING HOSES, the following screen will be displayed:

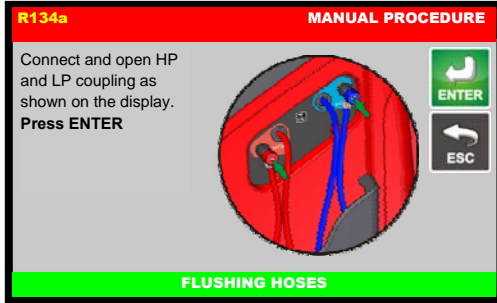

Connect and open the HP and LP couplers to the respective fitting on the machine, then press ENTER to continue:

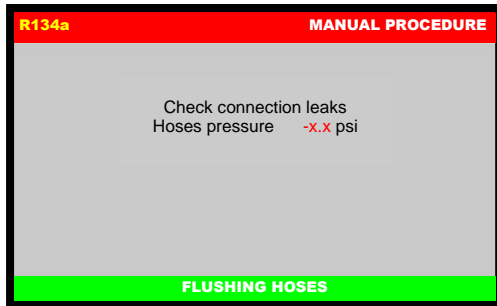

After checking connection leaks, the following screen will be displayed:

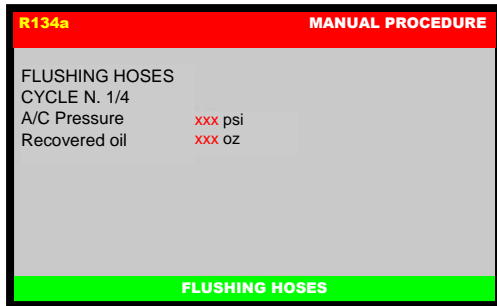

Flushing hoses lasts few minutes, then the machine will sound and alarm and the following screen will be displayed:

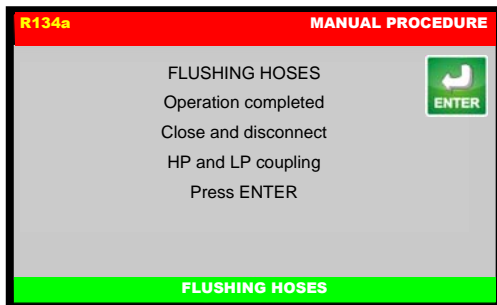

Disconnect coupling, then press ENTER to return to the MAIN MENU; FLUSHING HOSES is now successfully completed.

CHARGE

From the MANUAL PROCEDURE, select CHARGE, the following screen will be displayed:

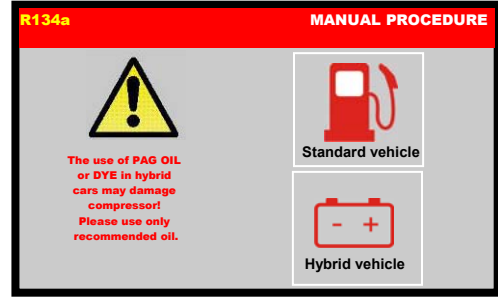

If HYBRID VEHICLE is selected the machine will perform FLUSHING HOSES (Refer to Manual Procedure section, pg 24, FLUSHING HOSES), then the following screen will be displayed:

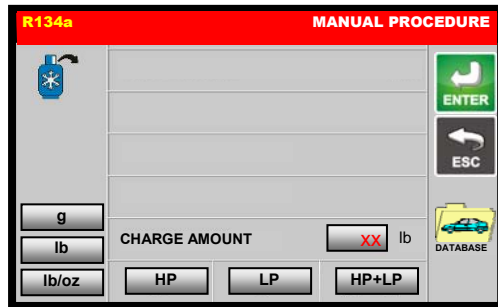

NOTE: press g, lb, or lb/oz to change the weight measurement units.

EDIT CHARGE DATA

NOTE: For most systems the quantity of fluid to be refilled is indicated on a plate that is in the vehicle's engine compartment. If this quantity is not known, look for it in the relevant manuals.

Select CHARGE value box, then use the keys 0 to 9 to type the of refrigerant to be charged into the A/C system.

NOTE: If DATABASE is installed, it can be used to insert the value of refrigerant into the CHARGE field.

NOTE: If charge amount is lower than 4 oz (100 g) the following popup warning will be displayed:

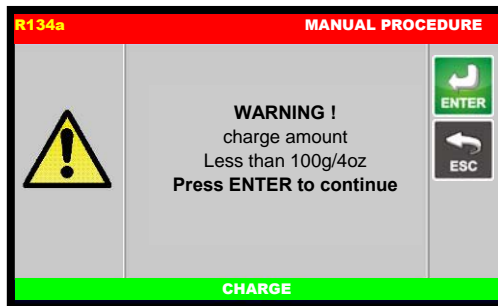

Charge amount lower than 4 oz (100 g) is not allowed, press ENTER then re-enter a higher CHARGE AMOUNT value.

EDIT CHARGE MODE

Select the connection mode:

- HP+LP fill the refrigerant from both HP and LP service ports.
- HP to fill the refrigerant only from the HP service port.
- LP to fill the refrigerant only from the LP service port.

START PROCEDURE

After all CHARGE data is selected, press ENTER to continue, the following screen will be displayed:

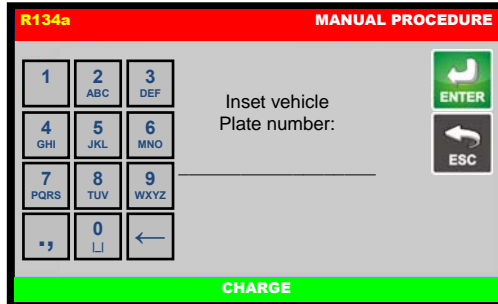

Type the plate of the car, press ENTER to confirm. ESC to return back.

NOTE: the numerical keys include an alphabet that is used similar to text messaging; for example: press "2" once to display "2", twice to display "A", three times for "B", four times for "C", five times for "a", six times for "b", seven times for "c", eight times for "2" again.

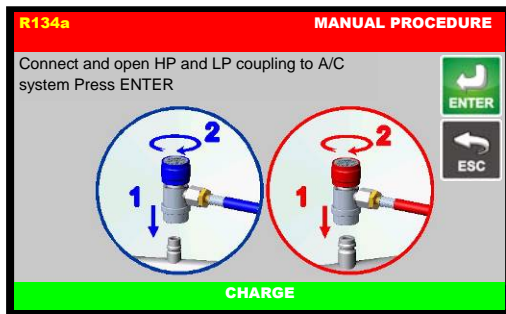

Connect and open the coupling (HP, LP, or HP/LP, depend of the previous choice) connected to the A/C system, then press ENTER. Press ESC to return back.

The machine will start the charge with the preset quantity of refrigerant.

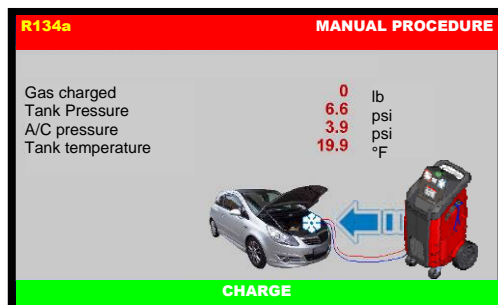

Then the following screen will be displayed:

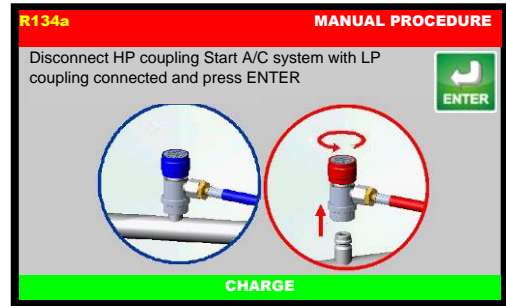

Disconnect HP coupling. Start A/C system with LP coupling connected, press ENTER.

The A/C system will recover the refrigerant into the service hoses, then the following screen will be displayed:

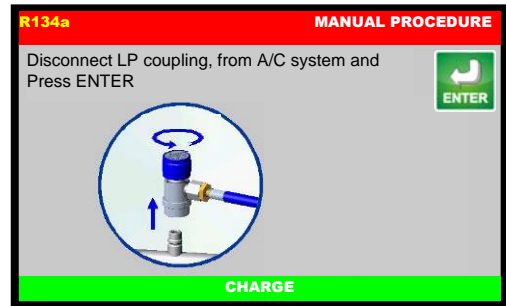

Disconnect LP coupling, then press ENTER to continue:

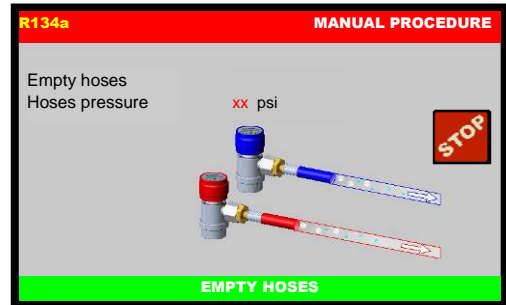

The machine will recover the residual refrigerant into the service hoses, then the following screen will be displayed:

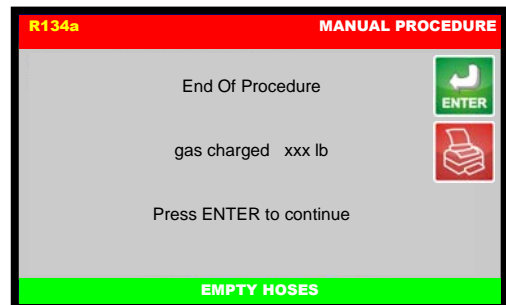

Procedure is now successfully completed.

Press PRINTER to print the receipt of the procedure. Press ENTER to exit.

SERVICES

The machine keeps track of the operations done on refrigerant fluid: recovery, system refilling, inner bottle filling. For any operation, a record is made with date, time, type of operation, quantities involved, plate number, inner bottle refrigerant fluid availability. From the MAIN MENU:

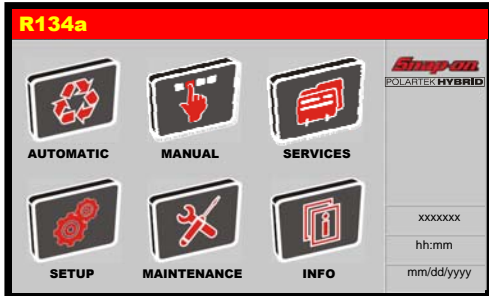

Select the MANUAL PROCEDURE, the following screen will be displayed:

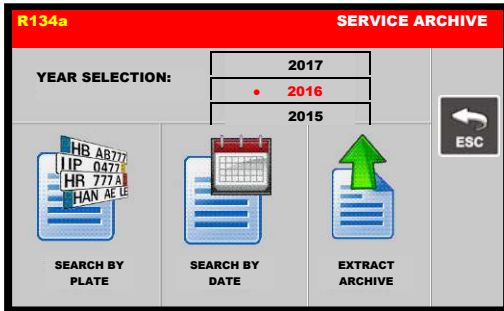

SEARCH BY PLATE

Selecting SEARCH BY PLATE, the following screen will be displayed:

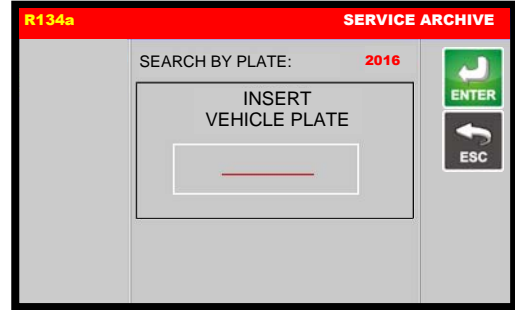

Use the keypad to insert plate number to search, then press ENTER:

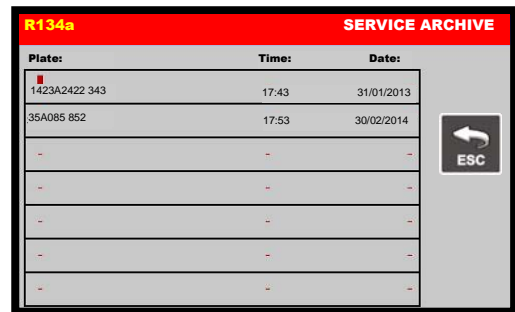

A list will be displayed. Select service for detailed info:

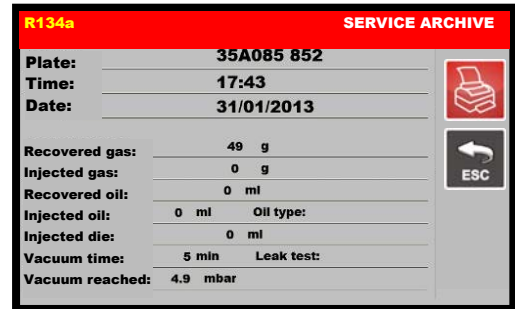

Press PRINTER to print the report of the service, or press ESC to return to previous menu.

SEARCH BY DATE

Selecting SEARCH BY DATE, the following screen will be displayed:

R134a SERVICE ARCHIVE

SEARCH BY DATE: 2016

DAY 01

MONTH 01

ENTER

ESC

Insert date to search, then press ENTER:

R134a SERVICE ARCHIVE

Plate:	Time:	Date:
1423A2422 343	17:43	31/01/2013
35A085 852	17:53	30/02/2014
-	-	-
-	-	-
-	-	-
-	-	-
-	-	-

ESC

A list will be displayed. Select service for detailed info:

R134a SERVICE ARCHIVE

Plate: 35A085 852

Time: 17:43

Date: 31/01/2013

Recovered gas: 49 g

Injected gas: 0 g

Recovered oil: 0 ml

Injected oil: 0 ml Oil type:

Injected die: 0 ml

Vacuum time: 5 min Leak test:

Vacuum reached: 4.9 mbar

Printer icon

ESC

Press PRINTER logo to print the report of the service, or press ESC to return to previous menu.

EXTRACT ARCHIVE

Selecting EXTRACT ARCHIVE, the following screen will be displayed:

R134a SERVICE ARCHIVE

Please insert USB key and press ENTER

ENTER

ESC

Insert the storage device in the USB port and press ENTER, to save to copy a .CSV file with all the operations into the USB storage device.

The following screen will be displayed for few seconds:

R134a SERVICE ARCHIVE

EXTRACT ARCHIVE

Extraction complete

Extraction is now completed. The machine will return to the previous menu.

MAINTENANCE

From the MAIN MENU:



Select the MAINTENANCE, the following screen will be displayed:

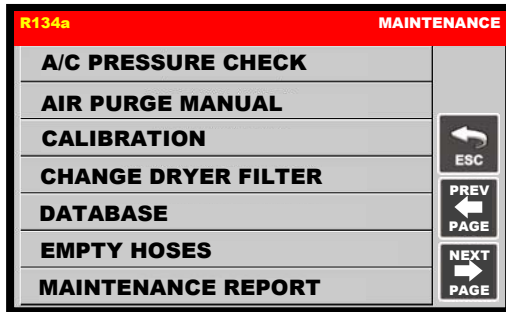

A/C PRESSURES CHECK

From MAINTENANCE select A/C PRESSURES CHECK, the following screen will be displayed:

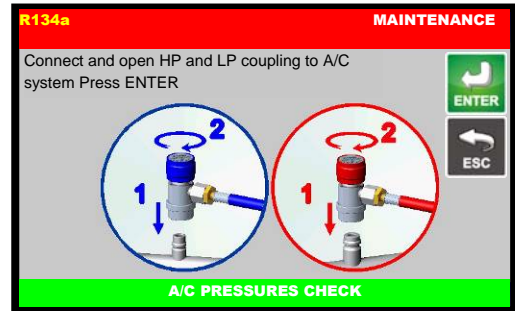

Connect and open the coupling connected to the A/C system, then press ENTER. Press ESC to return back; the following screen is displayed:

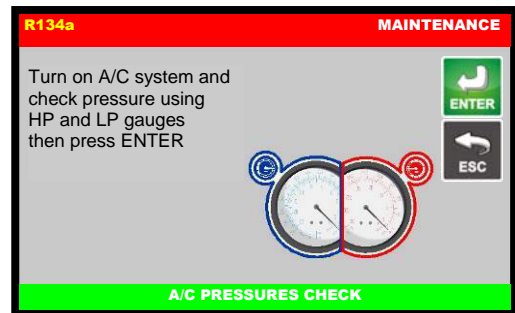

Turn on A/C system and check pressure using HP and LP manometers, then press ENTER:

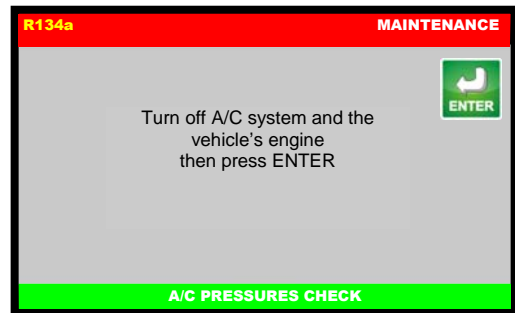

Turn off A/C system and the vehicle's engine, then press ENTER:

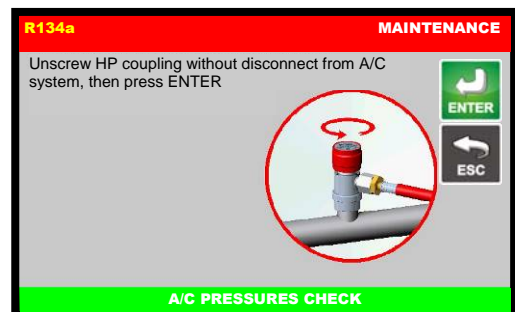

Unscrew HP coupling without disconnect it from A/C system, then press ENTER:

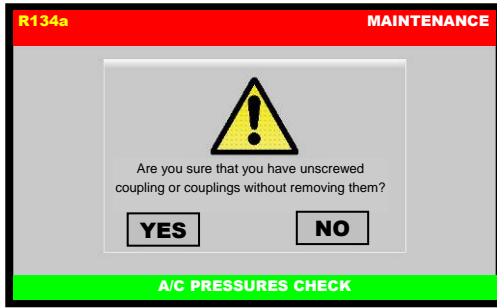

A pop-up message is displayed asking confirmation, press YES to continue:

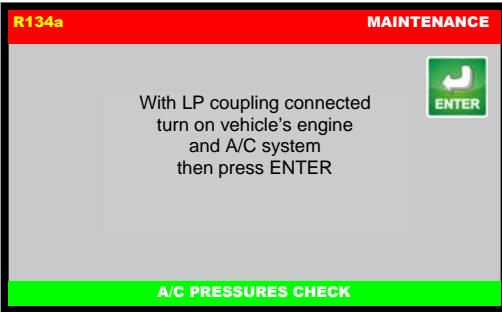

With LP coupling connected turn on the vehicle's engine and A/C system, then press ENTER:

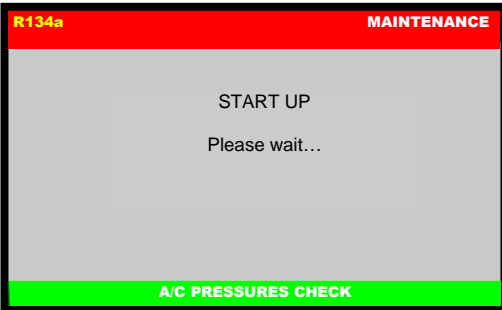

The vehicle's A/C system will recover the refrigerant from the service hoses, then:

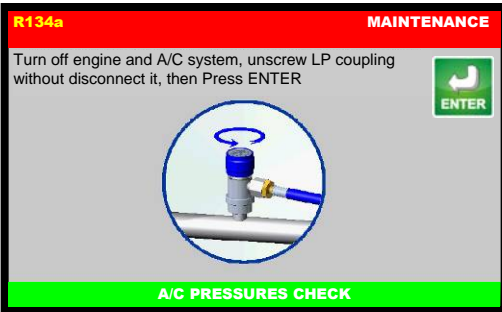

Turn off engine and A/C system, unscrew LP coupling without disconnect it, then press ENTER:

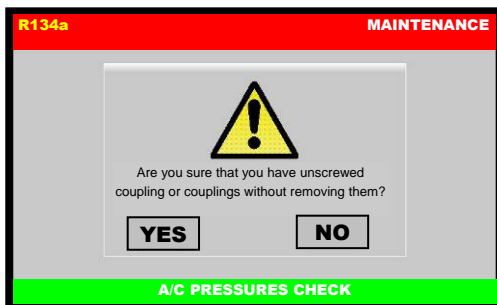

A pop-up message is displayed asking confirmation, press YES to continue:

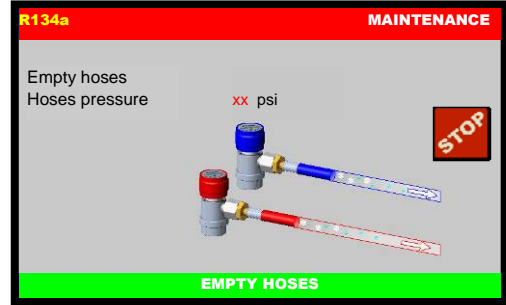

The machine will recover the residual refrigerant into the service hoses, then the following screen will be displayed:

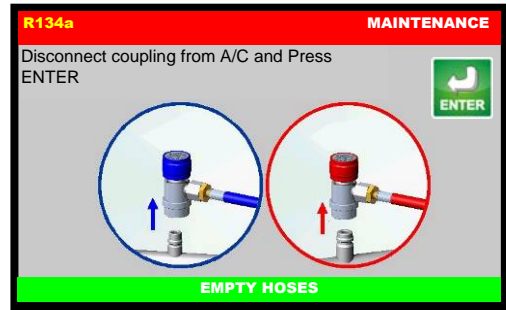

Disconnect coupling from A/C system, then press ENTER:

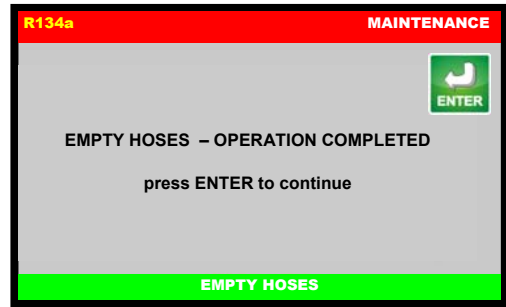

Press ENTER to return to the MAINTENANCE MENU; A/C PRESSURES CHECK is now successfully completed.

AIR PURGE MANUAL

From MAINTENANCE, select AIR PURGE MANUAL, the following screen will be displayed:

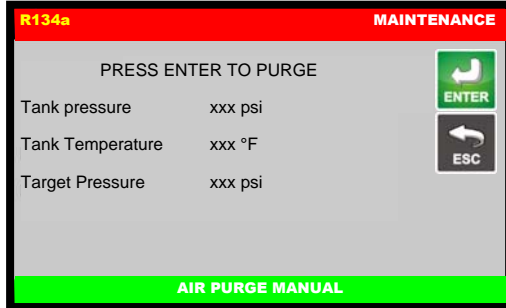

If "PRESS ENTER TO PURGE" is displayed, there is air in the tank. In this case, press ENTER: the machine will begin discharging the air. Press ESC to pause the Air Purging process.

NOTE: If there isn't air into the tank, the following message is displayed: AIR PURGE NOT NECESSARY.

Press ESC to terminate the Air Purging process, and return to the MAINTENANCE menu.

CALIBRATION

For assistance, call the Snap-on
toll-free
Technical Support Line
800-225-5786
in the continental U.S. or Canada.

CHANGE DRYER FILTER

Replace the filter whenever the machine gives the service alarm signals the presence of humidity in the circuit.

Before performing any operation, check that the replacement filter is the same type as these installed on the machine.

Then proceed as described below:

Wear protective gloves and glasses.

Connect the machine to the electrical supply and it turn on.

Note the release code on the new filters.

IMPORTANT: Filter replacement must be performed as quickly as possible in order to avoid possible contamination by moisture in the ambient air.

NOTE: If possible, check the seal on the couplings of the new filter, using an electronic leak tester.

From MAINTENANCE, select CHANGE DRYER FILTER, the following warning message is visualized:

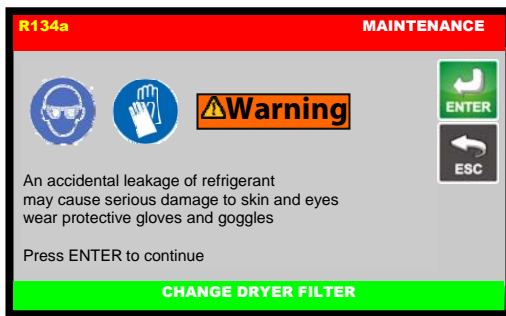

An accidental leakage of refrigerant may cause serious damage to skin and eyes. Wear protective gloves and goggles. Press ENTER to continue:

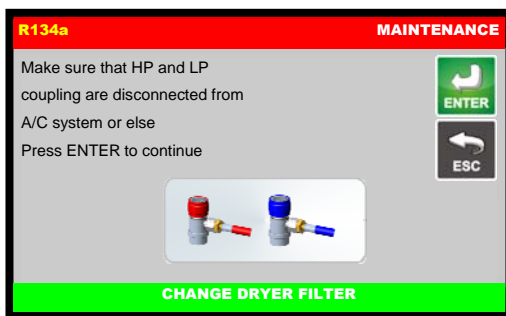

Make sure that HP and LP coupling are disconnected from A/C system or else and press ENTER. Machine will check presence of refrigerant:

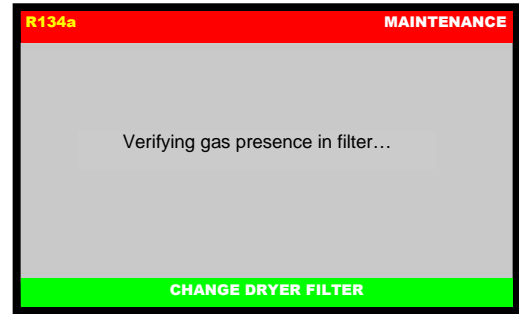

And if necessary will recover it

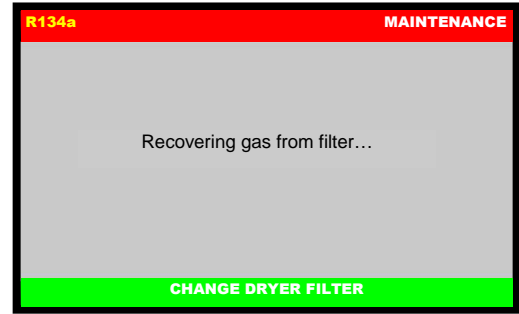

Then the following screen is displayed:

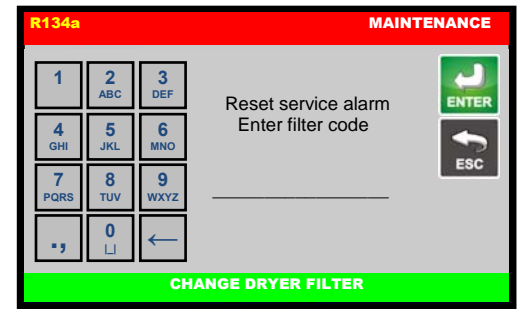

Type the filter code and press ENTER to delete the alarm. If the filter code is not available, call the Service Center:

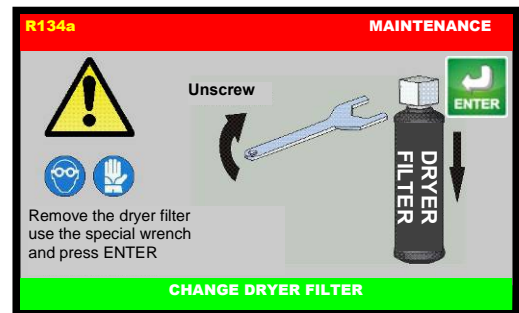

Remove the dryer filter, use the special wrench (ref Fig. 18)

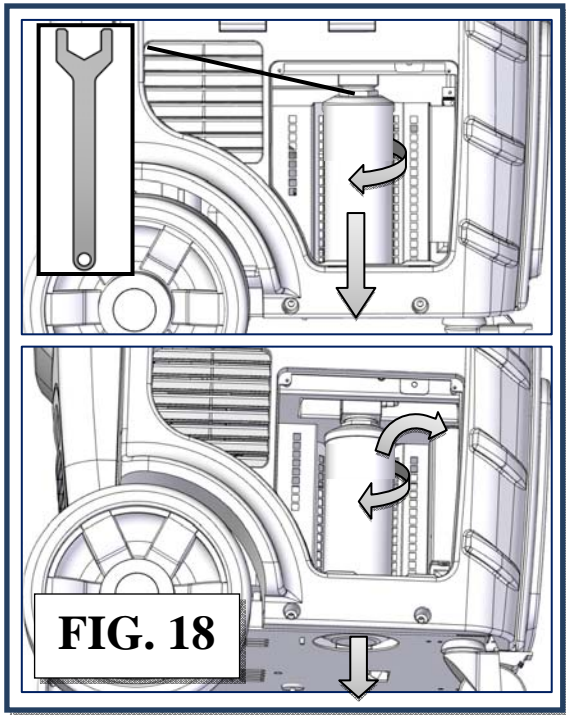

Press ENTER to continue:

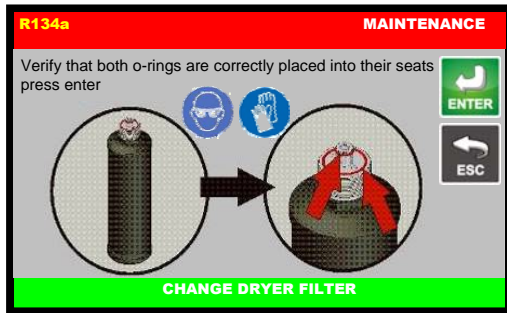

Take the new filter, wet with clean POE oil both o-rings, and verify that they are correctly placed into their slots, press ENTER:

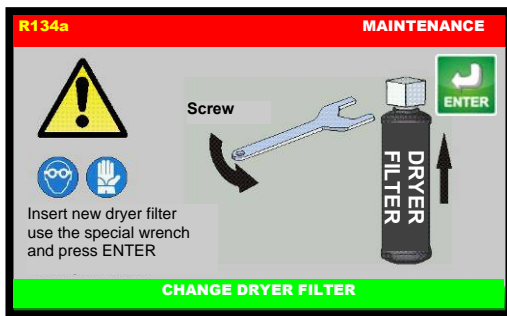

Insert the new dryer filter, use the special wrench (ref Fig. 19),

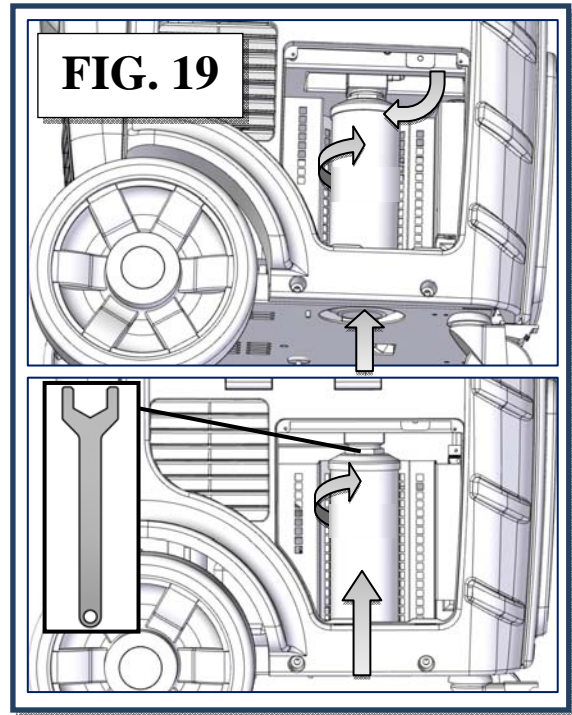

And press ENTER:

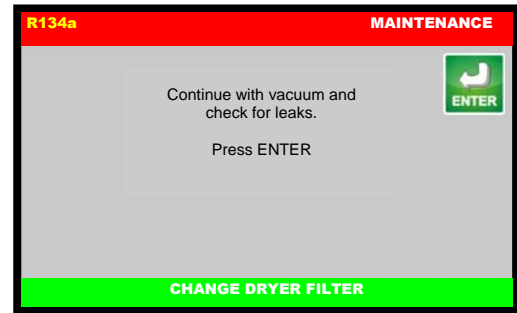

Press ENTER to continue with vacuum check:

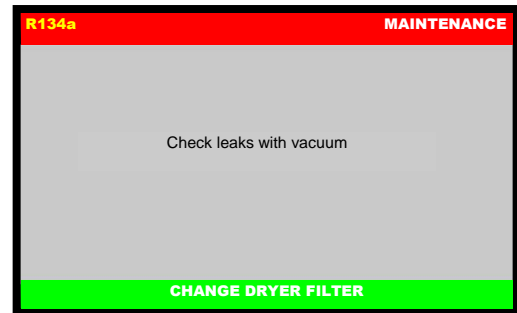

If leaks are detected the following screen will be displayed:

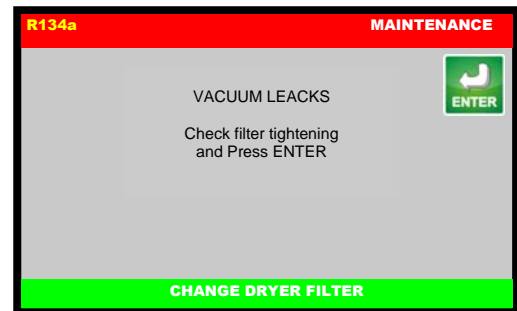

Check filter tightening and press ENTER to restart the vacuum check.

After few minutes, if no leaks are detected the following screen will be displayed:

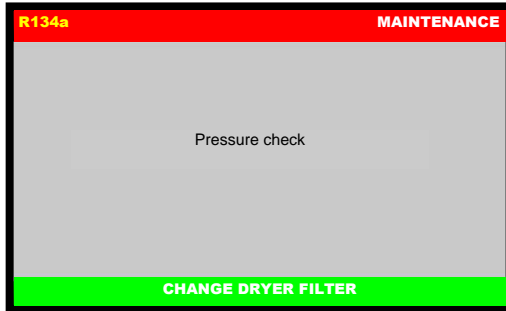

If leaks are detected the following screen will be displayed:

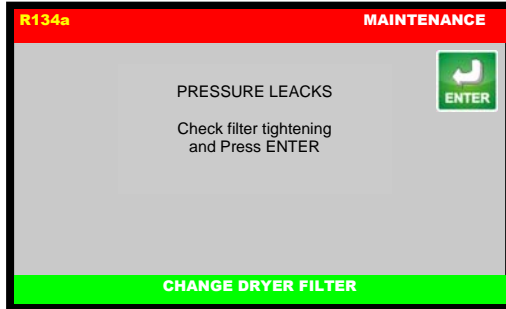

Check filter tightening and press ENTER to restart the pressure check.

If no leaks are detected the following screen will be displayed:

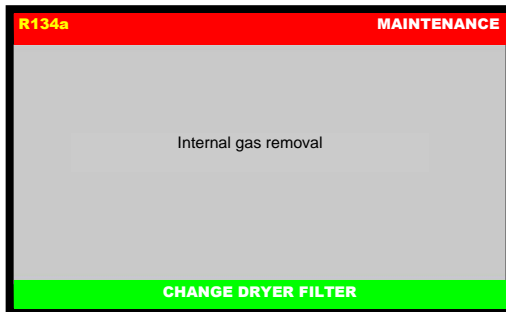

Then After few minutes:

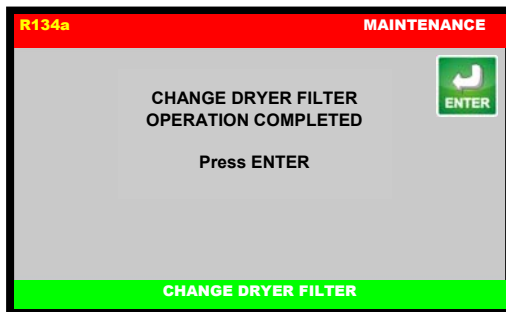

Press ENTER to return to the MAINTENANCE MENU; DRYER FILTER CHANGE is now successfully completed.

DATABASE

From MAINTENANCE, select DATABASE.

A list of brand of vehicle will be displayed.

Select the brand of vehicle, (use the arrow keys to change page if necessary), then select the model of vehicle.

All the information about this model is displayed:

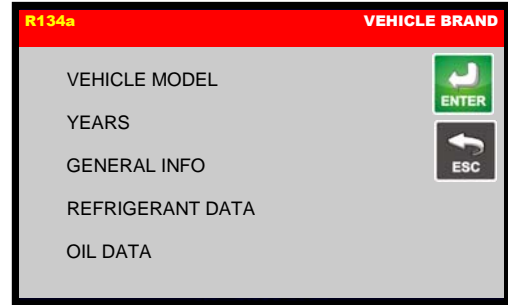

Press ENTER to exit, or ESC to return back to previous screen.

EMPTY HOSES

From MAINTENANCE, select EMPTY HOSES, the following screen will be displayed:

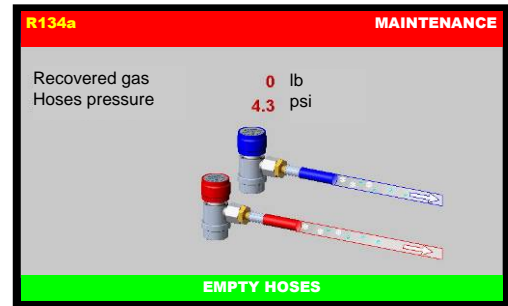

The machine will recover all the refrigerant into the service hoses; then the machine will sound an alarm and the following screen will be displayed:

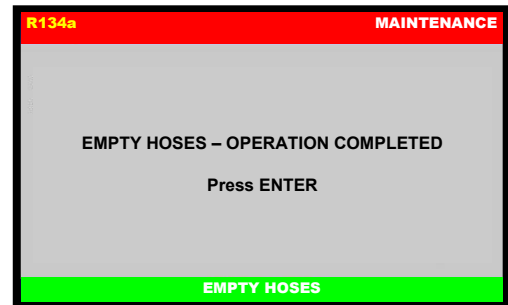

Press ENTER to return to the MAINTENANCE MENU; EMPTY HOSES is now successfully completed.

MAINTENANCE REPORT

From MAINTENANCE, select MAINTENANCE REPORT, the following screen will be displayed:

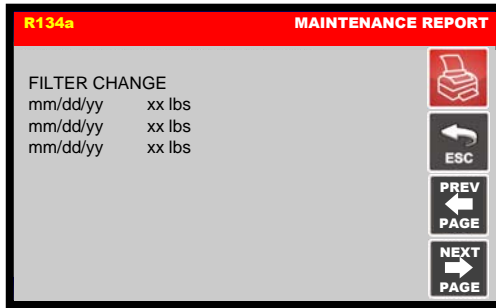

Press PRINTER to print a maintenance report:

- Serial number.
- Total amount of recovered refrigerant.
- Total running time of the vacuum pump.
- Filter change detail

SERVICES ARCHIVE

Refer to SERVICES chapter.

TANK CELL CHECK

From MAINTENANCE, select TANK CELL CHECK, the following screen will be displayed:

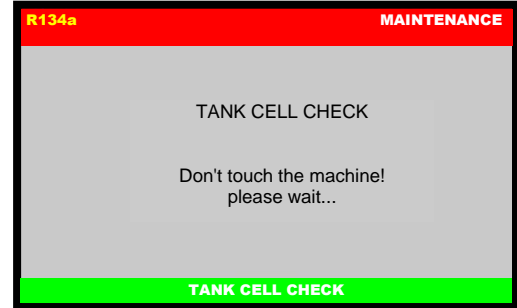

Wait few seconds, paying attention not to touch the machine, then the following screen will be displayed:

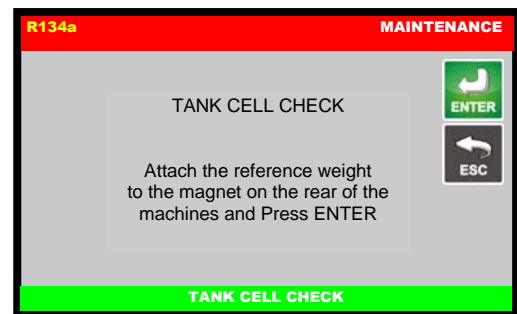

Attach the reference weight to the magnet on the rear of the machines and press ENTER. The following screen will be displayed:

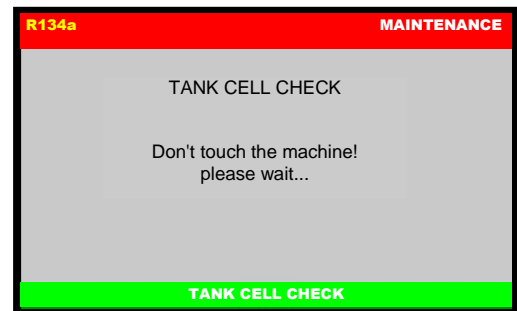

Wait few seconds, then if the tank cell is correctly calibrated the following screen will be displayed:

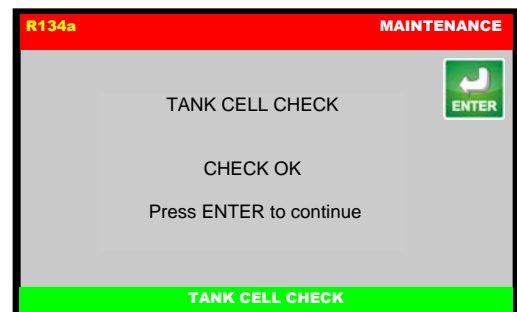

Press ENTER to return to MAINTENANCE MENU

TANK FILLING

This operation must be performed whenever the available refrigerant fluid in the tank is less than 6.6 lb (3 kg) and must in any case be performed when the "empty tank" alarm is displayed.

From MAINTENANCE, select TANK FILLING, the following screen will be displayed:

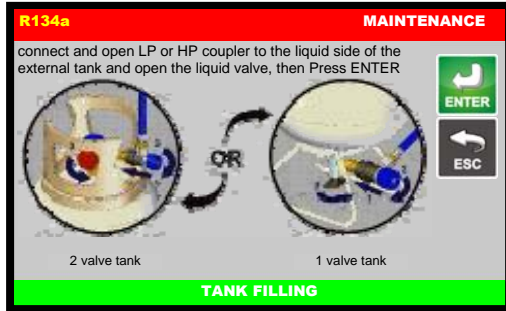

Procure a tank of R134a refrigerant, connect and open LP coupler to the liquid side of the external tank and open the liquid valve, then press ENTER.

The following screen will be displayed:

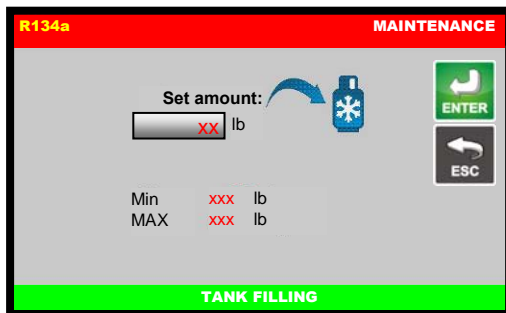

Select set amount, the following screen will be displayed:

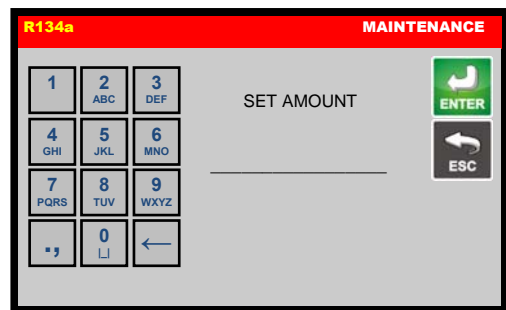

Use the keypad to insert the amount of refrigerant, then press ENTER to continue. The following screen will be displayed:

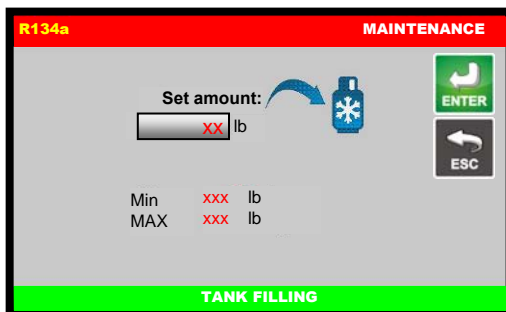

Press ENTER to start The TANK FILLING:

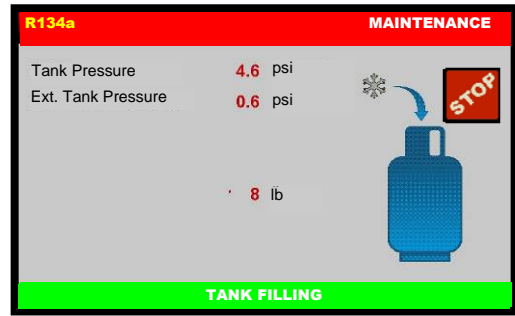

The machine will now fill the machine tank with the preset quantity ~ 1.1 lb (500 g). When the quantity minus 1.1 lb (500 g) is reached, the machine will stop and display:

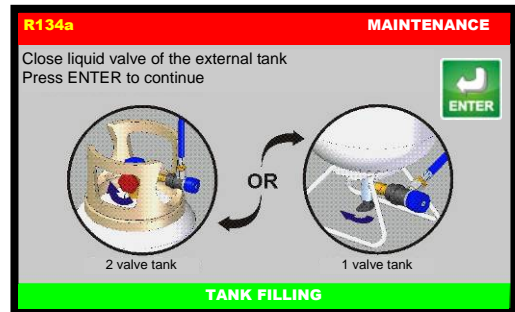

Close the liquid valve of the external tank and press ENTER. The machine will recover the residual refrigerant from the hoses, then will display the following screen:

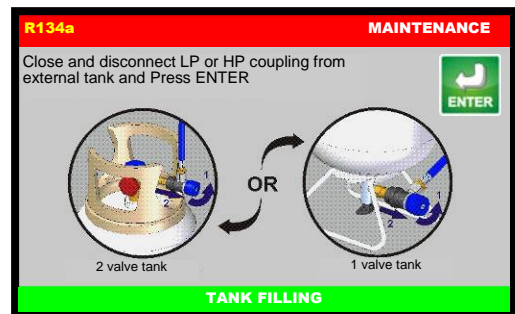

Close and disconnect LP coupling from external tank and press ENTER.

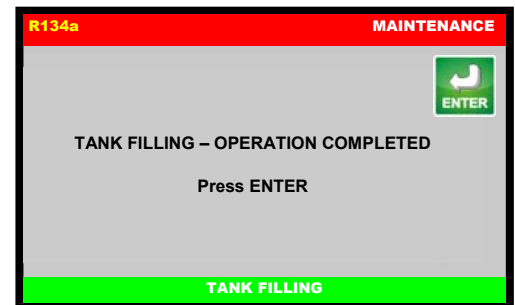

Tank filling procedure successfully completed. Switch the machine off.

NOTE: The refrigerant really filled into the internal tank can vary by ± 1.1 lb (500 g).

NOTE: If the external tank is not supplied with a liquid side coupling, overturn it to recover liquid refrigerant.

VACUUM PUMP OIL CHANGE

From MAINTENANCE, select VACUUM PUMP OIL CHANGE, the following screen will be displayed:

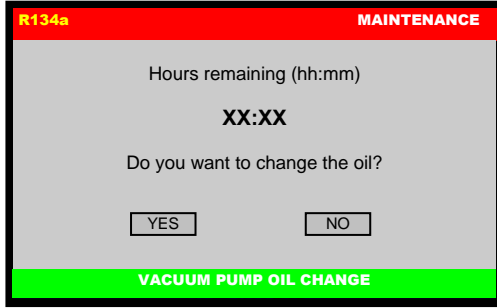

Press NO to exit or press YES to begin the VACUUM PUMP OIL CHANGE, the following screen will be displayed:

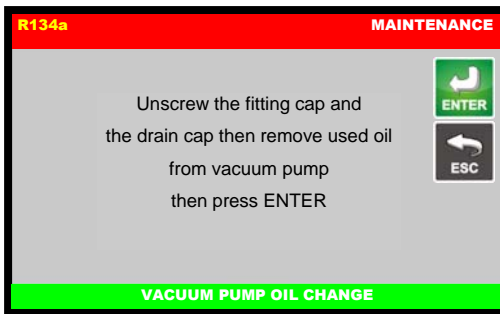

Unscrew the fitting cap and drain the drain cap then remove used oil from vacuum pump then press ENTER, the following screen will be displayed:

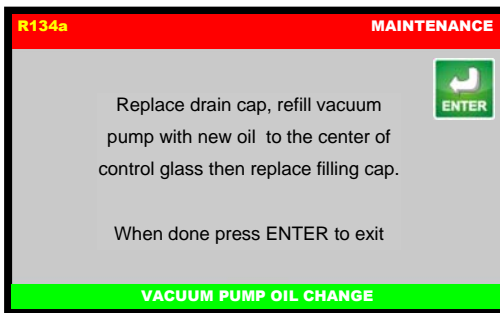

Replace drain cap, refill vacuum pump with new oil to the center of control glass then replace filling cap.

When done press ENTER to exit.

VACUUM PUMP

Perform the operations listed below on a routine basis in order to ensure good operation of the vacuum pump.

When replacing the pump oil, use only the oil recommended by the manufacturer. Contact your retailer for information concerning the correct type of oil.

The vacuum pump oil must be replaced every 15 hours of functioning and in any case every time the refrigerant filters are replaced.

NOTE: Alarm message is visualized, to remove alarm message refer to VACUUM PUMP OIL CHANGE paragraph.

The oil must also be replaced whenever it changes color due to absorption of humidity. Before beginning the oil change procedure, procure a container of at least 17 oz (500 cc) capacity in which to collect the used oil. The pump contains about **14.9 oz (440 cc) of oil**. Use only the oils recommended by the manufacturer (consult your retailer). The use of a non-recommended oil may impair the proper functioning of the pump and void the warranty.

Disconnect the machine from the main supply.

Place a container (ref 4, Fig. 23). under the drain cap (ref 2, Fig. 23).

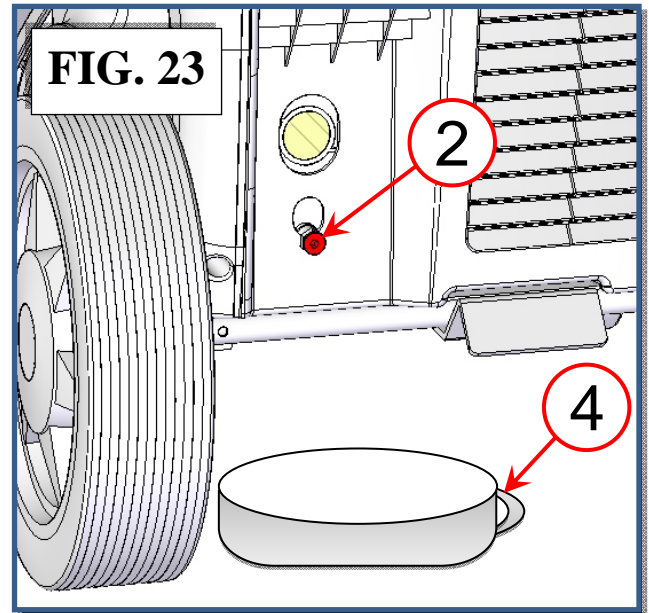

Unscrew the filling cap (ref 1, Fig. 24).

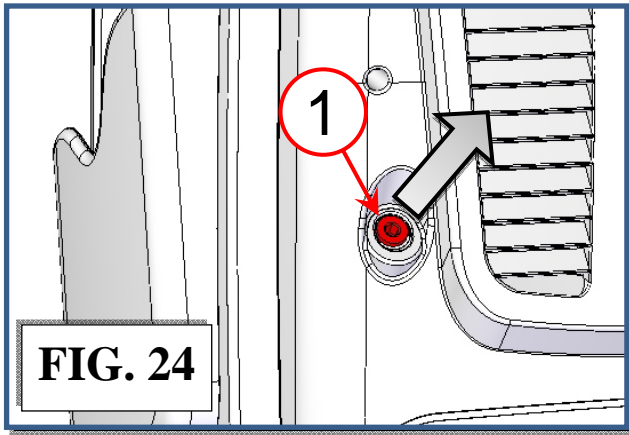

Unscrew the drain cap (ref 2, Fig. 25).

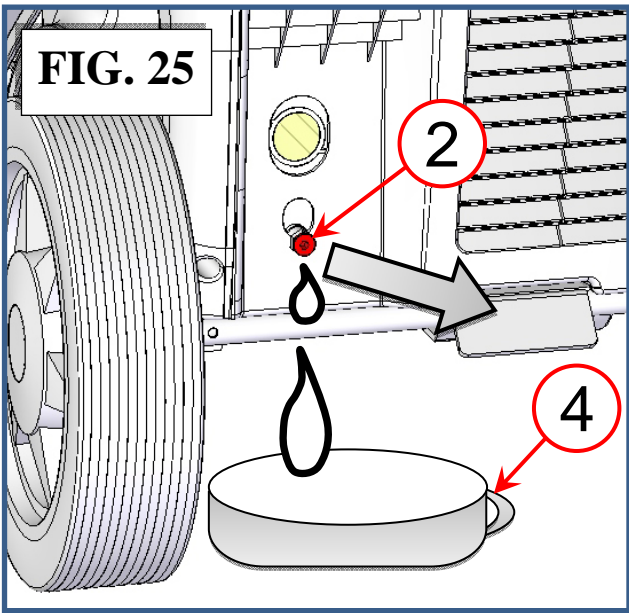

Allow all the oil to run out into a disposal container (ref 4 Fig. 25), with height < 4 in (10 cm).

Close the drain cap (ref 2, Fig. 26).

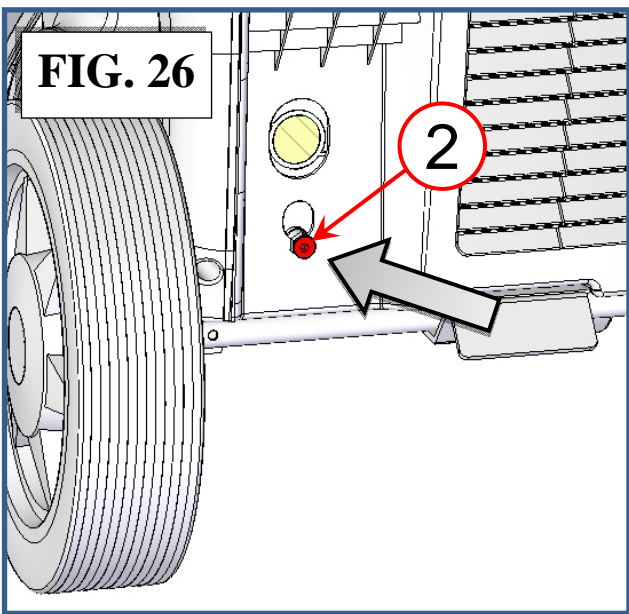

Pour in new oil through the filling hole, using a proper funnel (ref 5, Fig. 27), until the level rises to the midpoint on the indicator (ref 3, Fig. 27).

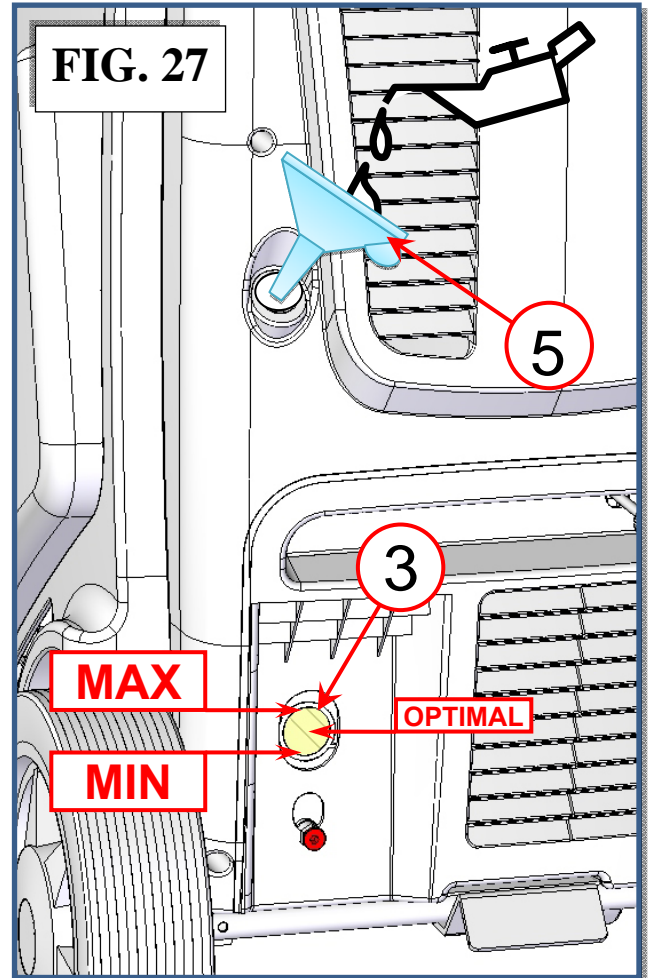

Add oil a little at a time, waiting for the level to rise before each successive addition, until the oil reach the optimal level on the indicator (ref 3, Fig. 27).

Replace the filling cap (ref 1, Fig. 28) and tighten down.

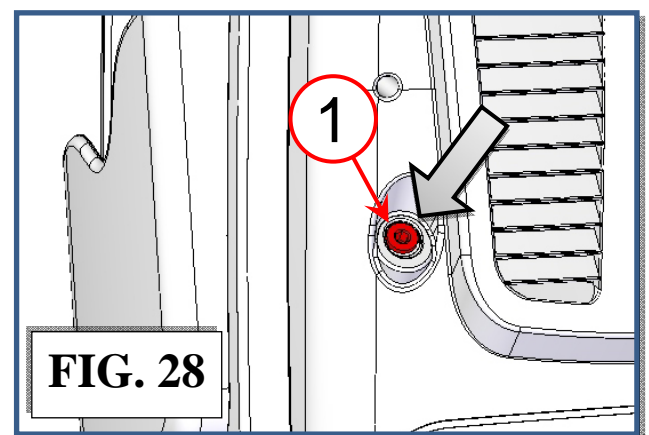

EMPTYING THE USED OIL CONTAINER

Procedure:

Open the upper door on the right side (ref 4, Fig. 37).

Press quick connection button (ref 1, Fig. 37) to disconnect the used oil container.

Lift the used oil container out of its lodging (ref n, Fig. 37) without exerting pressure on the scale.

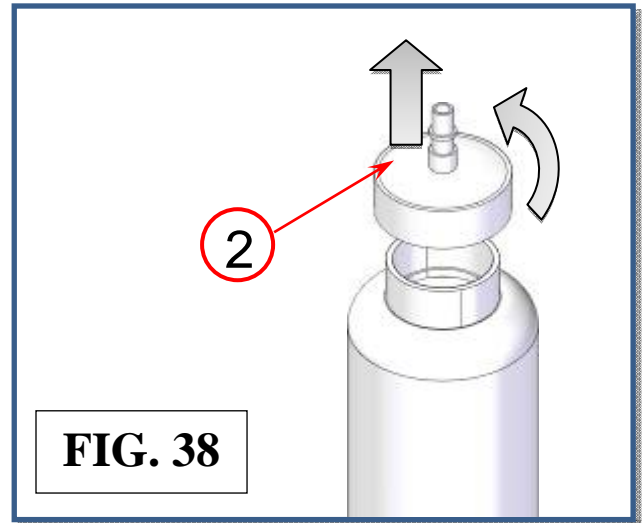
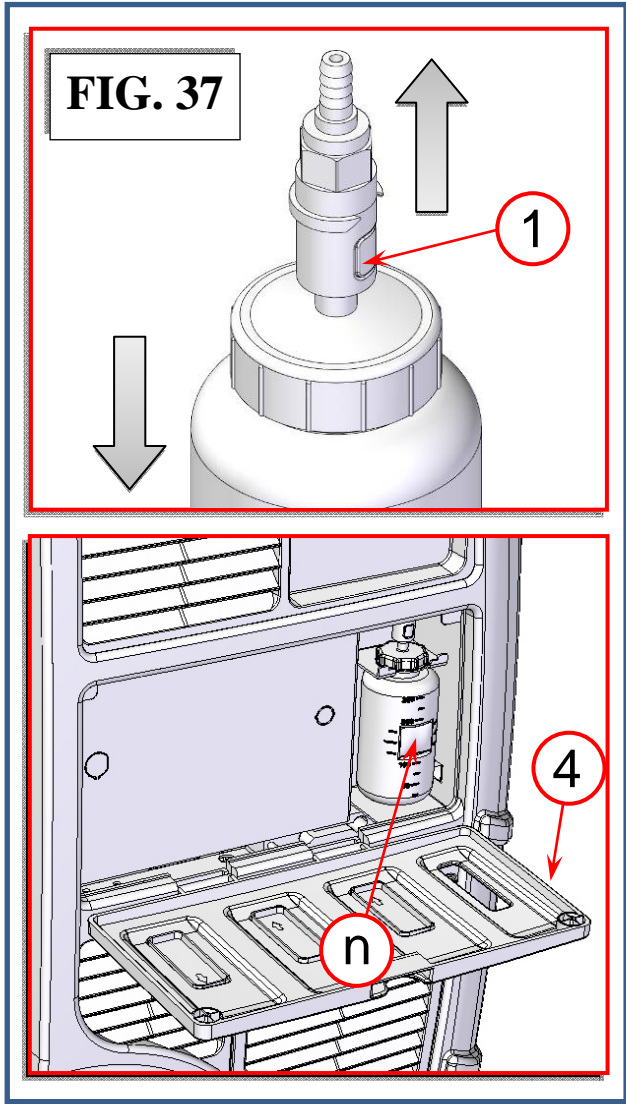

Empty the used oil into a suitable container for used oils (Fig. 39).

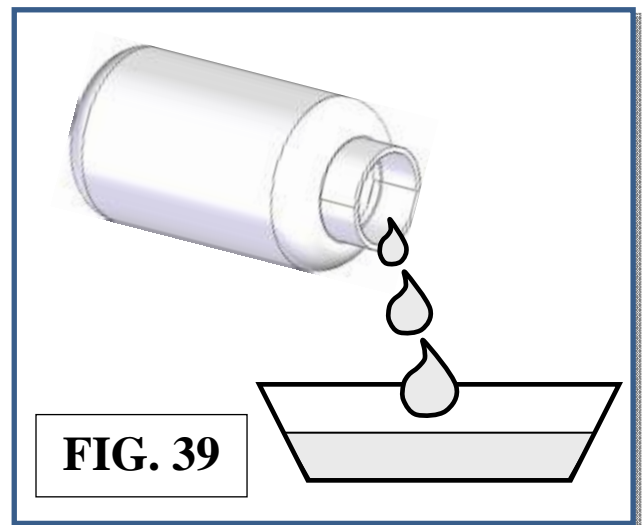

Screw the cap back into the container.

Replace the container and hook it up to the quick connection taking care not to exert pressure on the scale in order not to damage it.

NOTE: In order to avoid damage to the oil scale, never exert pressure on it either from above or from below.

Unscrew the cap (ref 2, Fig. 38) while holding the container.

REPLACING THE PRINTER PAPER

Open the print cover (ref 3, Fig. 40), and replace the paper roll with a new one.

Use only heat-sensitive paper of the type described below.

Paper width: 2.2 in (58 mm).

Maximum paper roll diameter: 1.6 in (40 mm).

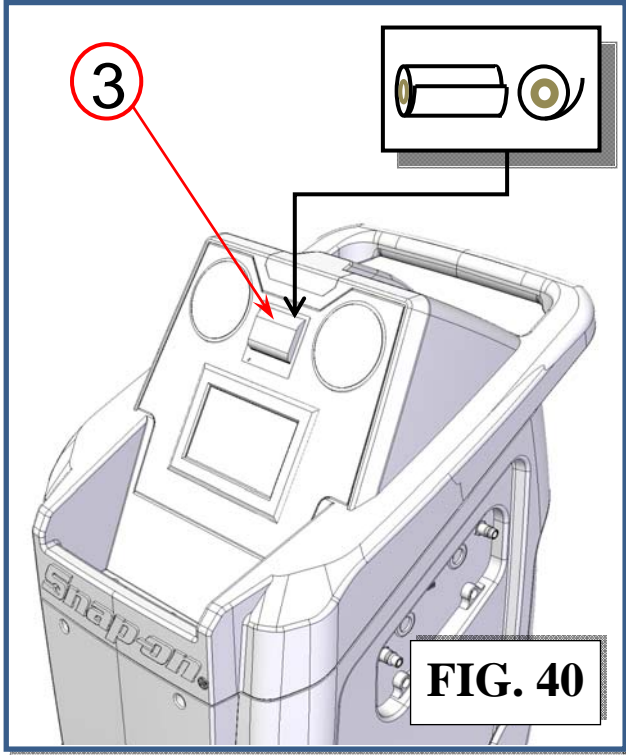

INFO

From the MAIN MENU:

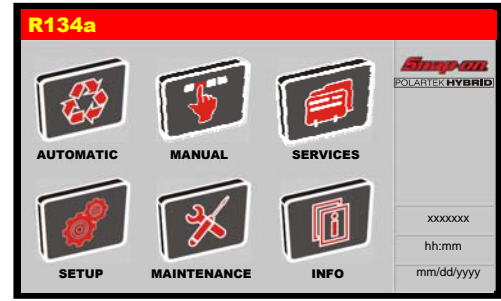

Select the INFO, the following screen will be displayed:

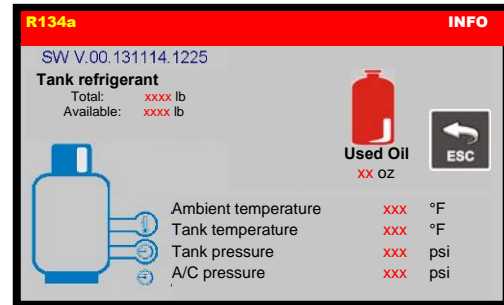

SW V.: Software version.

Tank refrigerant:

- Total: total amount of refrigerant in the storage tank.
- Available: quantity of refrigerant available in the storage tank.

Used: quantity of OIL in the USED OIL container.

Ambient temperature: ambient temperature near the service station.

Tank temperature: refrigerant storage tank temperature.

Tank pressure: refrigerant storage tank pressure.

A/C pressure: pressure in the service hoses.

Press ESC to return to MAIN MENU.

WARRANTY

This product is warranted against any defect in materials and/or construction for a period of 2 (two) years from the date of delivery. The warranty consists of free-of-charge replacement or repair of defective component parts or parts considered defective by the Manufacturer. Reference to the machine serial number must be included in any requests for spare parts. This warranty does not cover defects arising from normal wear, incorrect or improper installation, or phenomena not inherent to normal use and operation of the product.

The manufacturer guarantees the perfect suitability of the materials used for packing, in terms both of composition and mechanical strength/resistance. The guarantee does not cover breakdowns attributable to damage suffered during shipping or warehousing or caused by the use of accessories not meeting manufacturer's specifications, or to tampering with or repair of the product by unauthorized personnel. It is of utmost importance that the crates containing the machine be carefully inspected, upon delivery, in the presence of the shipping agent. We recommend performing inspection with extreme care, since damages to the crates due to shocks or dropping are not always immediately visible thanks to the shock-absorbing capacity of today's composite packing materials. The apparent integrity of the packing materials does not exclude possible damage to the goods, despite the due care taken by the manufacturer in packing them.

NOTE: Regarding the above, the Manufacturer reminds the Customer that according to international and national laws and regulations in force the goods are shipped at the sole risk of the latter and, unless otherwise specified in the confirmation of order phase, the goods are shipped uninsured. The Manufacturer therefore declines any and all responsibility in merit of CLAIMS for damages due to shipping, loading and unloading, and unpacking.

The product for which repair under guarantee is requested must be shipped to the manufacturer under the customer's exclusive responsibility and at the customer's exclusive expense and risk. In order to avoid damage during shipping for repairs, the Manufacturer's original packing must always be used.

The manufacturer declines any and all responsibility for damage to vehicles on which recovery/recycling and recharging are performed if said damage is the result of unskillful handling by the operator or of failure to observe the basic safety rules set forth in the instruction manual. This warranty replaces and excludes any other warranty or guarantee that the seller is required to provide under law or contract and defines all the customer's rights in regard of faults and defects and/or scarce quality in the products as purchased.

The warranty will expire automatically at the end of the twenty-four-month period or whenever one of the following occurs: failure to perform maintenance; use of improper maintenance procedures; use of unsuitable lubricants and/or tracer fluids; inept or improper use; repairs performed by unauthorized personnel and/or with non-original spare parts; damage caused by shocks, fires, or other accidental events.

Made in USA
Snap-on is a trademark of Snap-on Incorporated
©2016 Snap-on Incorporated
Printed in USA
Snap-on, 2801 80th St., Kenosha, WI 53143
www.snapon.com
