



EEAC333B POLARTEK YF

R1234YF Refrigerant Recovery/ Recycle /
Recharge Service Vehicle A/C System



PARTS MANUAL

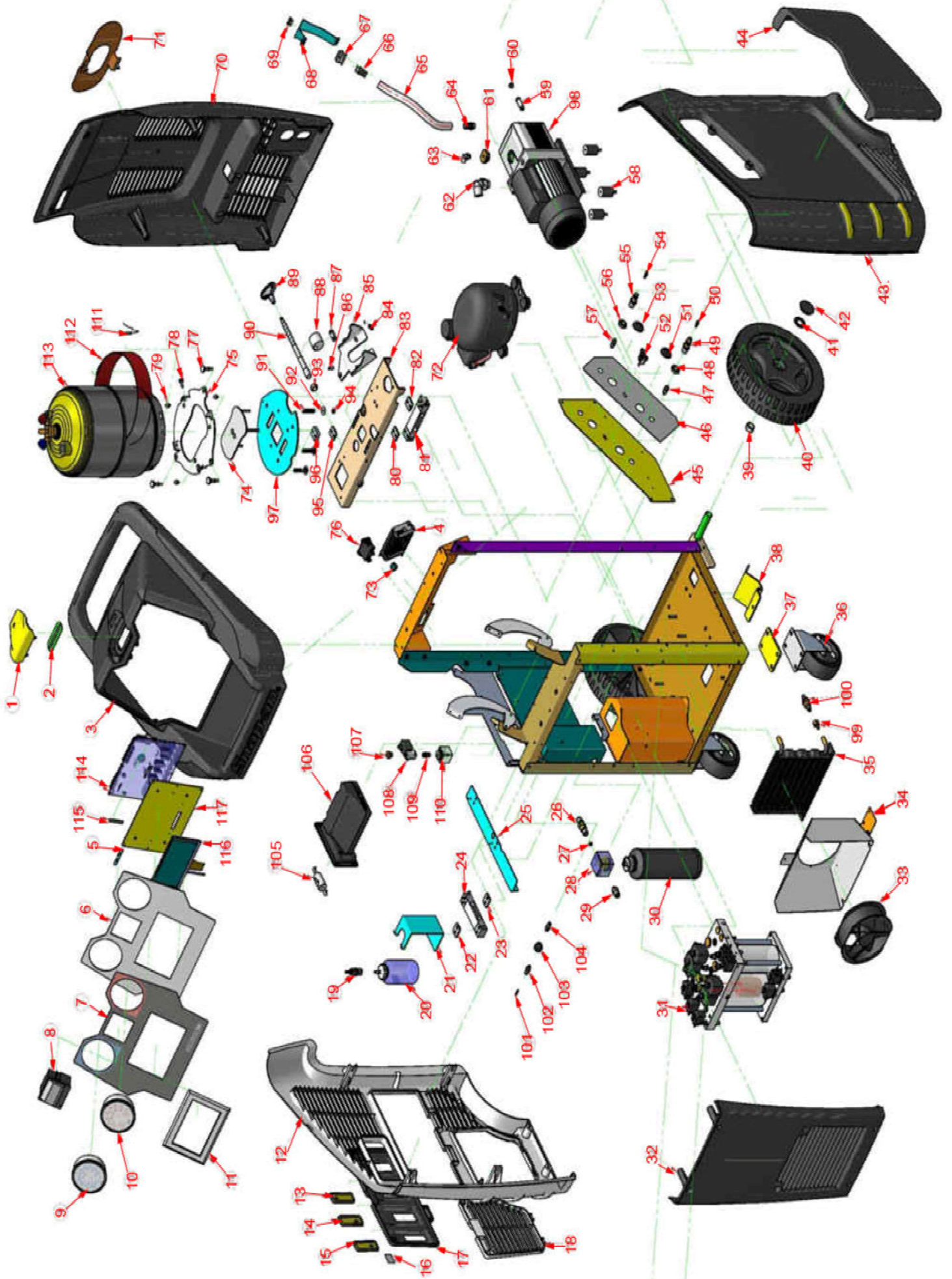

REF#	PART NUMBER	DESCRIPTION
1	EEAC331-12	TRANSPARENT LED COVER
2	EEAC331-18	LED LIGHT MOTHERBOARD
3	EEAC330-43	UPPER PLASTIC CARTER
4	EEAC330B-12	POWER ADAPTER
5	EEAC330-119	CONTROL PANEL FIXING PLATE
6	EEAC331B-2	CONTROL PANEL (7" DISPLAY) SHEETMETAL
7	EEAC333-2	POLARTEK YF PANEL STICKER
8	GRSTM0007D	PRINTER
9	EEAC331-10	LP 100MM GAUGE
10	EEAC331-9	HP 100MM GAUGE
11	EEAC331B-7	7" DISPLAY FRAME
12	EEAC330-36	RIGHT PLASTIC COVER
13	EEAC330-41	OIL DOOR CAP
14	EEAC330-41	OIL DOOR CAP
15	EEAC330-41	OIL DOOR CAP
16	EEAC330-3	USED OIL GLAZED STICKER
17	EEAC330-39	OIL DOOR
18	EEAC330-40	FILTER DOOR
19	EEAC330-57	USED OIL CONTAINER PLUG - RED
20	EEAC330-27	USED OIL CONTAINER - RED CAP
21	CRP4164-V	USED OIL CONTAINER SUPPORT
22	EEAC330-12	SCALE SPACER 4MM
23	EEAC330-12	SCALE SPACER 4MM
24	EEAC330-10	USED OIL SCALE - 15KG
25	CRP5036	OIL SUPPORT BRACKET
26	EEAC330-83	3/8SAE CHECK VALVE
27	EEAC334-41	1/8GAS FILTER FITTING
28	EEAC330-96	FILTER MANIFOLD
29	EEAC330-97	NIPPLE 1/8GAS-3/8SAE
30	EEAC330-23B	DRYER FILTER
31	EEAC333B-1	MANIFOLD
32	EEAC330-42	FRONT PLASTIC COVER
33	EEAC333-7	FAN FOR CONDENSER
34	CRP5022	FAN AIR DUCT
35	EEAC333-9	CONDENSER (WITHOUT FAN)
36	EEAC330-59	FRONT CASTER WITH BRAKE
37	CRP5024	FRONT CASTER SPACER
38	CRP4198	FOOT BRACKET
39	RAC6020	REAR WHEEL SPACER
40	EEAC330-60	300MM REAR WHEEL

REF#	PART NUMBER	DESCRIPTION
41	EEAC330-61	REAR WHEEL RETAINER
42	EEAC330-67	REAR WHEEL CAP
43	EEAC330-35	LEFT PLASTIC COVER
44	EEAC330-38	PLASTIC POCKET
45	CRP5018	SIDE CONNECTION PLATE
46	EEAC331-4	SIDE CONNECTION STICKER
47	EEAC330-93	NIPPLE 1/8GAS-1/4SAE
48	M16NUT	M16 NUT
49	EEAC333-10	HP QUICK FITTING
50	EEAC332-2	SCHRADER VALVE
51	EEAC330-68	PROTECTION HP HOSE OUTLET
52	EEAC330-21	USB PORT
53	EEAC330-68	PROTECTION LP HOSE OUTLET
54	EEAC332-2	SCHRADER VALVE
55	EEAC333-11	LP QUICK FITTING
56	M16NUT	M16 NUT
57	EEAC330-93	NIPPLE 1/8GAS-1/4SAE
58	EEAC330-49	ANTIVIBRATION RUBBER
59	EEAC330-116	OIL DRAIN EXTENSION
60	EEAC334-49	OIL DRAIN CAP
61	EEAC330-117	FITTING M24 - 1/8GAS
62	EEAC334-42	10MM ELBOW OGIVE FITTING
63	EEAC334-48	6MM ELBOW OGIVE FITTING
64	EEAC334-43	HOSE FITTING 16MM
65	EEAC334-44	OIL PUMP FILLING HOSE
66	EEAC334-45	HOSE FITTING 16MM
67	EEAC334-47	MOUNT ADAPTER FITTING
68	EEAC330-118	OIL PUMP FILLING BRACKET
69	EEAC334-46	OIL PUMP FILLING CAP
70	EEAC330-37	REAR PLASTIC COVER
71	EEAC330-14	CORD WRAP
72	EEAC333B-4	COMPRESSOR
73	EEAC330-18	CABLE GUIDE FOR POWER CABLE
74	CRP5051	DAMPER PLATE
75	CRP5050	TANK PLATE2
76	EEAC330-19	MAIN SWITCH (CIRCUIT BREAKER)
77	EEAC330A-5	TANK PLATE STOP SCREW
78	VIT0069	TANK FIXING BOLT
79	EEAC330A-4	TANK PLATE CENTERING PIN
80	EEAC330-12	SCALE SPACER 4MM

REF#	PART NUMBER	DESCRIPTION
81	EEAC330-124	TANK SCALE - 50KG
82	EEAC330-12	SCALE SPACER 4MM
83	CRP5048	MIDDLE LEVEL FRAME REINFORCEMENT
84	EEAC334-56	COMPRESSION SPRING
85	CRP5052	TANK LOCK LEVER
86	EEAC330A-6	THREADED BALL SPRING PLUNGER
87	RAC5209	CAM PLATE
88	RAC5208	CAM
89	EEAC330A-3	TANK LOCK/UNLOCK HANDLE
90	RAC5206	LOCK LEVER SHAFT
91	EEAC334-56	COMPRESSION SPRING
92	VIT0004	WASHER FOR COMPRESSION SPRING
93	VIT0070	M12 NUT
94	VIT0023	M6 NUT
95	EEAC330-12	SCALE SPACER 4MM
96	EEAC330-100	SCALE SPACER 10MM
97	CRP5049	TANK PLATE1
98	EEAC331-13	VACUUM PUMP
99	RAC5190	WELD FITTING 1/4SAE FEMALE
100	EEAC330-82	1/4SAE CHECK VALVE
101	EEAC330-50	SCHRADER VALVE
102	EEAC334-69	NIPPLE 1/8GAS-1/4SAE FOR VALVE
103	RAC5600	MOUNT ADAPTER FITTING
104	EEAC330-93	NIPPLE 1/8GAS-1/4SAE
105	EEAC333-8	GAS ANALYZER FILTER
106	EEAC333-18	GAS ANALYZER
107	RAC5191	GAS ANALYZER PRESSURE REDUCER
108	VLV1461-N-E	GAS ANALYZER ELECTRONIC VALVE
109	EEAC330-170	NIPPLE 1/8GAS 1/8GAS
110	GRDIS1343	GAS ANALYZER INLET FILTER MANIFOLD
111	EEAC330-66	TANK TEMPERATURE PROBE
112	EEAC330B-2	TANK HEATER
113	EEAC330-11	REFRIGERANT STORAGE TANK
114	EEAC331B-9	MOTHERBOARD
115	EEAC330B-11	WIFI ANTENNA
116	EEAC331B-13 OR EEAC331B-14	7" LCD DISPLAY/ SUPPORT

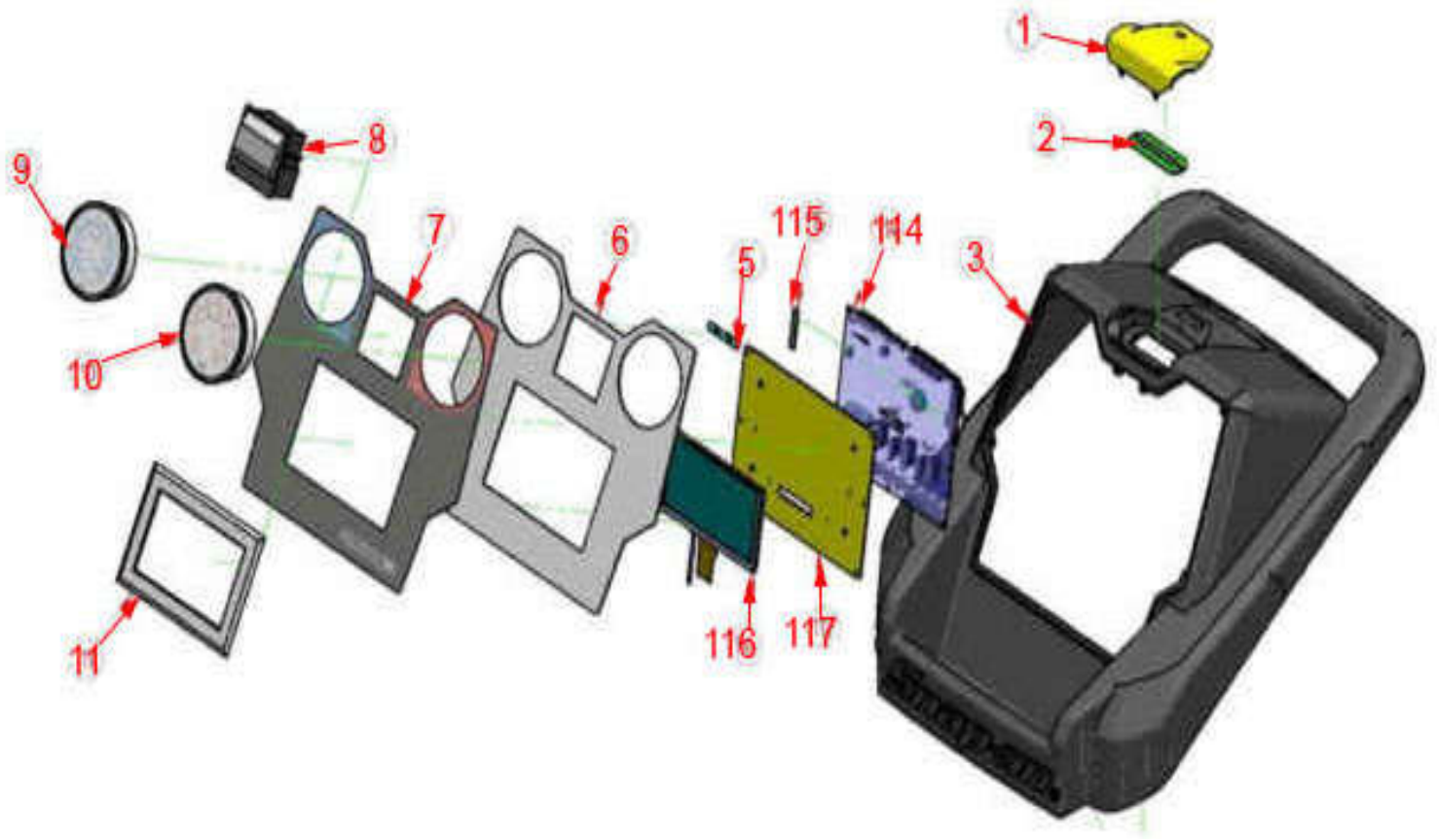

REF#	PART NUMBER	DESCRIPTION
1	EEAC331-12	TRANSPARENT LED COVER
2	EEAC331-18	LED LIGHT MOTHERBOARD
3	EEAC330-43	UPPER PLASTIC CARTER
5	EEAC330-119	CONTROL PANEL FIXING PLATE
6	EEAC331B-2	CONTROL PANEL (7" DISPLAY)
7	EEAC333-2	POLARTEK YF PANEL STICKER
8	EEAC331-19	PRINTER
9	EEAC331-10	LP 100MM GAUGE
10	EEAC331-9	HP 100MM GAUGE
11	EAC331B-7	7" DISPLAY FRAME
114	EEAC331B-9	MOTHERBOARD
115	EEAC330B-11	WIFI ANTENNA
116	EEAC331B-13 OR EEACB-14	7" LCD DISPLAY W/ SUPPORT



REF#	PART NUMBER	DESCRIPTION
4	EEAC330B-12	POWER ADAPTER
12	EEAC330-36	RIGHT PLASTIC COVER
13	EEAC330-41	OIL DOOR CAP
14	EEAC330-41	OIL DOOR CAP
15	EEAC330-41	OIL DOOR CAP
16	EEAC330-3	USED OIL GLAZED STICKER
17	EEAC330-39	OIL DOOR
18	EEAC330-40	FILTER DOOR
19	EEAC330-57	USED OIL CONTAINER PLUG - RED
20	EEAC330-27	USED OIL CONTAINER - RED CAP
21	CRP4164-V	USED OIL CONTAINER SUPPORT
22	EEAC330-12	SCALE SPACER 4MM
23	EEAC330-12	SCALE SPACER 4MM
24	EEAC330-10	USED OIL SCALE - 15KG
25	CRP5036	OIL SUPPORT BRACKET
26	EEAC330-83	3/8SAE CHECK VALVE
27	EEAC334-41	1/8GAS FILTER FITTING
28	EEAC330-96	FILTER MANIFOLD
29	EEAC330-97	NIPPLE 1/8GAS-3/8SAE
30	EEAC330-23B	DRYER FILTER
32	EEAC330-42	FRONT PLASTIC COVER
36	EEAC330-59	FRONT CASTER WITH BRAKE
37	CRP5024	FRONT CASTER SPACER
38	CRP4198	FOOT BRACKET
39	RAC6020	REAR WHEEL SPACER
40	EEAC330-60	300MM REAR WHEEL
41	EEAC330-61	REAR WHEEL RETAINER

REF#	PART NUMBER	DESCRIPTION
42	EEAC330-67	REAR WHEEL CAP
43	EEAC330-35	LEFT PLASTIC COVER
44	EEAC330-38	PLASTIC POCKET
45	CRP5018	SIDE CONNECTION PLATE
46	EEAC331-4	SIDE CONNECTION STICKER
47	EEAC330-93	NIPPLE 1/8GAS-1/4SAE
48	M16NUT	M16 NUT
49	EEAC333-10	HP QUICK FITTING
50	EEAC332-2	SCHRADER VALVE
51	EEAC330-68	PROTECTION HP HOSE OUTLET
52	EEAC330-21	USB PORT
53	EEAC330-68	PROTECTION LP HOSE OUTLET
54	EEAC332-2	SCHRADER VALVE
55	EEAC333-11	LP QUICK FITTING
56	M16NUT	M16 NUT
57	EEAC330-93	NIPPLE 1/8GAS-1/4SAE
70	EEAC330-37	REAR PLASTIC COVER
71	EEAC330-14	CORD WRAP
73	EEAC330-18	CABLE GUIDE FOR POWER CABLE
76	EEAC330-19	MAIN SWITCH (CIRCUIT BREAKER)

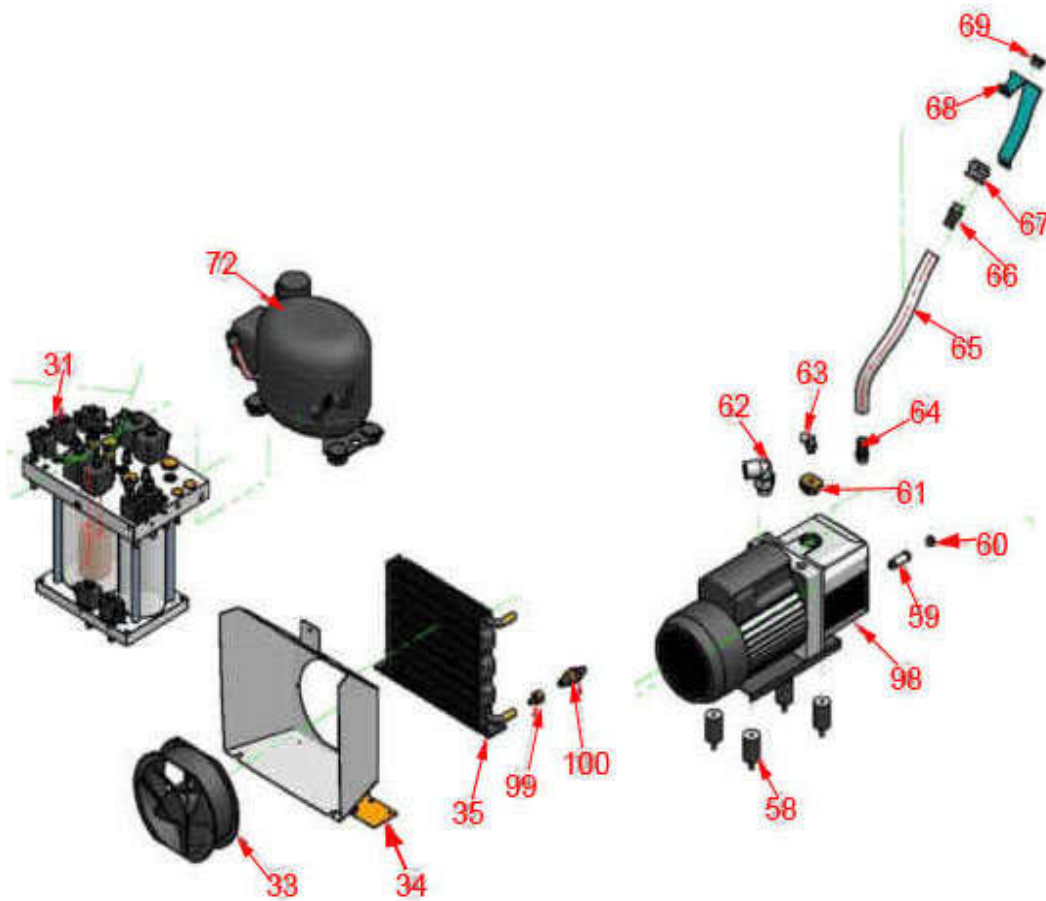

REF#	PART NUMBER	DESCRIPTION
31	EEAC333B-1	MANIFOLD
33	EEAC333-7	FAN FOR CONDENSER
34	CRP5022	FAN AIR DUCT
35	EEAC333-9	CONDENSER (WITHOUT FAN)
58	EEAC330-49	ANTIVABRION RUBBER
59	EEAC330-116	OIL DRAIN EXTENSION
60	EEAC334-49	OIL DRAIN CAP
61	EEAC330-117	FITTING M24 - 1/8GAS
62	EEAC334-42	10MM ELBOW OGIVE FITTING
63	EEAC334-48	6MM ELBOW OGIVE FITTING
64	EEAC334-43	HOSE FITTING 16MM
65	EEAC334-44	OIL PUMP FILLING HOSE
66	EEAC334-45	HOSE FITTING 16MM
67	EEAC334-47	MOUNT ADAPTER FITTING
68	EEAC330-118	VAC PUMP FILLING BRACKET
69	EEAC334-46	OIL PUMP FILLING CAP
72	EEAC333B-4	COMPRESSOR
99	RAC5190	WELD FITTING 1/4SAE FEMALE
100	EEAC330-82	1/4SAE CHECK VALVE

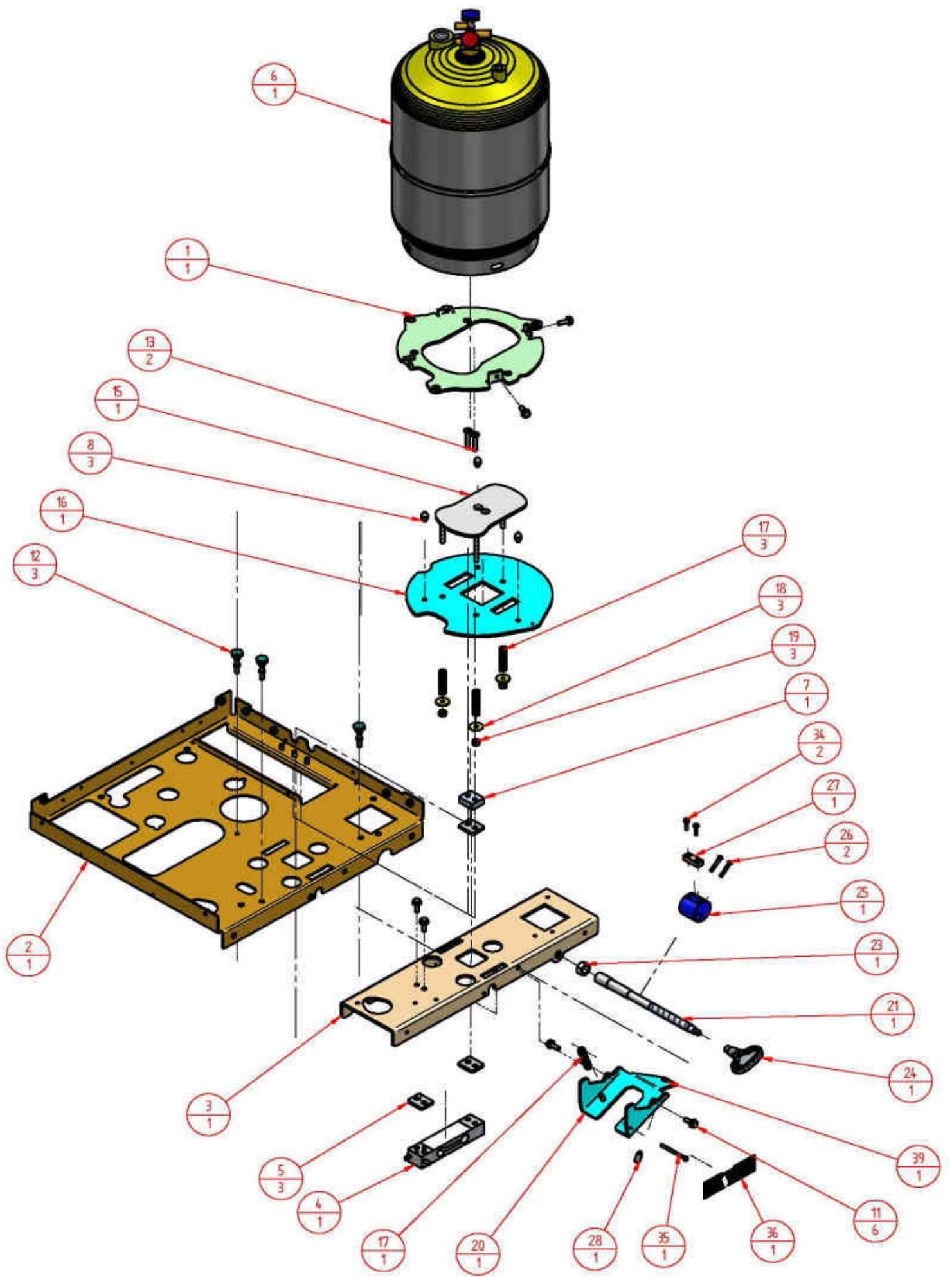



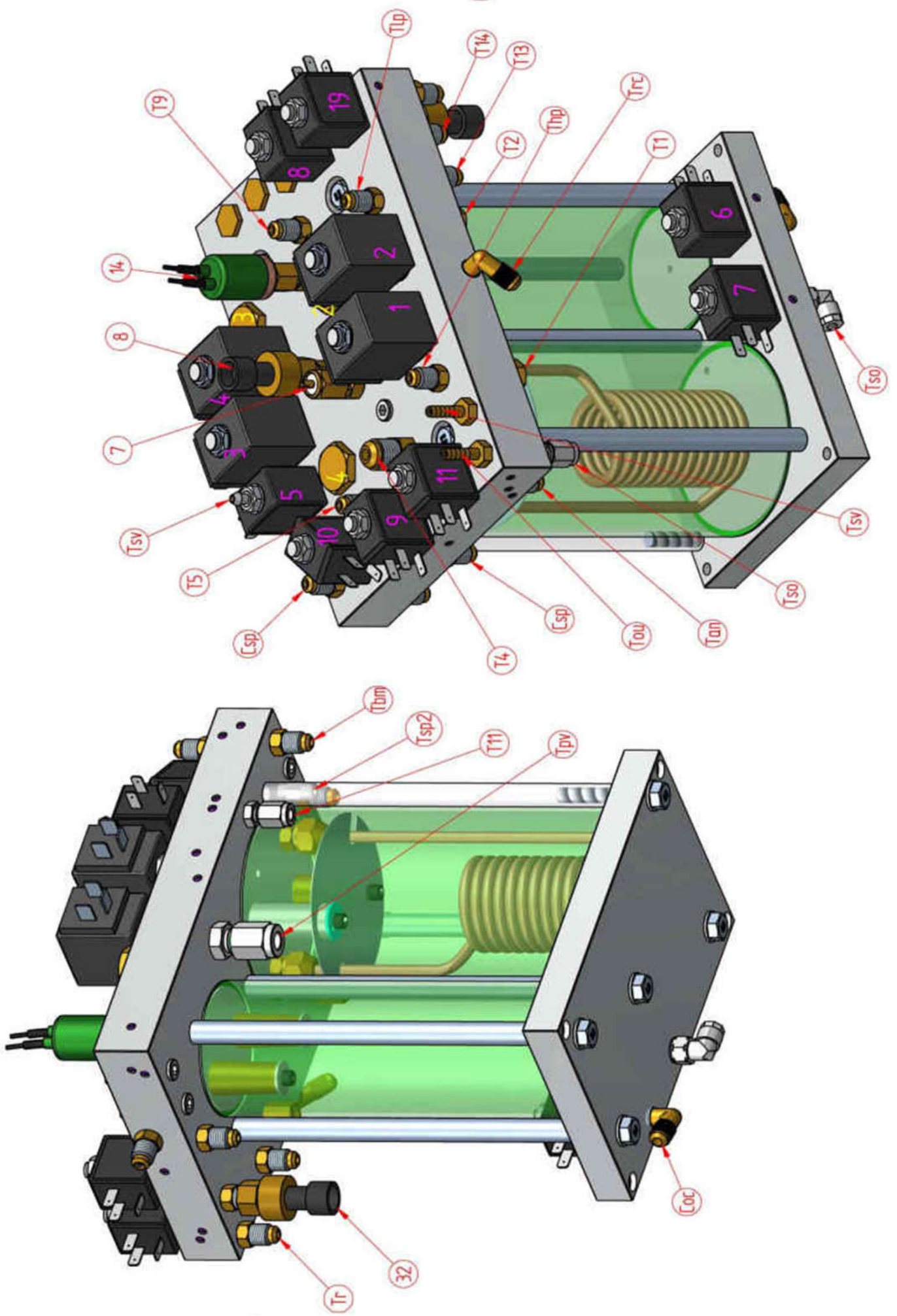













REF#	PART NUMBER	DESCRIPTION
1	CRP5050	TANK PLATE2
2	CRP5047	MIDDLE LEVEL FRAME
3	CRP5048	MIDDLE LEVEL FRAME REINFORCEMENT
4	EEAC330-9	TANK SCALE - 35KG
5	EEAC330-12	SCALE SPACER 4MM
6	EEAC330-11	REFRIGERANT STORAGE TANK
7	EEAC330-100	SCALE SPACER 10MM
8	EEAC330A-4	TANK PLATE CENTRING PIN
11	VIT0069	M6 SCREW
12	EEAC330A-5	TANK PLATE STOP SCREW
13	VIT0024	M6 SCREW
15	CRP5051	DUNPER PLATE
16	CRP5049	TANK PLATE1
17	EEAC334-56	COMPRESSION SPRING
18	VIT0004	WASHER FOR COMPRESSION SPRING
19	VIT0023	M6 NUT
20	CRP5052	TANK LOCK LEVER
21	RAC5206	LOCK LEVER SHAFT
23	VIT0070	M12 NUT
24	EEAC330A-3	TANK LOCK/UNLOCK HANDLE
25	RAC5208	CAM
26	VIT0064	M4 SCREW
27	RAC5209	CAM PLATE
28	EEAC330A-6	THREADED BALL SPRING PLUNGER
34	VIT0065	M4 SCREW
35	VIT0063	LOCKED/UNLOCKED SCREW
36	EEAC330A-1	LOCKED/UNLOCKED STICKER
39	RACXXXX	THREADED BALL SPRING FITTING

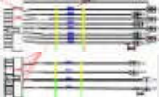

REF#	PART NUMBER	DESCRIPTION
1	ELT1171	EV1 HIGH PRESSURE SOLENIOD VALVE
1A	VLV1170	EV1 HIGH PRESSURE SPOOL VALVE
2	ELT1171	EV2 LOW PRESSURE SOLENIOD VALVE
2A	VLV1170	EV2 LOW PRESSURE SPOOL VALVE
3	ELT1171	EV3 OUTLET EVAPORATOR SOLENIOD VALVE
3A	VLV1170	EV3 OUTLET EVAPORATOR SPOOL VALVE
4	ELT1171	EV4 INLET VACUUM SOLENIOD VALVE
4A	VLV1170	EV4 INLET VACUUM SPOOL VALVE
5	ELT1175	EV5 OUTLET VACUUM SOLENIOD VALVE
5A	VLV1177	EV5 OUTLET VACUUM SPOOLVALVE
6	ELT1175	EV6 OIL COMPR. REFILL SOLENIOD VALVE
6A	VLV1175	EV6 OIL COMPRESSOR REFILL SPOOL VALVE
7	ELT1175	EV7 OIL DISCHARGE SOLENIOD VALVE
7A	VLV1175	EV7 OIL DISCHARGE SPOOL VALVE
8	ELT1175	EV8 REFILLING SOLENIOD VALVE
8A	VLV1175	EV8 REFILLING SPOOL VALVE
9	ELT1175	EV9 EVAP. OVERPRESSURE SOLENIODVALVE
9A	VLV1175	EV9 EVAPORATOR OVERPRESSURE SPOOL VALVE
10	ELT1175	EV10 AIR PURGE SOLENIOD VALVE
10A	VLV1175	EV10 AIR PURGE SPOOL VALVE
11	ELT1175	EV11 GAS ANALYZER SOLENIOD VALVE
11A	VLV1175	EV11 GAS ANALYZER SPOOL VALVE
19	ELT1175	EV19 WASHING PIPES (HYBRID)
19A	VLV1175	EV19 WASHING PIPES (HYBRID)
7	EEAC330-84	SAFETY VALVE (12BAR)
8	EEAC330-69	A/C PRESSURE TRANSDUCER
14	EEAC330-48	SAFETY PRESSURE SWITCH (20 BAR)
T1	EEAC331-21	HIGH PRESSURE FITTING-EV1
T2	EEAC331-22	LOW PRESSURE FITTING-EV2
T4	TUBX085	EVAPORATOR-FILTER

















REF#	PART NUMBER	DESCRIPTION
T5	TUBX086	MANIFOLD HEATER-CONDENSER
T9	EEAC330-127	COMPRESSOR-OIL SEPARATOR
T10	EEAC330-114	CK1-COMPRESSOR
T13	TUBX067	EV19-HP MALE COUPLING
T14	TUBX068	EV19-LP MALE COUPLING
TSO	EEAC330-77	OIL DISCHARGE BYPASS
CSP	EEAC330-90	AIR PURGE BYPASS
TSP2	EEAC330-91	AIR PURGE BYPASS
TB	EEAC330-73	CONDENSER-REFRIGERANT BOTTLE (LP SIDE)
TR	EEAC330-74	REFRIGERANT BOTTLE (HP SIDE)-MANIFOLD
TPV	EEAC330-78	EV4-VACUUM PUMP
TSV	EEAC330-76	VACUUM PUMP DISCHARGE
TOU	EEAC330-76	MANIFOLD-USED OIL CONTAINER
COC	EEAC330-89	EV6-COMPRESSOR
TBM	EEAC330-89	TANK 3RD CONNECTION - EV9
TLP	EEAC330-89	MANIFOLD-LP MANOMETER
THP	EEAC330-89	MANIFOLD-HP MANOMETER
TRC	EEAC330-89	MANIFOLD-CONTAMINATED REFRIGERANT FITTING
TAN	EEAC330-89	EV11-GAS ANALYZER
T11	EEAC330-77	PUMP-EV5
32	EEAC330-69	BOTTLE PRESSURE TRANSDUCER
TSP2	EEAC330-91	AIR PURGE BYPASS
TB	EEAC330-73	CONDENSER-REFRIGERANT BOTTLE (LP SIDE)
TR	EEAC330-74	REFRIGERANT BOTTLE (HP SIDE)-MANIFOLD
TPV	EEAC330-78	EV4-VACUUM PUMP
TSV	EEAC330-76	VACUUM PUMP DISCHARGE
TOU	EEAC330-76	MANIFOLD-USED OIL CONTAINER
COC	EEAC330-89	EV6-COMPRESSOR
TBM	EEAC330-89	TANK 3RD CONNECTION - EV9

















SNAPON PART NUMBER	IMAGE	DESCRIPTION
EEAC330-1		PRINTER STICKER
EEAC330-1		GROUND STICKER
EEAC330-3		USED OIL STICKER
EEAC333-1		R1234yf BOTTLE STICKER
EEAC331-4		SIDE CONNECTION STICKER
EEAC332-1		CONTROL PANEL
EEAC333-3		HIGHSIDE QUICK COUPLER
EEAC333-4		LOWSIDE QUICK COUPLER
EEAC333-5		LOWSIDE ADAPTER R1234yf (Dupont)
EEAC330-124		LOAD CELL 50Kg
EEAC330-10		LOAD CELL 15Kg
EEAC330-11		30lb STORAGE BOTTLE
EEAC330-12		SPACER SCALE PLATE
EEAC330-13		FILTER WRENCH
EEAC330-14		CORD WRAP
EEAC330-17		POWER CORD

SNAPON PART NUMBER	IMAGE	DESCRIPTION
EEAC331B-1		7" DISPLAY SHEET METAL
EEAC331B-2		CONTROL PANEL SHEET METAL
EEAC333-26		MANIFOLD YF
EEAC330B-2		TANK HEATER
EEAC331B-4		PRINTER CABLE
EEAC330B-4		POWER SUPPLY CABLE
EEAC333B-4		R134a COMPRESSOR
EEAC333-9		CONDENSER W/FAN
GRELT050		SOLENOID WIRING HARNESS
EEAC331B-7		7" DISPLAY FRAME
EEAC330B-11		WIFI ANTENNA
EEAC330B-12		POWER SUPPLY
EEAC331B-8		FLAT CABLE DISPLAY ADAPTER
EEAC331B-9		NEVOPLUS MOTHER BOARD
EEAC331B-13 or EEAC331B-14		7" DISPLAY
EEAC331B-11		50PIN FLAT CABLE (EEAC331B-8)
EEAC331B12		4 PIN FLAT CABLE (EEAC331B-8)













SNAPON PART NUMBER	IMAGE	DESCRIPTION
EEAC330-18		CABLE GUIDE
EEAC330-19		POWER SWITCH W/BREAKER
EEAC330-21		USB CABLE
EEAC330-22		PRESSURE TRANS. HARNESS
EEAC330-23B		FILTER DYER
EEAC330-27		USED OIL BOTTLE
EEAC330-28		F1/4 CAP W/GASKET
EEAC330-29		FOAM POCKET
EEAC330CVR		SINGLE GAS COVER
EEAC331-9		HIGHSIDE PRESSURE GAUGE
EEAC330-10		LOWSIDE PRESSURE GAUGE
EEAC330-35		LEFT SIDE PLASTIC COVER
EEAC330-36		RIGHT SIDE PLASTIC COVER
EEAC330-37		REAR PLASTIC COVER
EEAC330-38		SIDE POCKET
EEAC330-39		OIL DOOR





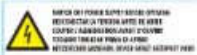





SNAPON PART NUMBER	IMAGE	DESCRIPTION
EEAC330-40		FILTER DOOR
EEAC330-41		OIL DOOR CAP
EEAC330-42		FRONT PLASTIC COVER
EEAC330-43		UPPER PLASTIC COVER
EEAC331-11		7" DISPLAY FRAME
EEAC331-12		LED COVER
EEAC331-18		LED BOARD
GRSTM0007D		PRINTER
EEAC331-20		THERMAL PRINTER PAPER
ELT1045-C		ELECTRONIC VALVE
ELT1165		ELECTRONIC VALVE
VLV1450-N		SPOOL VALVE
VLV7000		3 WAY SPOOL VALVE
VLV1160-N		SPOOL VALVE
EEAC330-80		CHECK VALVE
EEAC330-55		1/8 M/F BALL VALVE

SNAPON PART NUMBER	IMAGE	DESCRIPTION
ACT71-0A		VACUUM PUMP OIL
EEAC331-13		VACUUM PUMP
EEAC330-49		RUBBER ISOLATORS
EEAC330-48		20 BAR SAFETY SWITCH
EEAC330-69		PRESSURE TRANSDUCER
EEAC332-2		BIG DEPRESSOR VALVE
EEAC330-50		LITTLE DEPRESSOR VALVE
EEAC333-10		HP CONNECTOR R1234yf
EEAC333-11		LP CONNECTOR r1234yf
EEAC330-54		1/4 DOUBLE UNION
EEAC330-56		CAL. REF. WEIGHT
EEAC330-57		RED OIL DRAIN FITTING
EEAC330-59		FRONT CASTER W/LOCK
EEAC330-60		REAR WHEEL
EEAC330-61		REAR WHEEL RETAINER
EEAC330-67		REAR WHEEL CAP
EEAC330-113		REAR WHEEL AXLE

SNAPON PART NUMBER	IMAGE	DESCRIPTION
EEAC330-66		TEMP. SENSOR
EEAC330-68		CABLE GUIDE
EEAC330-89		100cm COPPER HOSE
EEAC330-90		50cm COPPER HOSE
EEAC333A-1		95cm BLUE HOSE W/BALL VALVE
EEAC333A-2		95cm RED HOSE W/BALL VALVE
EEAC333-12		3.8m BLUE HOSE
EEAC333-13		3.8m RED HOSE
EEAC333-8		ANALYZER FILTER
EEAC333-6		LOWSIDE ADAPTER R1234yf (HONEY WELL)
EEAC330-76		4X2.5 POLY TUBE
EEAC330-75		10m POLY HOSE
EEAC330-77		4X6 POLY HOSE
EEAC330-78		8X10 POLY TUBE
EEAC330-116		10mmX3/8 GAS ELBOW FITTING
EEAC333-27		R134a NIPPLE 1/8 GASX 1/2 ACME

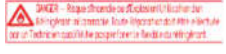
SNAPON PART NUMBER	IMAGE	DESCRIPTION
EEAC330-82		CHECK VALVE M1/4 SAE
EEAC330-83		CHECK VALVE M3/8 SAE
EEAC330-84		12 BAR SAFETY VALVE
EEAC330-85		1 BAR SAFETY VALVE
EEAC330-93		1/8 GAS X 1/4 SAE
EEAC330-95		M1/4 SAE X 3/8 SAE
EEAC330-97		1/8 GAS X 3/8 SAE
EEAC334-48		6mm ELBOW FITTING
EEAC334-41		1/8 GAS FILTER FITTING
EEAC334-43		16mm HOSE FITTING
EEAC334-44		VACUUM PUMP OIL FILL TUBE
EEAC334-45		16mm HOSE FITTING
EEAC334-46		OIL FILLING CAAP
EEAC334-47		MOUNT ADPATER FITTING
EEAC334-49		OIL DRAIN CAP
EEAC334-56		COMPRESSION SPRING

SNAPON PART NUMBER	IMAGE	DESCRPTION
EEAC330-94		TANK PLATE MAGNET
EEAC330-96		DRYER FILTER MANIFOLD
EEAC330-99		MAGNET FLARED HOLE
EEAC330A-1		TANK UNLOCK STICKER 1
EEAC330A-2		TANK UNLOCK STICKER 2
EEAC330A-3		LOCK UNLOCK KEY
EEAC330A-4		TANK CENTERING PIN
EEAC330A-5		TANK PLATE STOP SCREW
EEAC330A-6		TANK PLATE BALL PLUNGER
EEAC330-100		10mm SPACER SCALE
EEAC330-102		WARNER STICKER (EN)
EEAC330-103		WARNING STICKER (FR)
EEAC330-121		UL SWITCH STICKER
EEAC330-108		O-RING KIT FILTER DRYER
EEAC330-109		LUBE
EEAC330-112		O-RING 1/4 CAP SCREW

SNAPON PART NUMBER	IMAGE	DESCRIPTION
EEAC330-132		12 PIN MOTHER BOARD CONNCTOR
EEAC330-120		POWER SUPPLY COVER
EEAC330-119		CONTROL PANEL FIXING BRACKET
EEAC330-118		OIL FILL BRACKET
EEAC330-117		1/8 X M24 FITTING
EEAC330-16		OIL DRAIN EXTENSION
EEAC331-27		STATUS LIGHT WIRING HARNESS
EEAC330-128		1/4 COPPER GASKET
EEAC330-129		3/8 COPPER GASKET
EEAC333-21		SNP16 WARNING STICKER (EN) 1
EEAC333-22		SNP16 WARNING STICKER (EN) 2
EEAC333-23		SNP16 WARNING STICKER (FR) 1
EEAC333-24		SNP16 WARNING STICKER (FR) 2
EEAC333-29		MESH SCREEN
EEAC333-35		O2 SENSOR
EEAC333-18		ANALYZER
EEAC333-16		GAS ANALYZER HOSE W/ REDUCER



Notice: The information contained in this document is subject to change without notice. Snap-on Equipment makes no warranty with regard to this material. Snap-on Equipment shall not be liable for errors contained herein or for incidental consequential damages in connection with furnishings, performance, or use of this material.

This document contains proprietary information which is protected by copyright and patents. All rights are reserved. No part of this document may be photocopied, reproduced, or translated without prior written consent of Snap-on Equipment