

ECOTECHNICS

ECO DUAL GAS



EEAC800

**R134a and R1234yf Refrigerant
Recovery / Recycle / Recharge
Service Vehicle A/C System**

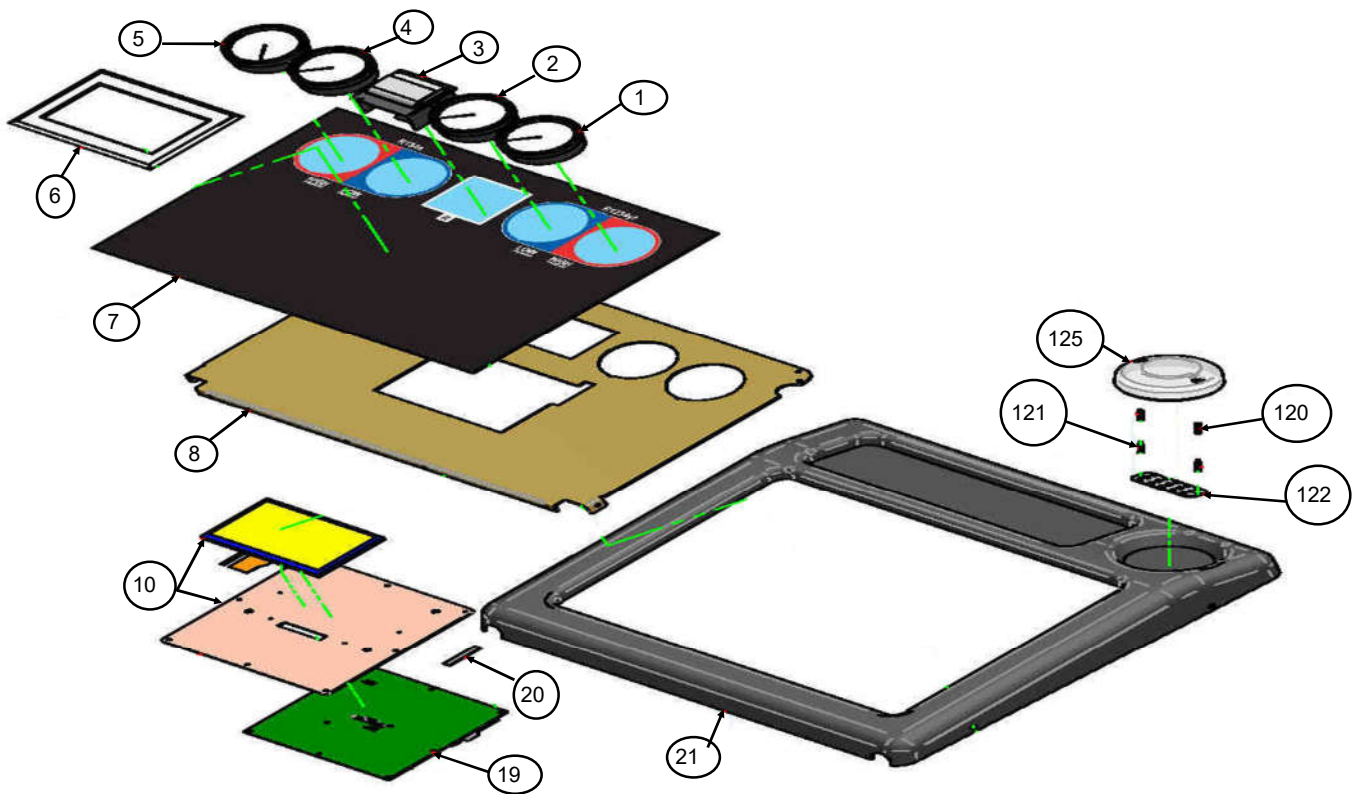

REF#	PART #	DESCRIPTION
1	EEAC330-30	GAUGE HP R1234YF
2	EEAC330-31	GAUGE LP R1234YF
3	GRSTM0007D	THERMAL PRINTER
4	EEAC330-31	GAUGE LP R134A
5	EEAC330-30	GAUGE HP R134A
6	EEAC331B-7	DISPLAY FRAME 7"
7	ADE6514	COMMAND PANEL STICKER
8	CRP5177	COMMAND PANEL SHEET METAL
10	GRSCH5012 OR GRSCH5012RT	DISPLAY SUPPORT SHEET METAL W/ 7" DISPLAY
19	SCH1910	MOTHERBOARD WITHOUT DISPLAY
21	PLA2522-NA00	TOP PLASTIC COVER
120	RAC6103	SPACER 20MM
121	RAC6124	SPACER 15MM
122	EEAC331-18	LED MOTHERBOARD
NS	EEAC331-27	STATUS LIGHT WIRING
125	PLA2605-00	LED PLASTIC COVER

ECOTECHNICS

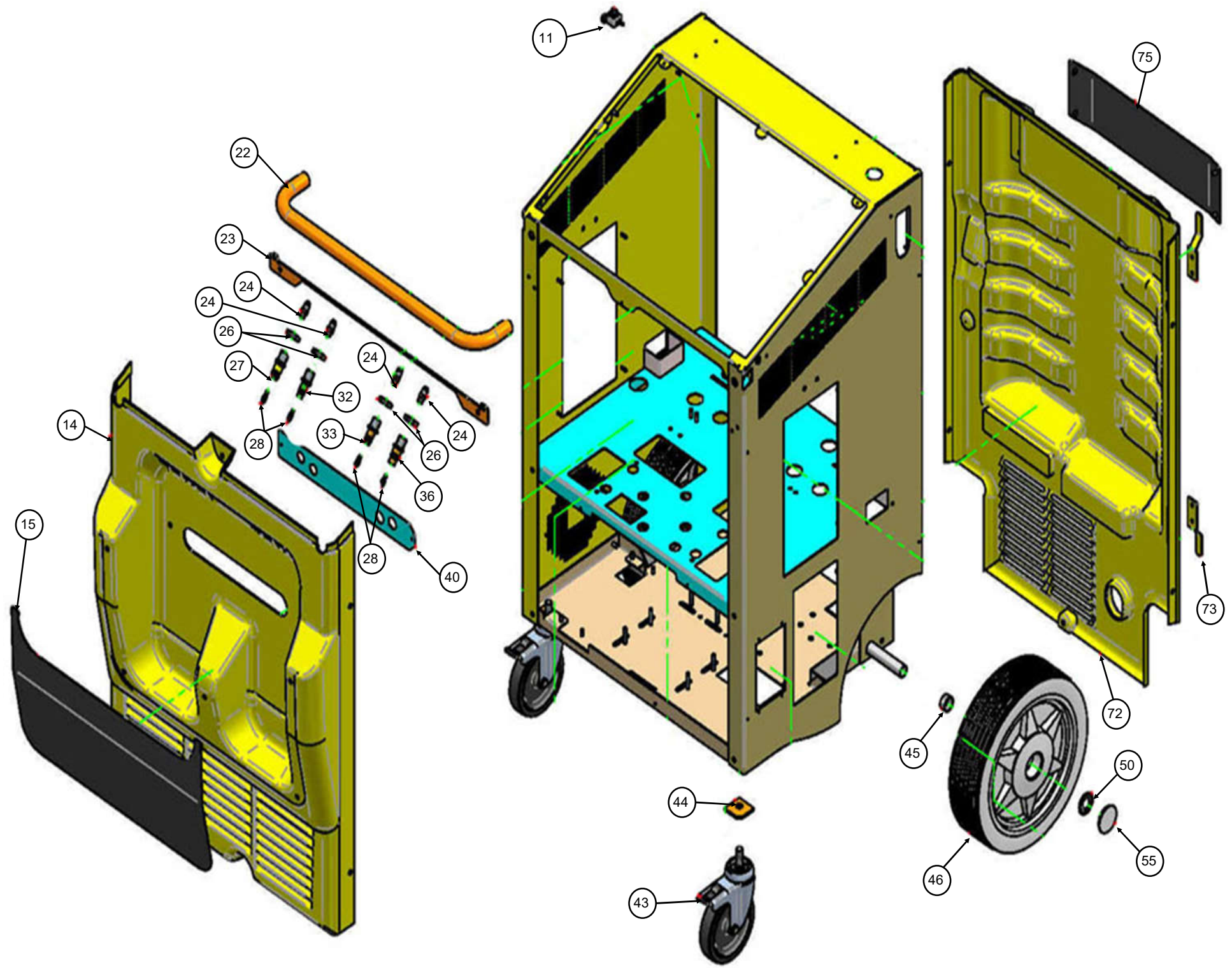

REF#	PART #	DESCRIPTION
14	EEAC800-14	FRONT PLASTIC COVER
15	CRP3856	FRONT POCKET
22	CRP3803	FRONT HANDLE
23	CRP3980	HYBRID SUPPORT SHEETMETAL
24	EEAC330-93	NIPPLE 1/4 SAE
26	VIT0028	M16 NUT
27	EEAC332-3	HYBRID QUICK FITTING HP R134A
28	EEAC332-2	SCHRADER VALVE
32	EEAC332-4	HYBRID QUICK FITTING LP R134A
33	EEAC333-11	HYBRID QUICK FITTING LP R1234YF
36	EEAC333-10	HYBRID QUICK FITTING HP R1234YF
N/S	TUB2147	R134A LOWSIDE SERVICE HOSE
N/S	AEK228B	QUICK COUPLER LP F14X1,5 R134A
N/S	TUB246	R134A HIGHSIDE SERVICE HOSE
N/S	AEK228A	QUICK COUPLER HP F14X1,5 R134A
43	RUO7070	FRONT WHEEL
44	CRP3625	FRONT WHEEL SPACER
45	CRP6020	REAR WHEEL SPACER
46	RUO7071	REAR WHEEL
50	EEAC330-61	REAR WHEEL RING STOPPER
51	TAP7121	REAR WHEEL CAP
72	PLA2521-NA00	REAR PLASTIC COVER
73	CRP3766	POWER CABLE HOOK
75	CRP3801	REAR POCKER
N/S	EEAC330-17	POWER CORD
119	EEAC330-19	POWER MAIN SWITCH
N/S	TUB2132	R1234YF LOWSIDE SERVICE HOSE
N/S	AEK229B	QUICK COUPLER LP FOR HFO
N/S	TUB2122	R1234YF HIGHSIDE SERVICE HOSE
N/S	AEK229A	QUICK COUPLER HP FOR HFO

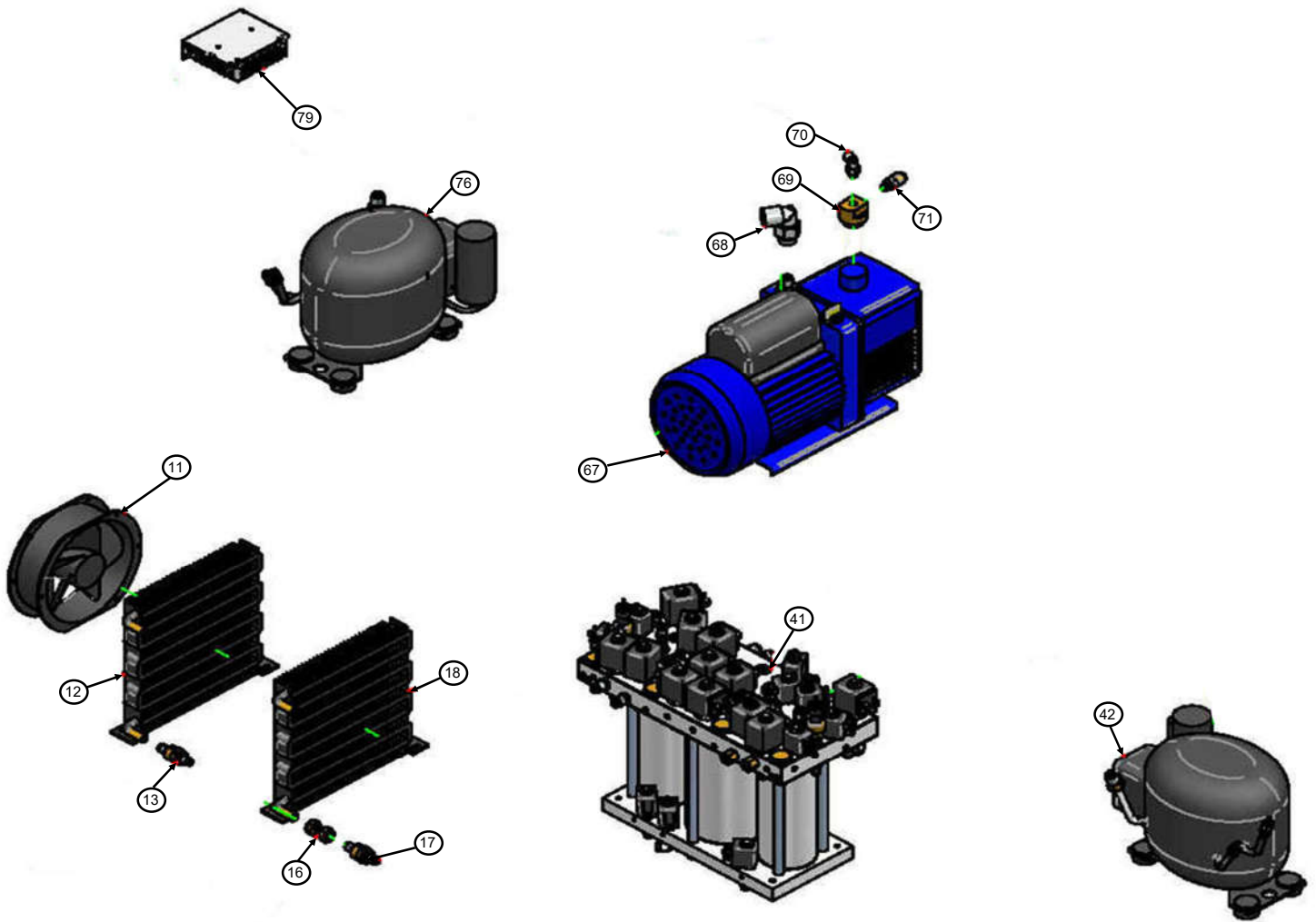

REF#	PART #	DESCRIPTION
11	EEAC333-36	CONDENSER FAN
12	GRCND07	CONDENSER R134A
13	EEAC330-82	CHECK VALVE
16	EEAC330-54	DOUBLE PIPE UNION
17	EEAC330-82	CHECK VALVE
18	EEAC333-9	CONDENSER R1234YF
41	DIS7310	MANIFOLD
42	EEAC333B-4	COMPRESSOR R1234YF
67	EEAC331-13	VACUUM PUMP 6 CFM
68	EEAC330-106	L FITTING 10MM
69	RAC8099-OT	VACUUM PUMP FITTING M24
70	EEAC334-48	L FITTING 6MM
71	EEAC330-85	SAFETY VALVE 1 BAR
76	GRCMP20-A	COMPRESSOR R134A

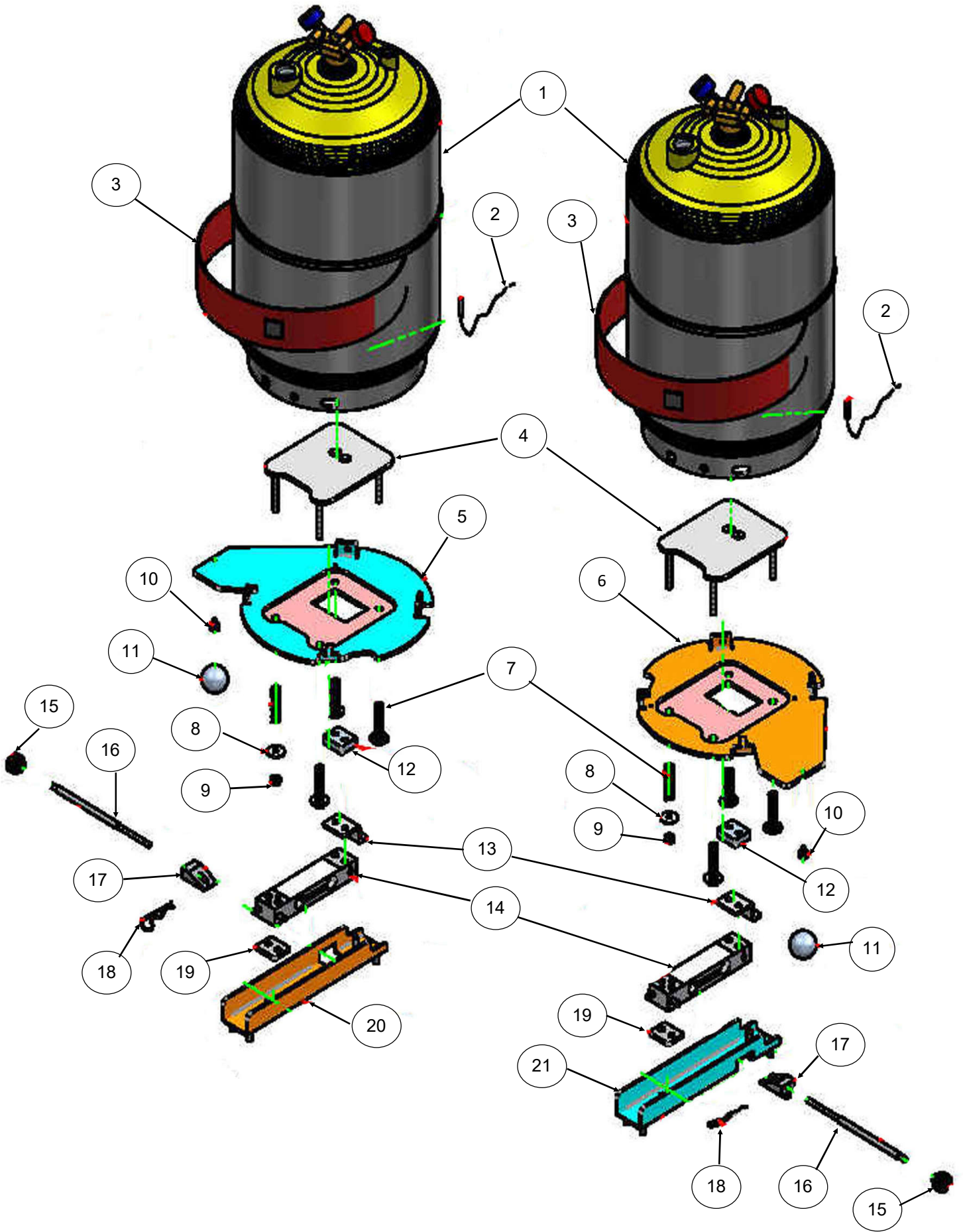

REF#	PART #	DESCRIPTION
1	EEAC330-11	REFRIGERANT TANK
2	EEAC330-66	TEMPERATURE PROBE
3	EEAC330-20	THERMAL HEATER
4	CRP5054	TANK PLATE2 SUPPORT
5	CRP5181	TANK PLATE SUPPORT
6	CRP5182	TANK PLATE SUPPORT
7	EEAC334-56	COMPRESSION SPRING
8	VIT0004	WASHER FOR COMPRESSION SPRING
9	VIT0023	M6 NUT FOR COMPRESSION SPRING
10	EEAC334-14	REFERENCE WEIGHT MAGNET
11	EEAC330-56	REFERENCE WEIGHT
12	EEAC330-100	LOAD CELL SPACER 10MM
13	CRP5173	TANK LOAD CELL STOP
14	EEAC330-124	TANK R134A LOAD CELL 50KG
15	RAC6521	LOAD CELL STOP KNOB
16	RAC5217	THREADED SHAFT
17	RAC6526	LOAD CELL STOP WEDGE
18	RAC6527	COTTER ELASTIC PIN
19	EEAC330-12	LOAD CELL SPACER 6MM
20	CRP5183	LOAD CELL R134A REINFORCEMENT
21	CRP5184	LOAD CELL R1234YF REINFORCEMENT
N/S	EEAC330-73	BLUE HOSE 90 CM F1/4" - F1/4" SAE WITH BALL VALVE
N/S	EEAC330-74	RED HOSE 90 CM F1/4" - F1/4" SAE WITH BALL VALVE

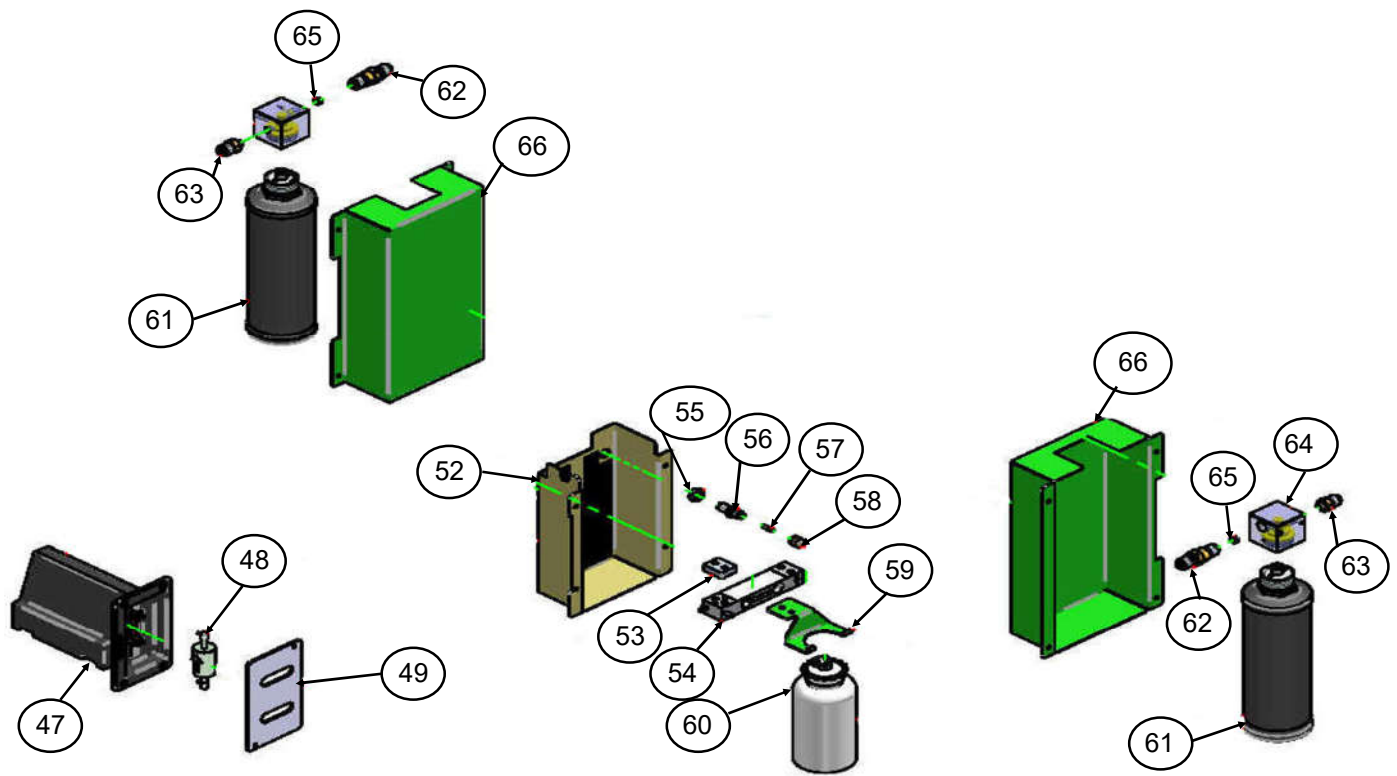

REF#	PART #	DESCRIPTION
47	EEAC334-21	GAS ANALYZER
48	EEAC333-8	GAS ANALYZER FILTER
49	PLA2600-00	GAS ANALYZER FILTER PROTECTION
50	EEAC330-61	REAR WHEEL RING STOPPER
51	TAP7121	REAR WHEEL CAP
52	CRP5082	USED OIL SHEET METAL BOX
53	EEAC330-100	LOAD CELL SPACER 10MM
54	EEAC330-10	USED OIL LOAD CELL
55	RAC4100	NUT 1/4 SAE
56	EEAC334-52	BULKHEAD FITTING 1/4 SAE
57	EEAC330-50	SCHRADER VALVE
58	EEAC330-28	CAP 1/4SAE WITH GASKET
59	EEAC334-53	USED OIL SUPPORT BRACKET
60	EEAC334-22	USED OIL CONTAINER
61	EEAC330-23B	DRYER FILTER
62	EEAC330-83	CHECK VALVE 3/8 SAE
63	EEAC330-97	NIPPLE 3/8 SAE
64	EEAC330-96	DRYER FILTER ALUMINUM MANIFOLD
65	EEAC334-41	FILTER FITTING 1/8 GAS
66	CRP5080	DRYER FILTER SHEET METAL BOX
N/S	EEAC333-35	O2 SENSOR GAS ANALYZER

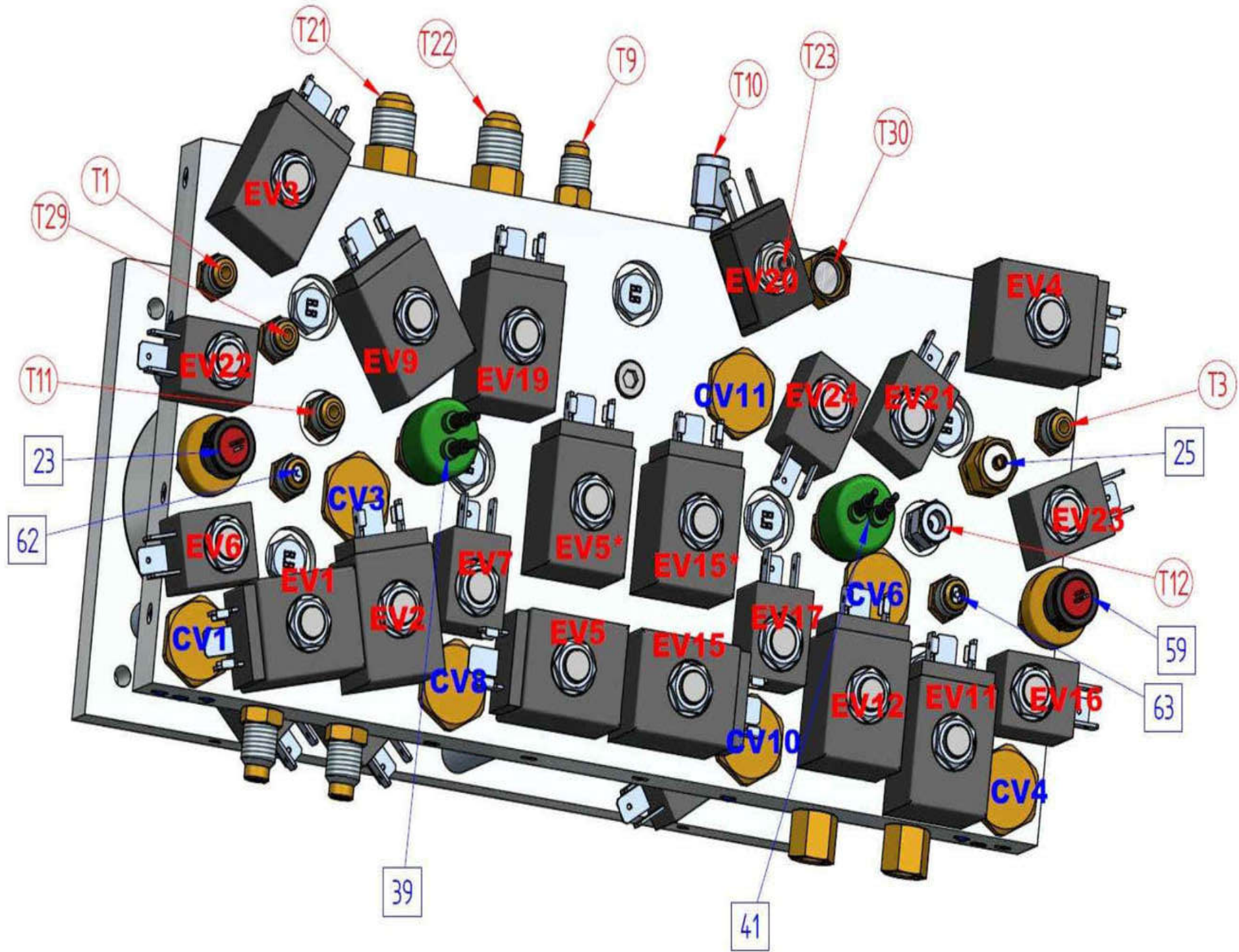

REF#	PART #	DESCRIPTION
EV1	ELT1171	R134A HIGH PRESSURE ELECTRONIC VALVE
EV1	VLV1170	R134A HIGH PRESSURE SPOOL VALVE
EV2	ELT1171	R134A LOW PRESSURE ELECTRONIC VALVE
EV2	VLV1170	R134A LOW PRESSURE SPOOL VALVE
EV3	ELT1171	R134A INLET VAC PUMP ELECTRONIC VALVE
EV3	VLV1170	R134A INLET VAC PUMP SPOOL VALVE
EV4	ELT1171	R1234YF INLET VAC PUMP ELECTRONIC VALVE
EV4	VLV1170	R1234YF INLET VAC PUMP SPOOL VALVE
EV5	ELT1171	R134A EVAP ELECTRONIC VALVE
EV5	VLV1170	R134A EVAP SPOOL VALVE
EV5*	ELT1171	R134A EVAP ELECTRONIC VALVE
EV5*	VLV1170	R134A EVAP SPOOL VALVE
EV6	ELT1175	R134A REFILLING ELECTRONIC VALVE
EV6	VLV1175	R134A REFILLING SPOOL VALVE
EV7	ELT1175	R134A EVAP OVERPRESSURE ELECTRONIC VALVE
EV7	VLV1175	R134A EVAP OVERPRESSURE SPOOL VALVE
EV9	ELT1171	R134A INLET COMPRESSOR ELECTRONIC VALVE
EV9	VLV1170	R134A INLET COMPRESSOR SPOOL VALVE
EV11	ELT1171	R1234YF HIGH PRESSURE ELECTRONIC VALVE
EV11	VLV1170	R1234YF HIGH PRESSURE SPOOL VALVE
EV12	ELT1171	R1234YF LOW PRESSURE ELECTRONIC VALVE
EV12	VLV1170	R1234YF LOW PRESSURE SPOOL VALVE
EV15	ELT1171	R1234YF EVAPORATOR ELECTRONIC VALVE
EV15	VLV1170	R1234YF EVAPORATOR SPOOL VALVE
EV15*	ELT1171	R1234YF EVAPORATOR ELECTRONIC VALVE
EV15*	VLV1170	R1234YF EVAPORATOR SPOOL VALVE
EV16	ELT1175	R1234YF REFILLING ELECTRONIC VALVE
EV16	VLV1175	R1234YF REFILLING SPOOL VALVE
EV17	ELT1175	R1234YF EVAP OVERPRESSURE ELECTRONIC VALVE
EV17	VLV1175	R1234YF EVAP OVERPRESSURE SPOOL VALVE

REF#	PART #	DESCRIPTION
EV19	ELT1171	R1234YF INLET COMPRESSOR ELECTRONIC VALVE
EV19	VLV1170	R1234YF INLET COMPRESSOR SPOOL VALVE
EV20	ELT1175	OUTLET VACUUM PUMP ELECTRONIC VALVE
EV20	VLV1177	OUTLET VACUUM PUMP SPOOL VALVE
EV21	ELT1175	AIR PURGE ELECTRONIC VALVE
EV21	VLV1175	AIR PURGE SPOOL VALVE
EV22	ELT1175	R134A HYBRID ELECTRONIC VALVE
EV22	VLV1175	R134A HYBRID SPOOL VALVE
EV23	ELT1175	R1234YF HYBRID ELECTRONIC VALVE
EV23	VLV1175	R1234YF HYBRID SPOOL VALVE
EV24	ELT1175	GAS ANALYZER ELECTRONIC VALVE
EV24	VLV1175	GAS ANALYZER ELECTRONIC VALVE
CV1	EEAC330-80	CHECK VALVE
CV3	EEAC330-80	CHECK VALVE
CV4	EEAC330-80	CHECK VALVE
CV6	EEAC330-80	CHECK VALVE
CV8	EEAC330-80	CHECK VALVE
CV10	EEAC330-80	CHECK VALVE
CV11	EEAC330-80	CHECK VALVE
T1	TUBX128	EV22 - HP HYBRID FITTING R134A
T3	TUBX130-OT	EV23 - HP HYBRID FITTING R1234YF
T9	TUBX132	MANIFOLD HEATER - CONDENSER R134A
T10	TUBX133-AI	MANIFOLD HEATER - CONDENSER R1234YF
T11	TUBX134	COMPRESSOR OUTLET - MANIFOLD OIL SEPARATOR R134A
T12	TUBX135-AI	COMPRESSOR OUTLET - MANIFOLD OIL SEPARATOR R1234YF
T21	TUBX138	MANIFOLD EV9 - DRYER FILTER R134A
T22	TUBX139-OT	MANIFOLD EV19 - DRYER FILTER R1234YF



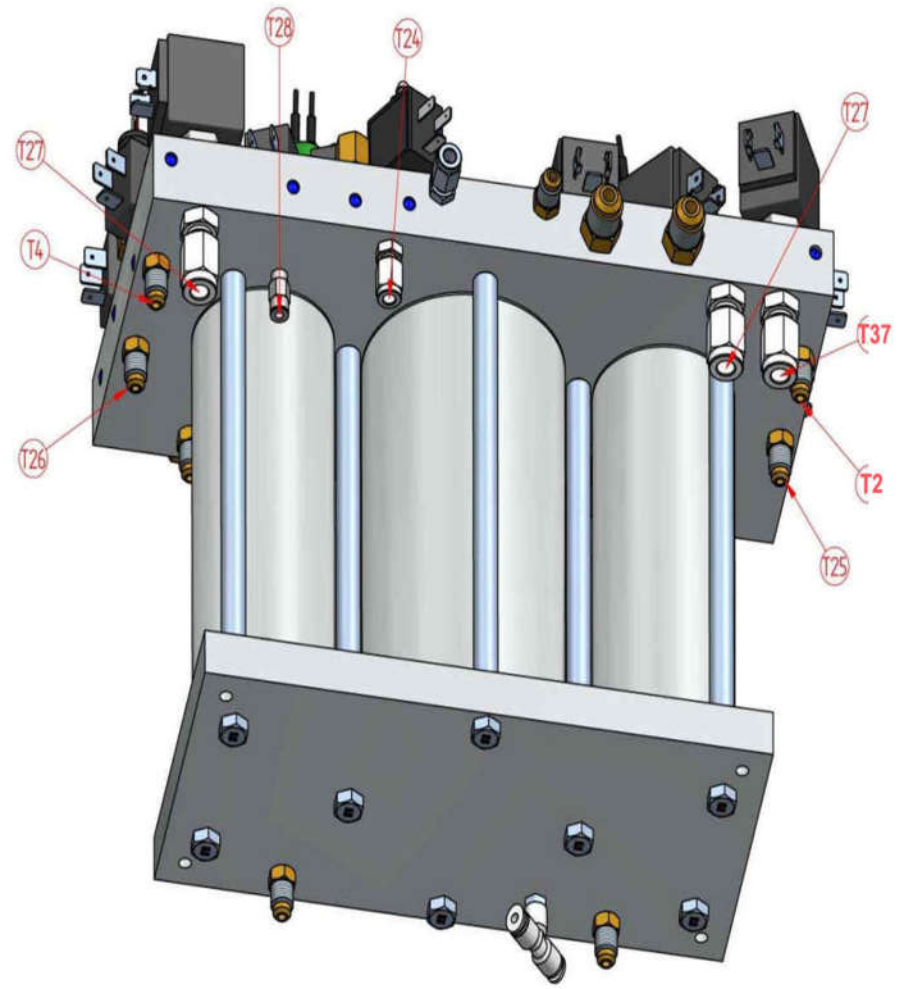
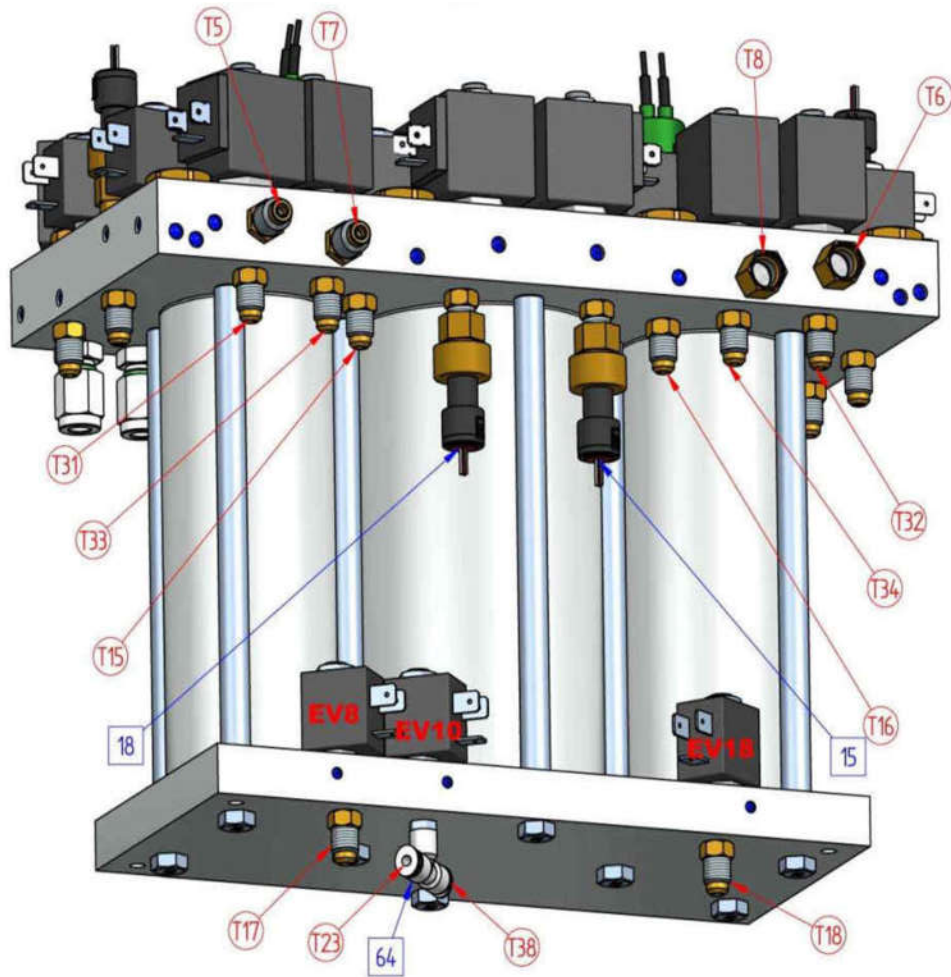



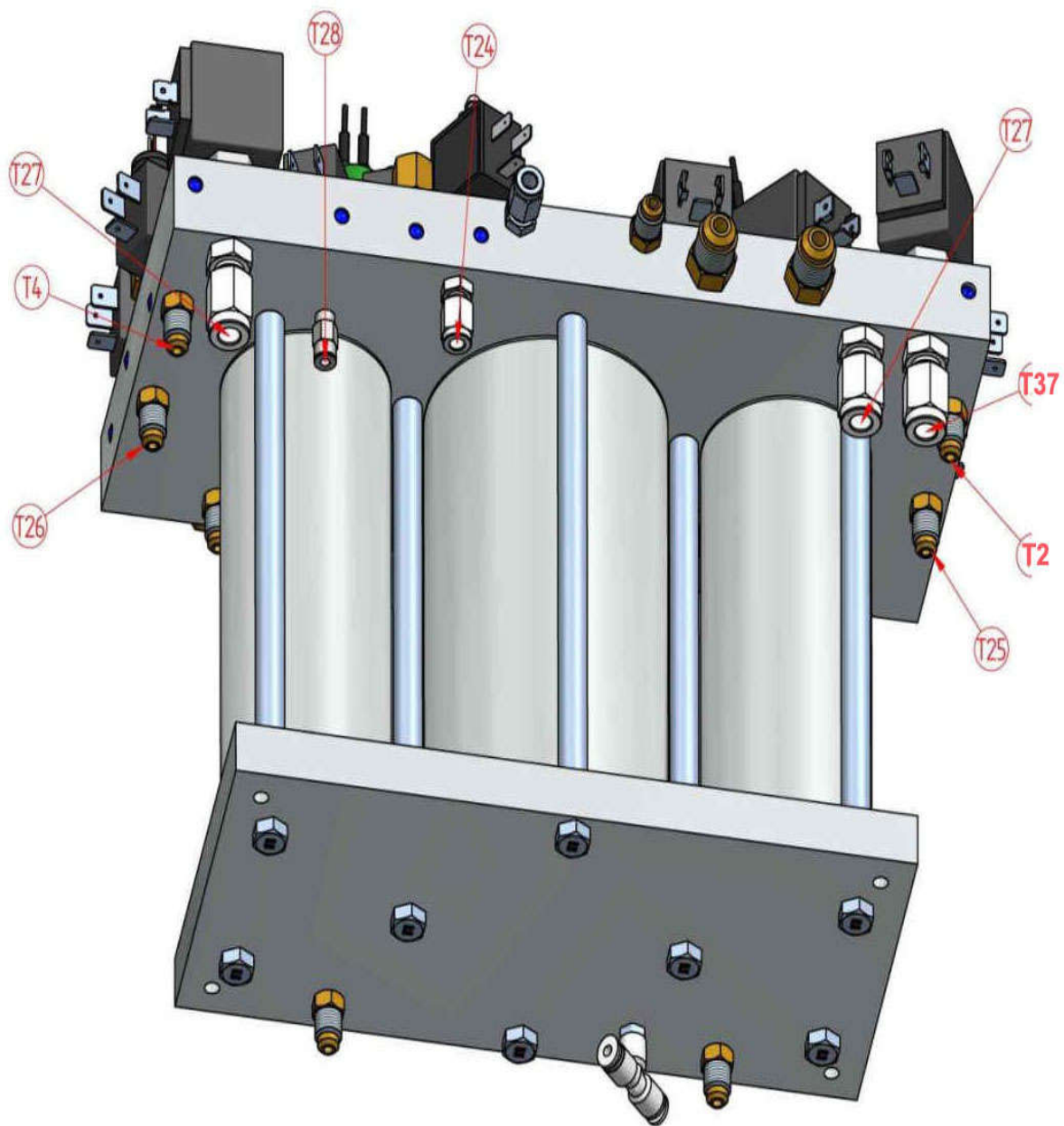



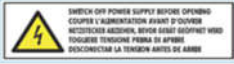



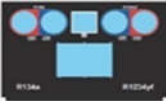

REF#	PART #	DESCRIPTION
T23	TUB1250	MANIFOLD EV20 UPPER OUTLET - USED OIL TEE FITTING
T29	TUB1224	MANIFOLD - CONTAMINATED REFRIGERANT PURGE FITTING
T30	TUB1260	MANIFOLD EV24 - GAS ANALYZER
23	EEAC330-69	BOTTLE PRESSURE TRANSDUCER R134A
25	EEAC330-84	SAFETY VALVE (12BAR)
39	EEAC334-12	SAFETY PRESSURE SWITCH (25 BAR) R134A
41	EEAC334-12	SAFETY PRESSURE SWITCH (25 BAR) R1234YF
59	EEAC330-69	BOTTLE PRESSURE TRANSDUCER R1234YF
62	EEAC334-69 & EEAC330-50	SERVICE TEST CONNECTION R134A
63	EEAC334-69 & EEAC330-50	SERVICE TEST CONNECTION R1234YF























REF#	PART #	DESCRIPTION
EV8	ELT1175	R134A OIL COMPR REFILL ELECTRONIC VALVE
EV8	VLV1175	R134A OIL COMPR REFILL SPOOL VALVE
EV10	ELT1175	OIL DISCHARGE ELECTRONIC VALVE
EV10	VLV1175	OIL DISCHARGE SPOOL VALVE
EV18	ELT1175	R1234YF OIL COMPR REFILL ELECTRONIC VALVE
EV18	VLV1175	R1234YF OIL COMPR REFILL SPOOL VALVE
T5	TUB2146	MANIFOLD EV1 - HP SERVICE HOSE R134A
T6	TUB2132	MANIFOLD EV11 - HP SERVICE HOSE R1234YF
T7	TUB2147	MANIFOLD EV2 - LP SERVICE HOSE R134A
T8	TUB2122	MANIFOLD EV12 - LP SERVICE HOSE R1234YF
T15	TUB1224	MANIFOLD EV7 - 3RD CONNECTION TANK R134A
T16	TUB1224	MANIFOLD EV17 - 3RD CONNECTION TANK R1234YF
T17	TUB1224	MANIFOLD EV8 - COMPRESSOR R134A
T18	TUB1224	MANIFOLD EV18 - COMPRESSOR R1234YF
T23	TUB1250	MANIFOLD EV20 UPPER OUTLET - USED OIL TEE FITTING
T31	TUB1224	MANIFOLD - HP MANOMETER R134A
T32	TUB1224	MANIFOLD - HP MANOMETER R1234YF
T33	TUB1224	MANIFOLD - LP MANOMETER R134A
T34	TUB1224	MANIFOLD - LP MANOMETER R1234YF
T38	TUB1250	MANIFOLD EV10 - USED OIL CONTAINER
15	EEAC330-69	A/C PRESSURE TRANSDUCER R1234YF
18	EEAC330-69	A/C PRESSURE TRANSDUCER R134A
64	EEAC334-71	USED OIL TEE FITTING













REF#	PART #	DESCRIPTION
T2	TUBX129	EV22 - LP HYBRID FITTING R134A
T4	TUBX131-OT	EV23 - LP HYBRID FITTING R1234YF
T24	TUB1258	VACUUM PUMP OUTLET - MANIFOLD EV20 INLET
T25	TUB1175	MANIFOLD EV6 - LIQUID SIDE TANK R134A
T26	TUB1175-YF	MANIFOLD EV16 - LIQUID SIDE TANK R1234YF
T27	TUB1259	MANIFOLD EV3 - EV4 BYPASS
T28	TUB1257	MANIFOLD EV21 NCG PURGE
T37	TUB1259	MANIFOLD EV3 - VACUUM PUMP INLET

PART NUMBER	IMAGE	DESCRIPTION
EEAC330-121		STICKER "SWITCH OFF"
EEAC331-1		STICKER FOR THE PRINTER
ADE6407		STICKER USED OIL
EEAC330-1		STICKER
ADE6514		FRONT PANEL
EEAC330-3		STICKER GLOSSY USED OIL
EEAC330-4		BOTTLE STICKER R134a
EEAC333-1		BOTTLE STICKER HFO
EEAC330-102		WARNING STICKER (EN)
EEAC330-103		WARNING STICKER (FR)
EEAC333-21		FIRE RISK STICKER (EN)
EEAC333-23		FIRE RISK STICKER (FR)
EEAC334-72		FIRE RISK STICKER (EN)
EEAC334-73		FIRE RISK STICKER (FR)
ADE6705		EXTERNAL IGNITION WARNING STICKER
ADE6765		STICKER LOGO ECO DUAL GAS

PART NUMBER	IMAGE	DESCRIPTION
ADE6771		STICKER DX-SX BOTTLE RELEASE
AEK228A		QUICK COUPLER HP F14x1,5 R134a
AEK228B		QUICK COUPLER LP F14x1,5 R134a
AEK229A		QUICK COUPLER HP FOR HFO
AEK229B		QUICK COUPLER LP FOR HFO
EEAC333-5		ADAPTER BOTTLE DUPONT- HONEYWELL LP HFO1234yf
EEAC333-6		ADAPTER BOTTLE HONEYWELL LP HFO1234yf
EEAC330-8		ADAPTER BOTTLE R134a LP
EEAC330-124		50 Kg BOTTLE LOAD CELL AMP MODU MTE CONNECTION
EEAC330-10		15 kg OIL LOAD CELL AMP MODU MTE CONNECTION
EEAC333-36		CONDENSER FAN 12 VDC 172X150X51
EEAC330-11		30 Lb BOTTLE M1/4" SAE HFO-R134a
EEAC330-12		SPACER BOTTLE SCALE PLATE 4MM
CRP3766		POWER CABLE HOOK
CRP3801		REAR POCKET
CRP3803		HANDLE

















PART NUMBER	IMAGE	DESCRIPTION
CRP3856		FRONT POCKET
EEAC330-13		WRENCH PARKER FILTER
EEAC330-100		SPACER BOTTLE SCALE PLATE 10 MM
DIS1348		DRYER FILTER ALLUMINIUM MANIFOLD
ELT1171		BIG COIL ODE BDA 12V.FASTON CONNECTION
ELT1175		SMALL COIL ODE BDA 12V. FASTON CONNECTION
EEAC330-17		POWER SUPPLY CABLE 3,2 MT. USA
EEAC330-19		POWER MAIN SWITCH
EEAC330-20		THERMAL RESIST. 12 Lt BOTTLE 110 V. CRIMP TER. CONNECTION
EEAC331-27		STATUS LIGHT WIRING
EEAC330-21		INTERNAL USB CABLE A TYPE 6 PIN MT.1
EEAC334-78		ANALYZER CABLE 1550 mm DUAL GAS
EEAC331-04		PRINTER WIRING E19 350 M/M
EEAC330-22		CABLE TRS9000-SC AMP MODU MTE CONNECTION
EEAC333-8		FILTER GAS ANALYZER R134a-HFO
EEAC330-23B		FILTER DYER















PART NUMBER	IMAGE	DESCRIPTION
GRCMP20-A		COMPRESSOR for R134a 110V - 60Hz Mate'N Lock
GRCMP06YF- A2		COMPRESSOR for HFO 110V - 60Hz Mate'N Lock
EEAC334-25		CONDENSER
EEAC333-9		CONDENSER
EEAC334-22		USED OIL ROUND BOTTLE 500 cc
EEAC330-28		BRASS CAP F1/4" SAE WITH GASKET
IMB0026		TNT COVER
KIT003		O-RING GASKETS MANIFOLD (NEOPRENE) 2+2
EEAC330-30		HP MANOMETER -1+40 BAR cl1 80 mm DIAM.
EEAC330-31		LP MANOMETER -1+17 Bar cl1 80 mm DIAM.
PLA2521-NA00		REAR PLASTIC COVER BLACK
PLA2522-NA00		TOP PLASTIC COVER BLACK
PLA2543-NA00		FRONTAL PLASTIC COVER BLACK
PLA2600-00		PLASTIC COVER ANALYZER
PLA2603-00		FRAME DISPLAY 7"
PLA2605-00		WITHE LED PLASTIC

PART NUMBER	IMAGE	DESCRIPTION
ACT71-0A		VACUUM PUMP OIL 500 ml. ISO46
EEAC331-13		VACUUM PUMP 6 CFM 110V – 60Hz
EEAC334-12		SAFETY PRESSURE SWITCH 25 BAR TKP CONNECTOR
EEAC330-129		COPPER GASKET 3/8 SAE
RAC0503		SILENT BLOCK 25X15 M6
EEAC334-14		TANK PLATE D13-M3 MAGNET
RAC4100		ALLUMINIUM NUT 1/4" SAE
RAC5217		THREADED LOCKING BOTTLE
RAC5150		R134a LP CONNECTOR WITH DEPRESSOR
EEAC330-50		DEPRESSOR VALVE for RAC5149 and RAC5159
EEAC332-2		DEPRESSOR VALVE
EEAC333-10		HP CONNECTOR HFO
EEAC333-11		LP CONNECTOR HFO
EEAC332-3		HP CONNECTOR R134a
EEAC332-4		LP CONNECTOR R134a
EEAC330-51		CHECK VALVE OIL IN PLACE OF RAC5700- RAC5701

PART NUMBER	IMAGE	DESCRIPTION
EEAC330-97		NIPPLE M1/8"G. M3/8"SAE
EEAC330-93		NIPPLE M1/8"G.M1/4"SAE
EEAC333-27		R134a NIPPLE 1/8 GAS 1/2 ACME
EEAC330-54		DOUBLE REVOLVING PIPE UNION F1/4"- F1/4" SAE
EEAC330-56		REFERENCE WHEIGHT BALL 30 mm 112G.
RAC6521		CYLINDER BLOCK KNOB
RAC6526		CYLINDER STOP WEDGE
RAC6527		COTTER PIN ELASTIC
EEAC333-28		R1234yf FITTING M1/8 G.-F12X1,5
EEAC334-71		USED OIL TEE FITTING 6/4 M1/8"
EEAC334-52		FITTING 1/4 "SAE-1/4" SAE
RAC8099-OT		FITTING M24-1/8G
RAC8103		TEE M-M 1/4"SAE F.1/4" SAE
EEAC334-48		ELBOW FITTING 6mm 1/8gas
EEAC330-106		ELBOW FITTING 10mm 3/8gas
RUO7071		FRONT WHEEL WITH BRAKE 125mm

PART NUMBER	IMAGE	DESCRIPTION
RUO7121		REAR WHEEL 300 mm
RUO7401		RING STOPPER WHEEL HOLE 20 M/M FOR RU-O7140
EEAC330B-11		ANTENNA PCB WI FI
EEAC330B-12		POWER SUPPLY
SCH1910		MOTHERBOARD UI NEW RANGE
SCH5012 or SCH5012RT		DISPLAY TFT 7"
EEAC331-18		LED CARD
EEAC330-66		TEMPERATURE PROBE NTC 10k
EEAC333-8		O2 SENSOR FOR GAS ANALAYZER
GRSTM0007D		THERMAL PRINTER
EEAC331-20		THERMAL PAPER BOX 10PC.
EEAC330-67		CAP FOR WHEEL RUO7121
EEAC330-68		CABLE GUIDE
EEAC330-69		PRESSURE TRASDUCER 2CP5-64
EEAC330-73		BLUE HOSE 90 cm F1/4" - F1/4" SAE WITH BALL VALVE
EEAC330-74		RED HOSE 90 cm F1/4" - F1/4" SAE WITH BALL VALVE

PART NUMBER	IMAGE	DESCRIPTION
EEAC330-89		COPPER HOSE 1 MT. F1/4" - F1/4" SAE
EEAC330-90		COPPER HOSE 500 mm F1/4"-F1/4" SAE
EEAC330-75		SILICON TUBE 10 MT MM 3X6 X OIL
EEAC330-76		PA12 HOSE 2,5X4
EEAC330-77		PA12 HOSE 4X6
EEAC330-78		PA12 HOSE 8X10
EEAC333-16		ANALYZER TUBE WITH PRESSURE REDUCER HFO
TUB2122		RED HOSE 3 m HFO-1234yf m/m 12x1,5
TUB2132		BLUE HOSE 3 m HFO-1234yf m/m 12x1,5
TUB2146		RED HOSE 3m R134a F1/2" ACME M14X1.5
TUB2147		BLUE HOSE 3m R134a F1/2" ACME M14X1.5
TUBX128		COPPER HOSE T1 EV22 HY-HP-134 (BRASS FITTING)
TUBX129		COPPER HOSE T1 EV22 HY-LP-134 (BRASS FITTING)
TUBX130-OT		COPPER HOSE T3 EV23 HYB-HP-YF (BRASS FITTING)
TUBX131-OT		COPPER HOSE T1 EV23 HY-LP-YF (BRASS FITTING)
TUBX132		COPPER HOSE T9 EVAP-COND. (BRASS FITTING)

PART NUMBER	IMAGE	DESCRIPTION
TUBX133-AI		STAINLESS STEEL TUBE T10 EVAP-COND.
TUBX134		COPPER HOSE T11 COMP.-SEP.134 (BRASS FITTING)
TUBX135-AI		STAINLESS STEEL TUBE T12 EVAP-COND.-YF
TUBX136		COPPER HOSE T19 CK2-COMPR.-134 (BRASS FITTING)
TUBX137-OT		COPPER HOSE T20 CK5 COMPR.-YF (BRASS FITTING)
TUBX138		COPPER HOSE T21 EV9 FILTER 134 (BRASS FITTING)
TUBX139-OT		COPPER HOSE T22 EV19 FILTER YF (BRASS FITTING)
VLV1170		SOLENOID VALVE ODE 12 V.
VLV1175		SOLENOID VALVE ODE 12 V.
VLV1451-N		CHECK VALVE B04 ODE
EEAC330-82		CHECK VALVE M1/4"- M1/4" SAE
EEAC330-83		CHECK VALVE M3/8"- M3/8" SAE
EEAC330-85		SAFETY VALVE 1/8" G. 1bar
EEAC334-21		GAS ANALYZER R134a-HFO-1234yf

PARTS MANUAL



SIMPLY EFFICIENT

ECO DUAL GAS

IDSC HOLDINGS LLC.

2801 80TH STREET

KENOSHA, WI. 53143-5656

Notice: The information contained in this document is subject to change without notice. Snap-on Equipment makes no warranty with regard to this material. Snap-on Equipment shall not be liable for errors contained herein or for incidental consequential damages in connection with furnishings, performance, or use of this material.

This document contains proprietary information which is protected by copyright and patents. All rights are reserved. no part of this document may be photocopied, reproduced, or translated without prior written consent

For Parts And Service Call Snap-on Equipment 1.800.225.5786