

PARTS MANUAL

ECOTECHNICS

ECO NEXT ONE



EEAC830B

**R1234yf Refrigerant
Recovery / Recycle / Recharge
Service Vehicle A/C System**

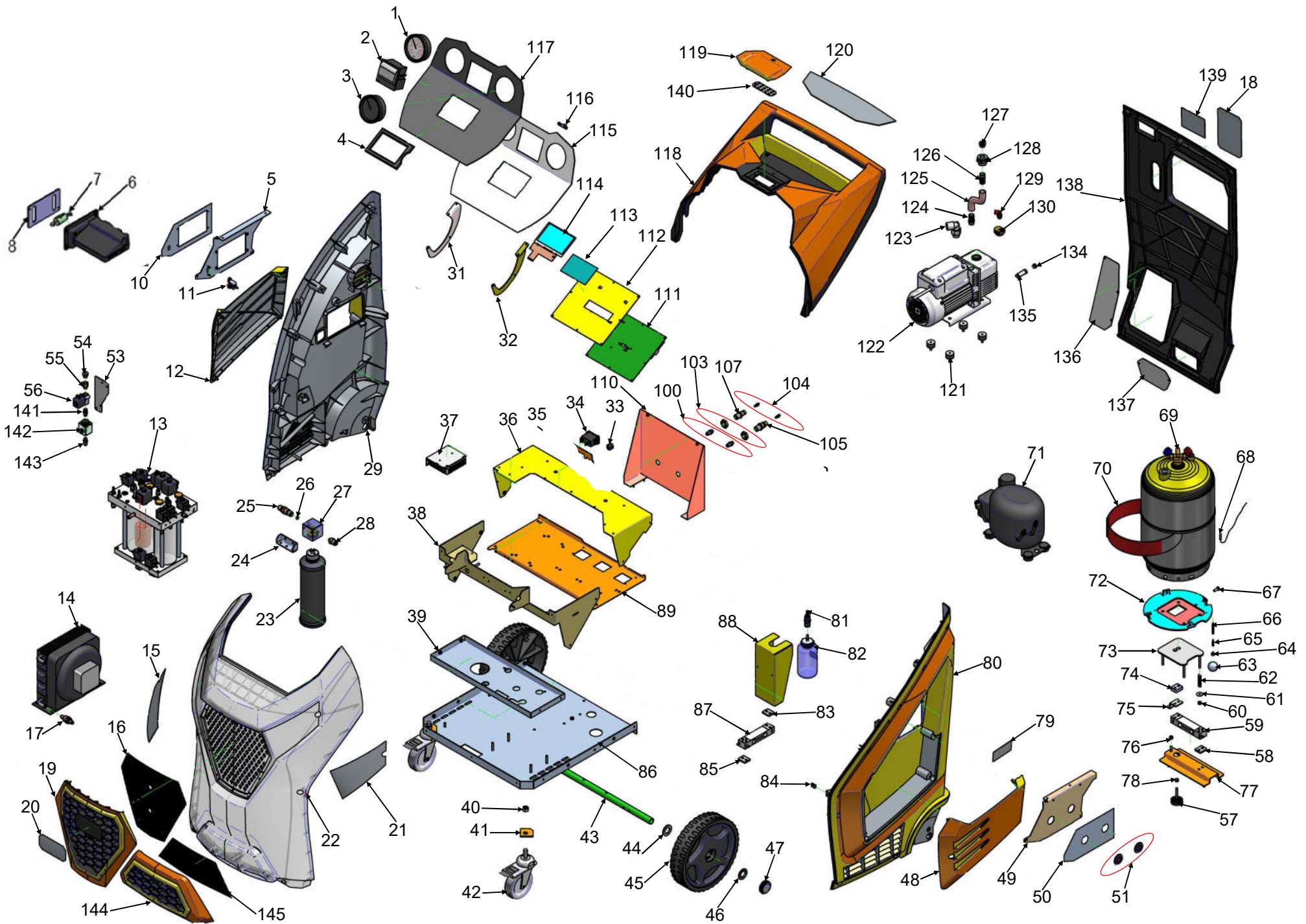

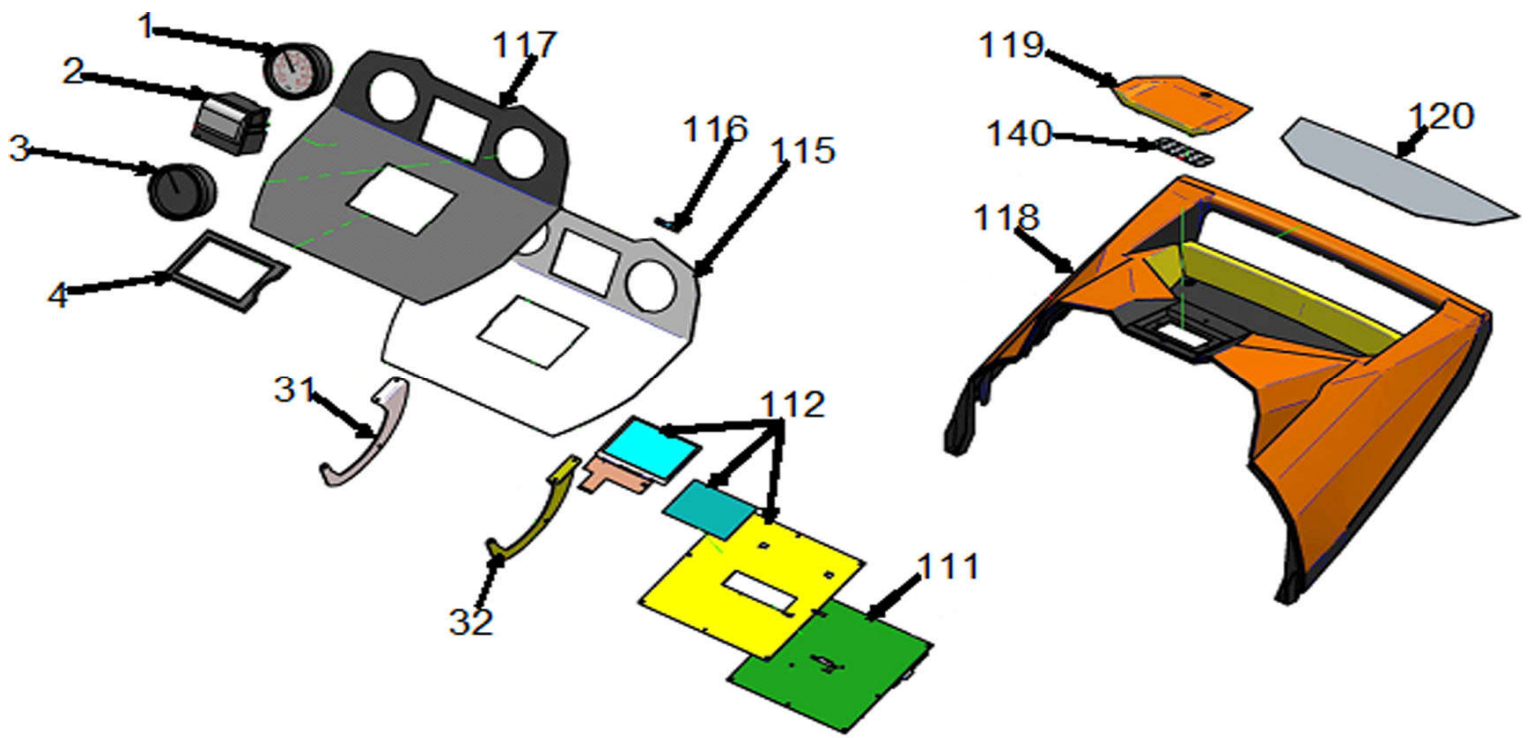

REF#	PART NUMBER	DESCRIPTION
1	EEAC330-30	HIGH PRESSURE GAUGE-MAN3160
2	GRSTM0007D	THERMAL PRINTER
3	EEAC330-31	LP GAUGE D.80-1+17 BAR/PSI
4	EEAC330-44	5" DISPLAY PLASTIC FRAME
31	CRP5127	LEFT HINGE SUPPORT BRACKET
32	CRP5116	RIGHT HINGE SUPPORT BRACKET
111	SCH1961	MOTHERBOARD
112	GRSCH1350-NA	DISPLAY W/ SUPPORT BRACKET
115	CRP5255	COMMAND PANEL BRACKET
116	CRP5113	COMMAND PANEL FIXING BRACKET
117	ADE6768	COMMAND PANEL STICKER
118	PLA2594-01	TOP PLASTIC COVER
119	PLA2595-03	TOP PLASTIC LED COVER
120	GUA0064	TOOL TRAY MAT
140	EEAC331-18	LED LIGHT MOTHERBOARD

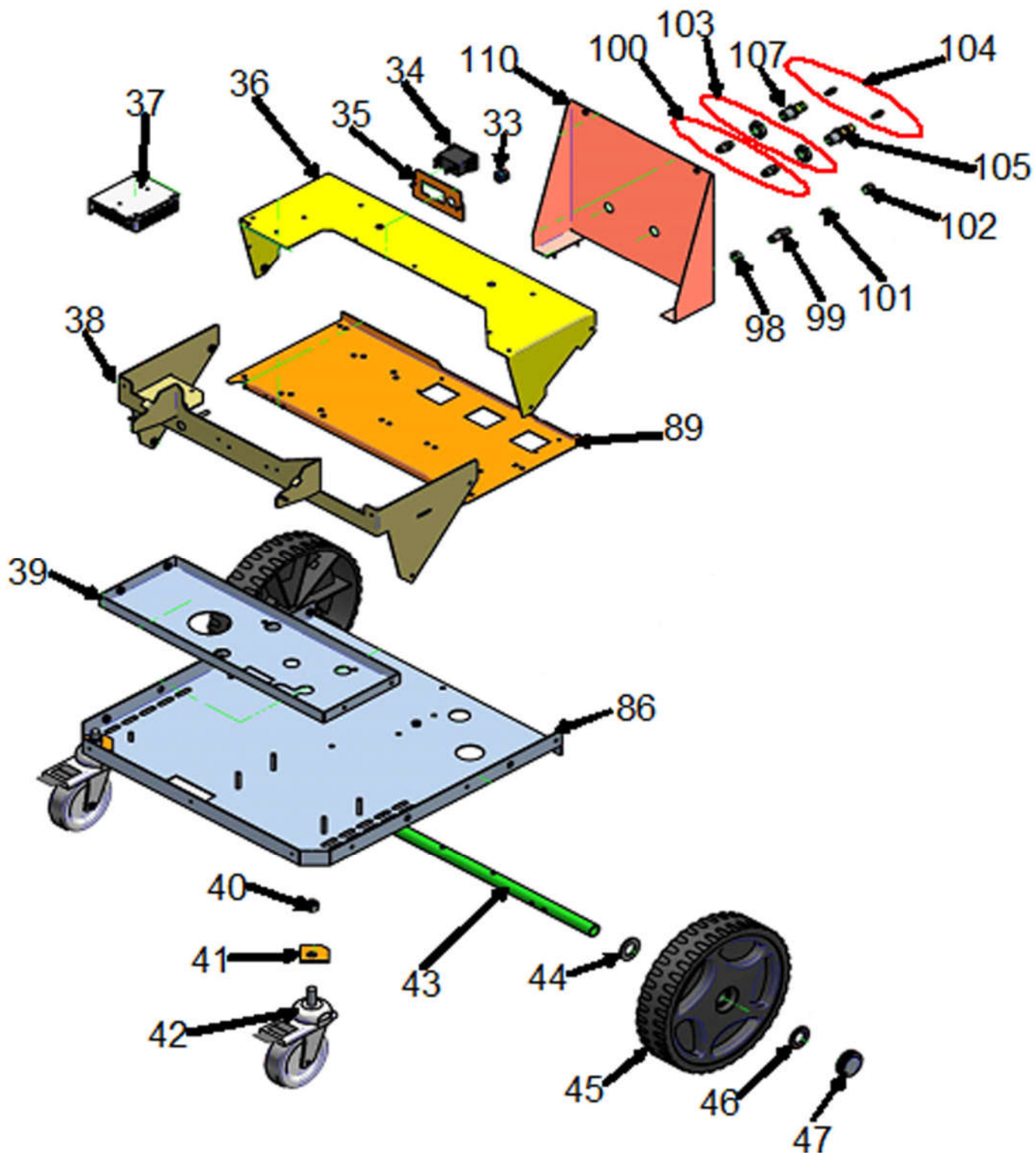

REF#	PART NUMBER	DESCRIPTION
33	EEAC330-18	CABLE GUIDE
34	EEAC330-19	MAIN SWITCH
35	CRP5188	MAIN SWITCH SUPPORT BRACKET
36	CRP5187	HANDLE SHEET METAL BRACKET
37	EEAC330B-12	POWER SUPPLY LRS-50-12 AC/DC
38	CRP5112	HINGE SUPPORT SHEET METAL
39	CRP5115	MANIFOLD SUPPORT BRACKET
40	VIT0038	M12 LOCKNUT
41	CRP3625	FRONT WHEEL SPACER
42	RUO7070	FRONT WHEEL
43	CRP5102	REAR WHEEL AXIS
44	VIT0060	REAR WHEEL SPACER
45	RUO7140	REAR WHEEL
46	EEAC330-61	REAR WHEEL RETAINER
47	EEAC330-67	REAR WHEEL CAP
89	CRP5126	PUMP SUPPORT SHEET METAL
98	RAC4100	1/4SAE NUT
99	EEAC334-52	NIPPLE 1/4SAE
100	EEAC330-93	NIPPLE 1/8GAS - 1/4SAE
101	EEAC330-50	SCHRADER VALVE V2999
102	EEAC330-28	1/4SAE THREATED CAP
103	VIT0028	M16 NUT
104	EEAC332-2	SCHRADER VALVE V2994
105	EEAC333-10	HP HYBRID QUICK FITTING
106	EEEAC332-2	SCHRADER VALVE V2994
107	EEAC333-11	LP HYBRID QUICK FITTING

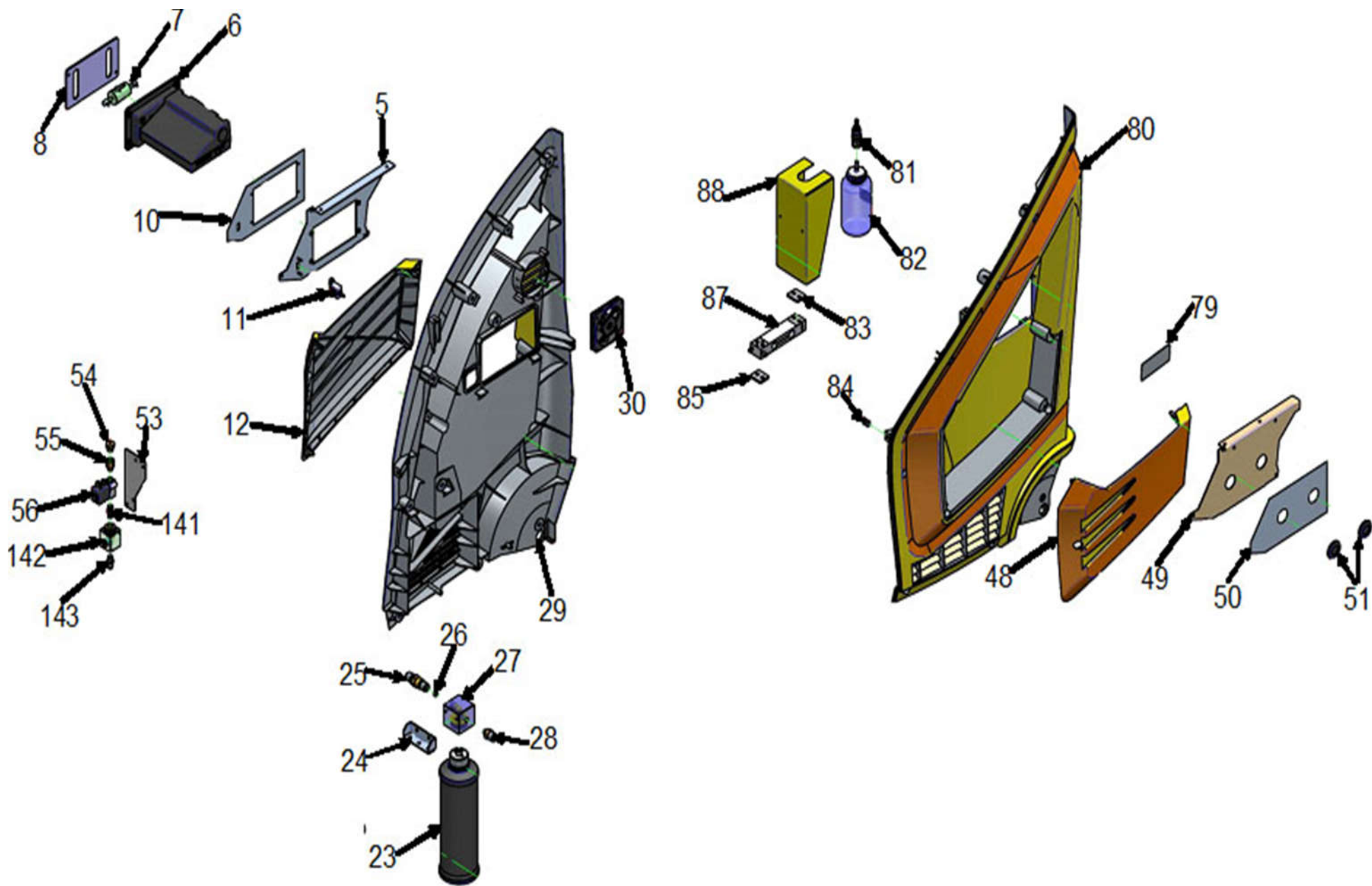

REF#	PART NUMBER	DESCRIPTION
5	N/A	LEFT SIDE BRACKET
6	EEAC333-18	GAS ANALYZER
7	EEAC333-8	GAS ANALYZER FILTER
8	PLA2600-00	GAS ANALYZER FILTER SCREEN PROTECTION
10	ADE6713	LEFT SIDE STICKER
11	EEAC330-21	USB WIRED CONNECTION
12	PLA2602-06V0	LEFT SIDE PLASTIC POCKET RAL7001
23	EEAC330-23B	DRYER FILTER
24	CRP4137	FILTER SUPPORT BRACKET
25	EEAC330-83	CHECK VALVE NRV 10
26	EEAC334-41	1/8GAS FILTER FITTING
27	EEAC330-96	DRYER FILTER ALUMINUM CONNECTION
28	EEAC330-97	NIPPLE FITTING 1-8GAS - 3-8SAE
29	PLA2591-01	LEFT SIDE PLASTIC
30	CND0009	FAN VDR 8015L1
48	PLA2601-06V0	RIGHT SIDE PLASTIC POCKET RAL7001
49	CRP5257	RIGHT SIDE BRACKET
50	ADE6816	RIGHT SIDE STICKER
51	EEAC330-68	RUBBER BULKHEAD
53	CRP5258	GAS ANALYZER ELECTRONIC VALVE SUPPORT BRACKET
54	RAC5191	GAS ANALYZER PRESSURE REDUCER
55	EEAC333-28	FITTING M1-8GAS F12X1.5
56	VLV1461-N-E	GAS ANALYZER ELECTRONIC VALVE
79	ADE6719B	REFRIGERANT LABEL
80	PLA2589-01	RIGHT SIDE PLASTIC
81	EEAC330-57	USED OIL QUICK FITTING
82	EEAC330-27	USED OIL CONTAINER
83	EEAC330-12	LOAD CELL 4MM SPACER
84	RAC8110	U-CLIP
85	EEAC330-12	LOAD CELL 4MM SPACER
141	EEAC330-170	NIPPLE 1/8GAS 1/8GAS
142	GRDIS1343	GAS ANALYZER INLET FILTER MANIFOLD
143	EEAC330-93	NIPPLE 1/8GAS 1/4SAE

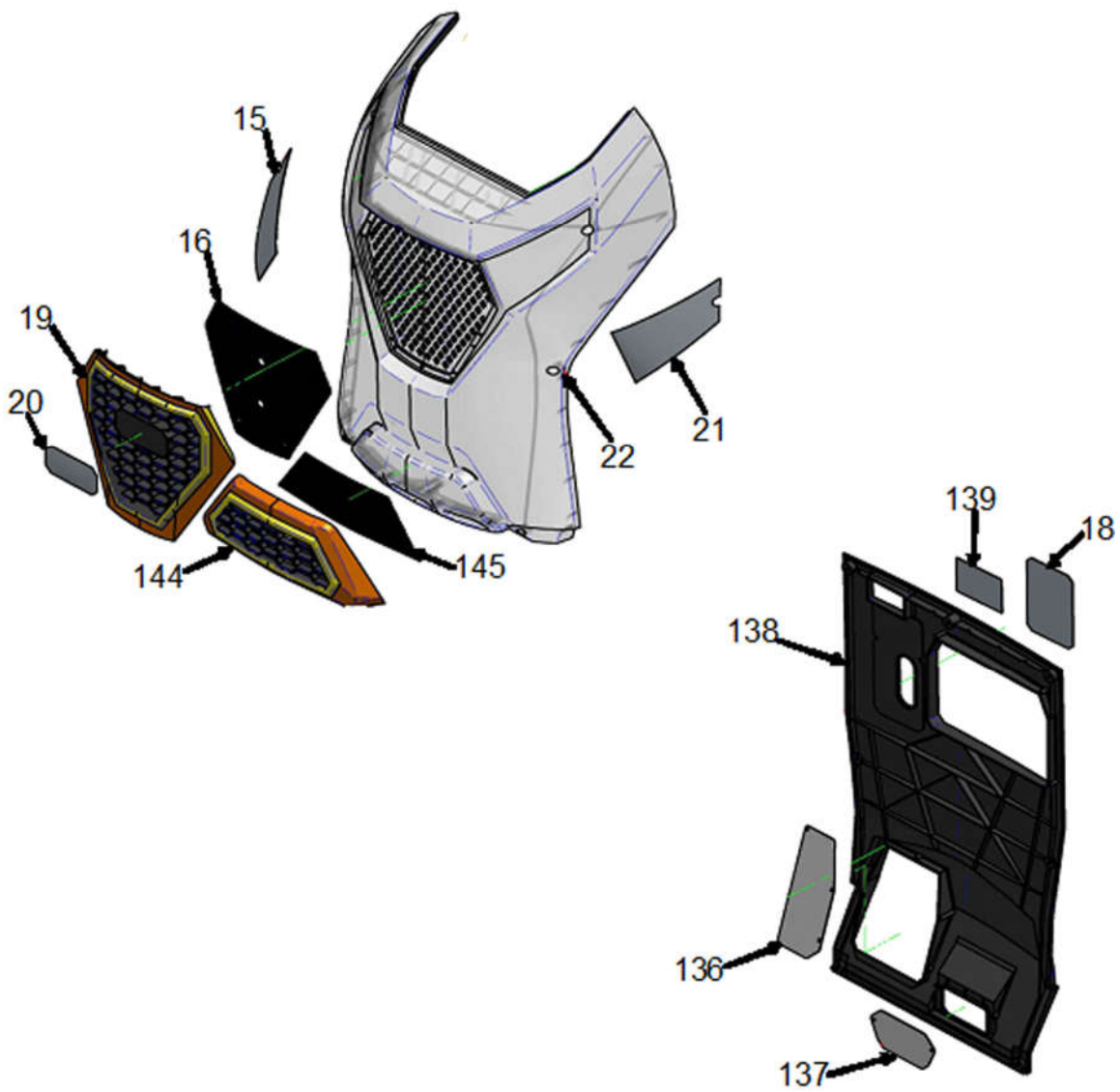

REF#	PART NUMBER	DESCRIPTION
15	ADE6827	FRONT LEFT STICKER
16	RAC8111	FRONT ALUMINUM GRID
18	ADE6714	VACUUM PUMP STICKER
19	PLA2598-02	PLASTIC GRID
20	ADE6819	FRONT GLAZED STICKER
21	ADE6826	FRONT RIGHT STICKER
22	PLA2587-06	FRONT PLASTIC COVER RAL7001
136	CRP5103	REAR USED OIL SHEET METAL
137	CRP5131	REAR SHEETMETAL PLUG
138	PLA2593-01	REAR PLASTIC COVER

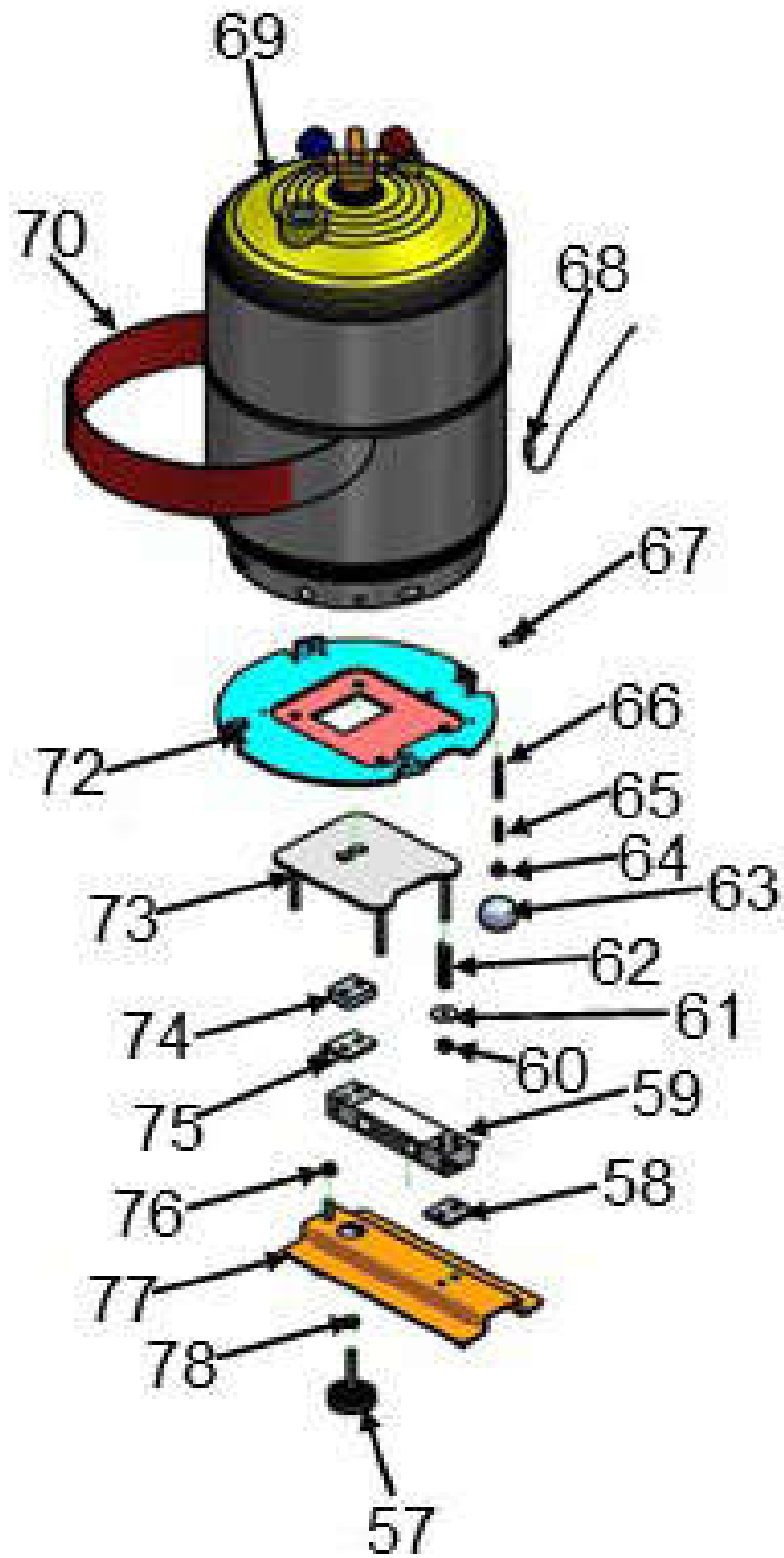

REF#	PART NUMBER	DESCRIPTION
57	RAC8118	REFRIGERANT TANK LOAD CELL LOCK KNOB
58	EEAC330-12	LOAD CELL 4MM SPACER
59	EEAC330-124	LOAD CELL 50 KG
60	VIT0003	M6 LOCKNUT
61	VIT0020	WASHER
62	EEAC334-56	COMPRESSION SPRING
63	EEAC330-56	TANK LOAD CELL REFERENCE WEIGHT
64	EEAC330-94	REFERENCE WEIGHT MAGNET
65	RAC6102	SPACER M3X17MM
66	RAC6118	SPACER M3X30MM
67	VIT0013	BOLT M6X16
68	EEAC330-66	REFRIGERANT TANK TEMPERATURE SENSOR
69	EEAC330-11	REFRIGERANT TANK 30LB
70	EEAC330B-2	REFRIGERANT TANK HEATER
71	EEAC333B-4	COMPRESSOR
72	CRP5172	REFRIGERANT TANK SUPPORT PLATE
73	CRP5054	SUPPORT DAMPEN PLATE
74	EEAC330-100	LOAD CELL 10MM SPACER
75	CRP5173	REFRIG. BOTTLE LOAD CELL LOCK BRACKET
77	CRP5171	TANK LOAD CELL REINFORCEMENT
78	VIT0003	M6 LOCKNUT
N/S	ADE6719B	REFRIGERANT LABEL

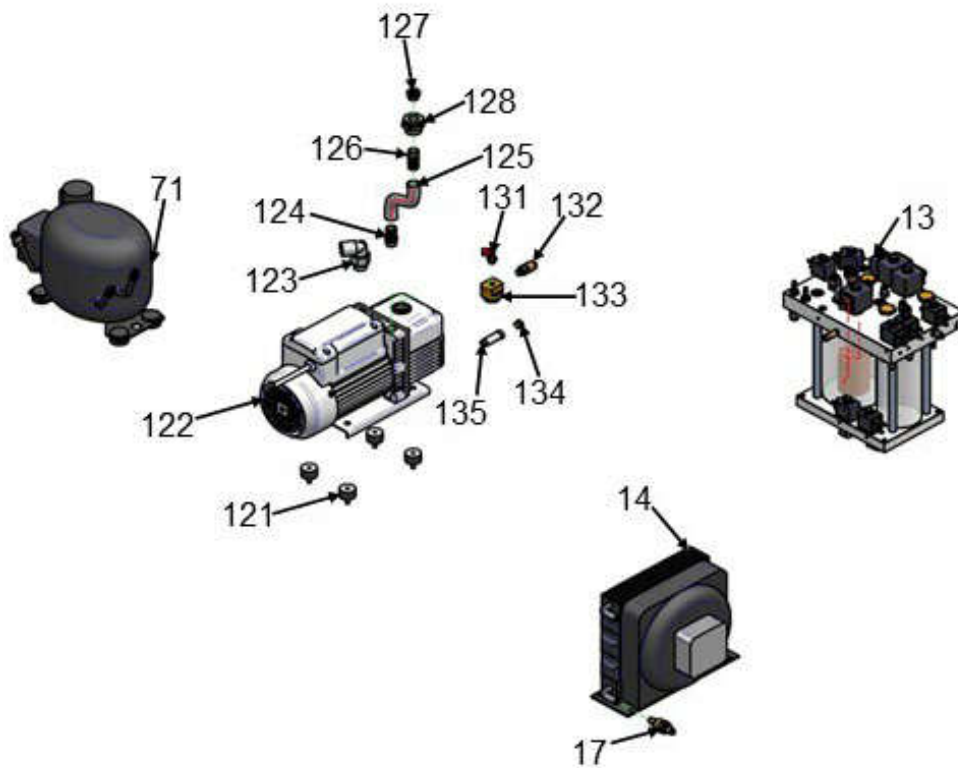



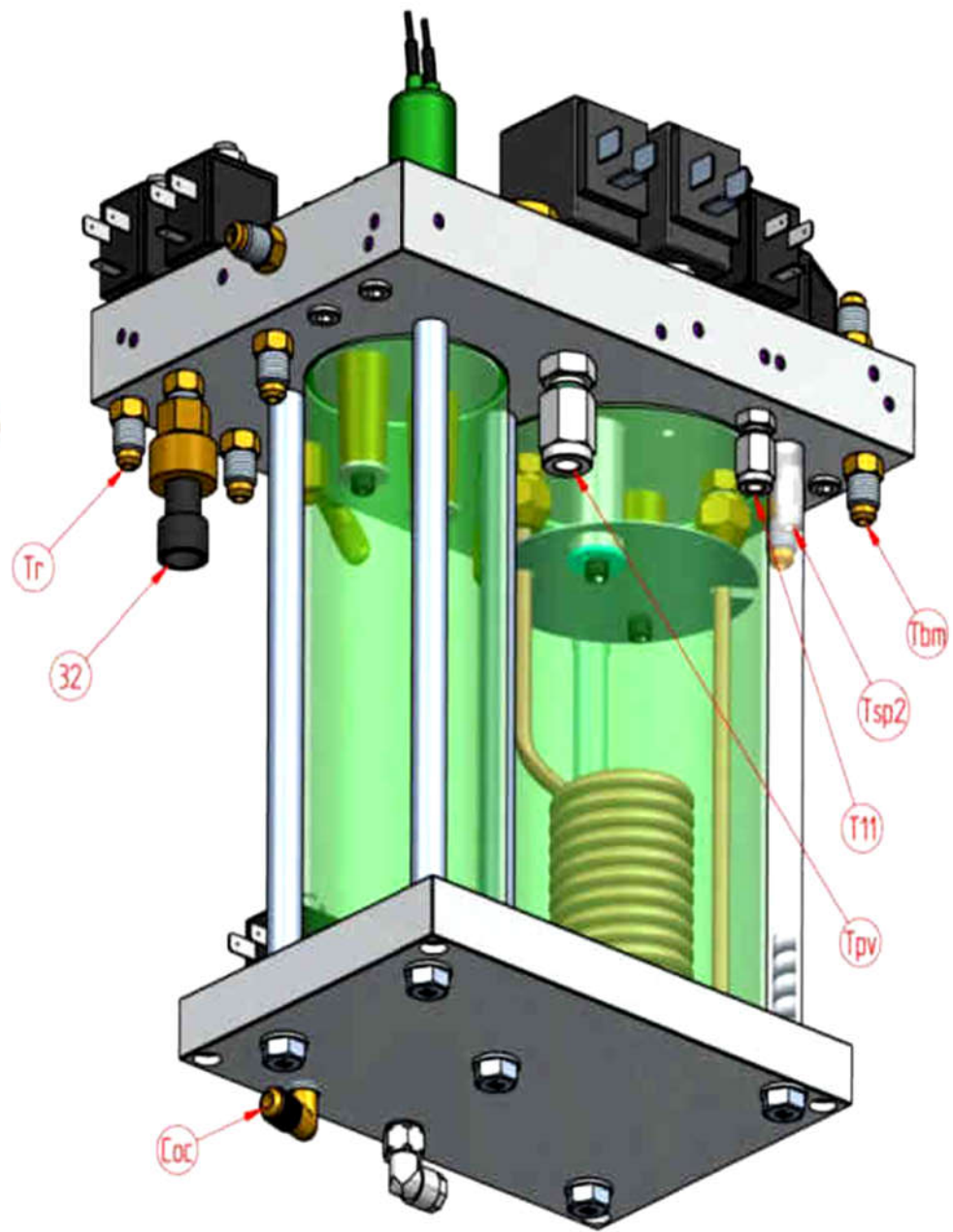
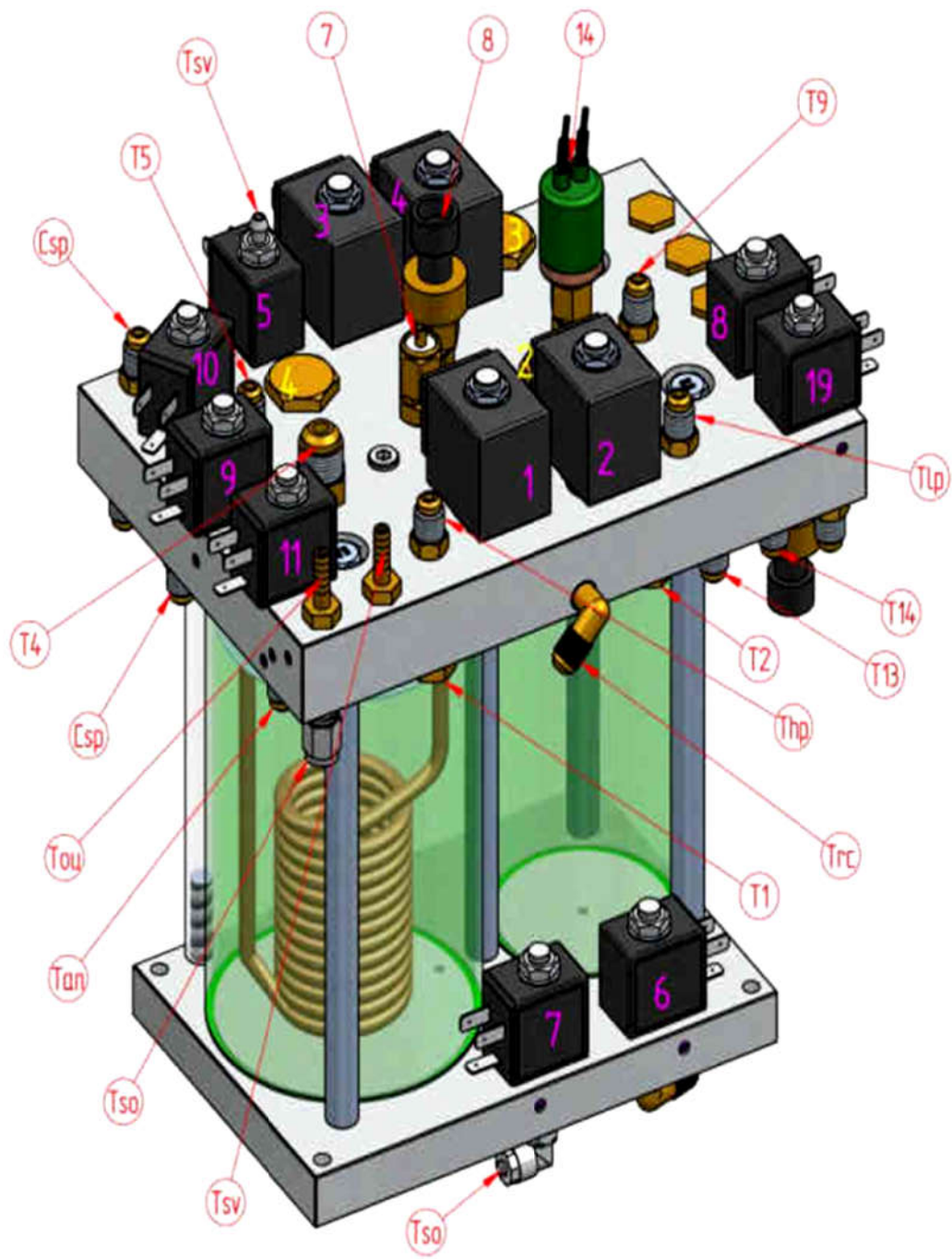









REF#	PART NUMBER	DESCRIPTION
13	EEAC333B-1	MANIFOLD
14	GRCND12YF-A	CONDENSER
17	EEAC330-82	CHECK VALVE NRV 6
71	EEAC333B-4	COMPRESSOR
121	RAC0503	ANTIVIBRATION FOOT
122	PMP3964	VACUUM PUMP
123	EEAC330-106	10MM ELBOW 3/8 FITTING
124	EEAC334-43	HOSE FITTING 16MM
125	EEAC334-44	OIL PUMP FILLING HOSE
126	EEAC334-45	HOSE FITTING 16MM
127	EEAC334-46	OIL PUMP FILLING CAP
128	EEAC334-47	MOUNT ADAPTER FITTING
131	EEAC334-48	6MM ELBOW 1/8 FITTING
132	EEAC330-85	SAFETY VALVE 1BAR
133	RAC8099-OT	ADAPTER FITTING M24X1.5 1/8 GAS
134	EEAC334-49	OIL DRAIN CAP
135	EEAC330-116	OIL DRAIN EXTENSION



REF#	PART NUMBER	DESCRIPTION
T1	EEAC331-21	HIGH PRESSURE FITTING-EV1
T2	EEAC331-22	LOW PRESSURE FITTING-EV2
T4	TUBX085	EVAPORATOR-FILTER
T5	TUBX086	MANIFOLD HEATER-CONDENSER
T9	EEAC330-127	COMPRESSOR-OIL SEPARATOR
T10	EEAC330-114	CK1-COMPRESSOR
T11	EEAC330-77	PUMP-EV5 (TUB1258)
T13	TUBX067	EV19-HP MALE COUPLING
T14	TUBX068	EV19-LP MALE COUPLING
TSO	EEAC330-77	OIL DISCHARGE BYPASS (TUB1258)
CSP	EEAC330-90	AIR PURGE BYPASS (TUB1226)
TB	EEAC330-73	COND-REFRIG BOTTLE (LP SIDE) (TUB1174)
TR	EEAC330-74	REFRIG BOTTLE (HP SIDE-MANIFOLD) (TUB1175)
TPV	EEAC330-78	EV4-VACUUM PUMP (TUB1259)
TSV	EEAC330-75	VACUUM PUMP DISCHARGE (TUB1250)
TOU	EEAC330-75	MANIFOLD-USED OIL CONTAINER (TUB1250)
COC	EEAC330-89	EV6-COMPRESSOR (TUB1224)
TBM	EEAC330-89	TANK 3RD CONNECTION - EV9 (TUB1224)
TLP	EEAC330-89	MANIFOLD-LP MANOMETER (TUB1224)
THP	EEAC330-89	MANIFOLD-HP MANOMETER (TUB1224)
TRC	EEAC330-89	MANIFOLD-CONTAMINATED REFRIGERANT FITTING
TAN	EEAC330-89	EV11-GAS ANALYZER
EV1	ELT1171	EV1 HIGH PRESSURE SOLENOID
EV1A	VLV1170	EV1 HIGH PRESSURE SPOOL VALVE
EV2	ELT1171	EV2 LOW PRESSURE SOLENOID
EV2A	VLV1170	EV2 LOW PRESSURE SPOOL VALVE

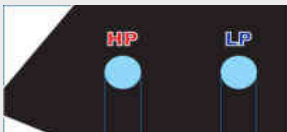







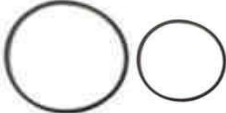

REF#	PART NUMBER	DESCRIPTION
EV3	ELT1171	EV3 OUTLET EVAPORATOR SOLENOID
EV3A	VLV1170	EV3 OUTLET EVAPORATOR SPOOL VALVE
EV4	ELT1171	INLET VACUUM SOLENOID
EV4A	VLV1170	INLET VACUUM SPOOL VALVE
EV5	ELT1175	EV5 OUTLET VACUUM SOLENOID
EV5A	VLV1177	EV5 OUTLET VACUUM SPOOL VALVE
EV6	ELT1175	EV6 OIL COMPRESSOR REFILL SOLENOID
EV6A	VLV1175	EV6 OIL COMPRESSOR REFILL SPOOL VALVE
EV7	ELT1175	OIL DISCHARGE ELECTRONIC SOLENOID
EV7A	VLV1175	OIL DISCHARGE ELECTRONIC SPOOL VALVE
EV8	ELT1175	EV8 REFILLING ELECTRONIC SOLENOID
EV8A	VLV1175	EV8 REFILLING ELECTRONIC SPOOL VALVE
EV9	ELT1175	EV9 EVAP OVERPRESSURE ELECTRONIC
EV9A	VLV1175	EV9 EVAP OVERPRESSURE ELECTRONIC SPOOL
EV10	ELT1175	EV10 AIR PURGE SOLENIOD
EV10A	VLV1175	EV10 AIR PURGE SPOOL VALVE
EV19	ELT1175	EV19 WASHING PIPES (HYBRID) SOLENIOD
EV19A	VLV1175	EV19 WASHING PIPES (HYBRID) SPOOL VALVE
7	EEAC330-84	SAFETY VALVE (12BAR) (VLV2102
8	EEAC330-69	A/C PRESSURE TRANSDUCER (TRS9000-SC)
14	EEAC334-12	SAFE PRESSURE SWITCH (20 BAR) (PRS4326-E)
32	EEAC330-69	BOTTLE PRESSURE TRANSDUCER (TRS9000-SC)

PART NUMBER	IMAGE	DESCRIPTION
EEAC331-1		STICKER FORTHE PRINTER
ADE6468		STICKER WARNING VDA
EEAC330-3		STICKER GLOSSY USED OIL
EEAC333-1		BOTTLE STICKER HFO
EEAC330-102		WARNING STICKER (EN)
EEAC330-103		WARNING STICKER (FR)
EEAC333-21		FIRE RISK STICKER (EN)
EEAC333-22		FIRE RISK STICKER (EN)
EEAC333-23		FIRE RISK STICKER (FR)
EEAC333-24		FIRE RISK STICKER (FR)
ADE6811		STICKER RIGHT SIDE
ADE6713		STICKER LEFT SIDE

PART NUMBER	IMAGE	DESCRIPTION
ADE6714		STICKER VACUUM PUMP
ADE6819		STICKER GLOSSY
ADE6719B		REFRIGERANT PLATE HFO
ADE6766		STICKER GLOSSY HYBRID
ADE6767		STICKER GLOSSY HYBRID
ADE6768		FRONT PANEL
ADE6772		STICKER TANK CELL CHECK
ADE6826		STICKER LOGO NEXT ONE DX
ADE6827		STICKER LOGO NEXT ONE SX
AEK229B		QUICK COUPLER LP FOR HFO
AEK229A		QUICK COUPLER HP FOR HFO
EEAC333-5		ADAPTER BOTTLE DUPONT LP HFO1234yf
EEAC33-6		ADAPTER BOTTLE HONEYWELL HFO1234yf

PART NUMBER	IMAGE	DESCRIPTION
EEAC330-124		50 Kg BOTTLE LOAD CELL
EEAC330-10		15 Kg OIL LOAD CELL
CND0009		FAN WITH MPULSE READER 12 VDC 80X80X15
EEAC330-11		30 LB BOTTLE M1/4" SAE
EEAC330-12		SPACER BOTTLE SCALE PLATE 4MM
EEAC330-13		WRENCH PARKER FILTER
EEAC330-100		SPACER BOTTLE SCALE PLATE 10 MM
EEAC330-96		DRYER FILTER ALLUMINIUM MANIFOLD
ELT1171		BIG COIL ODE BDA 12V.
ELT1175		SMALL COIL ODE BDA 12V.
EEAC330-17		POWER SUPPLY CABLE 3,2 MT. USA
EEAC330-19		POWER MAIN SWITCH
EEAC330-20		HEATER BLANKET 110V.

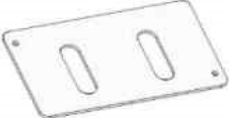
PART NUMBER	IMAGE	DESCRIPTION
EEAC333-30		ANALYZER CABLE
EEAC331-27		STATUS LIGHT WIRING
EEAC330-21		INTERNAL USB CABLE A TYPE
EEAC331-4		PRINTER WIRING E19 350 M/M
EEAC330-22		TRS9000-SC AMP
EEAC333-8		FILTER GAS ANALYZER R134a-HFO
EEAC330-23B		FILTER DYER
GRCMP06YF- A2		COMPRESSOR FOR HFO 110V - 60HZ
GRCND12YF- A		CONDENSER ELECTRICAL FAN 110V - 60HZ
EEAC330-27		USED OIL BOTTLE 250 CC
EEAC330-28		BRASS CAP F1/4" SAE WITH GASKET
GUA0064		CARPET TOOLTRAY
IMB0011		COVER ECK

PART NUMBER	IMAGE	DESCRIPTION
EEAC330-44		FRAME DISPLAY 5"
KIT003		O-RING GASKETS MANIFOLD (NEOPRENE) 2+2
EEAC330-30		HP MANOMETER -1+40 BAR 80 MM DIAM
EEAC330-31		LP MANOMETER -1+17 BAR 80 MM DIAM
PLA2588-02		PLASTIC FRONT GRID
PLA2589-02		RS SIDE PLASTIC COVER
PLA2587-06		FRONT PLASTIC COVER
PLA2599-02		PLASTIC FRONT BUMPER
PLA2591-02		LS SIDE PLASTIC COVER
PLA2593-02		REAR PLASTIC COVER
PLA2600-00		PLASTIC COVER ANALYZER
PLA2594-02		TOP PLASTIC COVER
PLA2595-03		LED PLASTIC COVER













PART NUMBER	IMAGE	DESCRIPTION
PLA2598-02		PLASTIC FRONT GRID
PLA2210		BLACK KNOB
PLA2211		BLUE CAP
PLA2212		RED CAP
PLA2601-06V0		RS PLASTIC POCKET
PLA2602-06V0		LS PLASTIC POCKET RAL
ACT-71A		VACUUM PUMP OIL 1QT. ISO46
PMP3964		VACUUM PUMP 3,5 CFM 110V - 60HZ
EEAC334-12		SAFETY PRESSURE SWITCH 25 BAR
EEAC330-129		COPPER GASKET 3/8 SAE
RAC0503		ISOLATOR BLOCK 25X15 M6
EEAC334-14		TANK PLATE MAGNET
RAC4100		ALLUMINIUM NUT 1/4" SAE







PART NUMBER	IMAGE	DESCRIPTION
EEAC330-50		DEPRESSOR VALVE FOR RAC5149 / RAC5159
EEAC332-2		DEPRESSOR VALVE
EEAC333-10		HP CONNECTOR HFO
EEAC333-11		HP CONNECTOR HFO
EEAC330-51		OIL CHECK VALVE
EEAC330-97		NIPPLE M1/8"G. M3/8"SAE
EEAC334-47		OIL ADAPTER FITTING F 3/8"
EEAC330-93		NIPPLE M1/8"G.M1/4"SAE
EEAC330-54		DOUBLE PIPE UNION F1/4"- F1/4" SAE
EEAC330-56		REFERENCE WHEIGHT BALL 30 MM 112G
RAC8006		OIL FILLING CAP 3/8" G
EEAC333-28		R1234YF FITTING M1/8 G.-F12X1,5
EEAC334-15		OIL FITTING 16MM

PART NUMBER	IMAGE	DESCRIPTION
EEAC330-52		TAP WITH FLANGE 1/4 SAE -1/2 ACME HP-LP
EEAC330-53		TAP WITH FLANGE 1/4 SAE -1/2 ACME HP-LP
EEAC334-49		OIL DRAIN CAP M 1/8"
EEAC334-71		USED OIL TEE FITTING 6/4 M1/8"
EEAC330-116		OIL DRAIN EXTENSION M/F 1/8" L42
EEAC334-52		FITTING 1/4 "SAE-1/4" SAE
EEAC330-57		SOCKET RED BUTTON OIL DRAIN
RAC8099-OT		FITTING M24-1/8G
RAC8103		TEE M-M 1/4"SAE F.1/4" SAE
RAC8111		FRONT GRID
RAC8112		CYLINDER BLOCK KNOB
EEAC334-48		ELBOW FITTING 6MM 1/8GAS
EEAC330-106		ELBOW FITTING 10MM 3/8GAS

PART NUMBER	IMAGE	DESCRIPTION
RAC8116		BUMPER GRID
RUO7070		FRONT WHEEL WITH BRAKE 100 M/M
RUO7140		REAR WHELL 250 M/M
RUO7401		RING STOPPER WHEEL 20 M/M FOR RUO7140
EEAC330B-12		POWER SUPPLY
GRSCH5012 GRSCH5012 RT		DISPLAY 5" TFT
EEAC330B-14		MOTHERBOARD NEVO PLUS
EEAC331-18		LED LIGHT
EEAC330-66		TEMPERATURE PROBE NTC 10K
EEAC333-35		O2 SENSOR FOR GAS ANALAYZER
GRSTM0007D		THERMAL PRINTER
EEAC331-20		THERMAL PAPER BOX 10PC.
TAP5420		CAP F1/2" ACME WITH O RING

PART NUMBER	IMAGE	DESCRIPTION
EEAC330B-7		ANTENNA PCB WI FI
EEAC330-67		CAP FOR WHEEL
EEAC330-68		CABLE GUIDE
EEAC330-69		PRESSURE TRASDUCER
EEAC334-44		OILPUMP FILLING HOSE
EEAC330-72		BLUE HOSE 90 CM F1/4" - F1/4" SAE WITH BALL VALVE
EEAC330-74		RED HOSE 90 CM F1/4" - F1/4" SAE WITH BALL VALVE
EEAC330-89		100CM COPPER HOSE BRASS FITTING DI2MM DE3MM F1/4"-F1/4"SAE
EEAC330-90		0CM COPPER HOSE BRASS FITTING DI1.62MM DE2.8MM F1/4"-F1/4"SAE
EEAC330-91		50CM COPPER HOSE BRASS FITTING DI0.7MM DE1.9MM F1/4"-F1/4"SAE
EEAC330-76		SILICON TUBE 10 MT MM 3X6 OIL
EEAC330-77		PA12 HOSE 4X6
EEAC330-78		PA12 HOSE 8X10

PART NUMBER	IMAGE	DESCRIPTION
EEAC330-75		SILICON TUBE 10 MT MM 3X6 OIL
EEAC333-16		ANALYZER TUBE WITH PRESSURE REDUCER HFO
EEAC333-12		BLUE HOSE 3.8 M HFO 1234YF M/M 12X1,5
EEAC333-13		RED HOSE 3.8 M HFO-1234YF M/M 12X1,5
TUBX109-OT		COPPER HOSE T4 EVAP-FILTER YF BRASS FITTING
TUBX110-OT		COPPER HOSE T10 CKV1-COMPR YF BRASS FITTING
TUBX122-OT		COPPER HOSE T1 HP VALVE-EV1 YF (BRASS FITTING)
TUBX123-OT		COPPER HOSE T2LPVALVE-EV1 YF (BRASS FITTING)
TUBX124-AI		STAINLESS STEEL TUBE T5 EVAP-COND
TUBX125-AI		STAINLESS STEEL TUBE T9 COMPR.-SEP..
TUBX126-OT		COPPER HOSE T13 EV19-HYBRID HP BRASS FITTING
TUBX127-OT		COPPER HOSE T13 EV19-HYBRID LP BRASS FITTING
VLV1170		SOLENOID VALVE ODE 12 V.

PART NUMBER	IMAGE	DESCRIPTION
VLV1175		SOLENOID VALVE ODE 12 V.
EEAC330-80		CHECK VALVE B04 ODE
EEAC330-82		CHECK VALVE M1/4"- M1/4" SAE
EEAC330-83		CHECK VALVE M3/8"- M3/8" SAE
EEAC330-85		SAFETY VALVE 1/8" G. 1BAR
EEAC333-18		GAS ANALYZER HFO-1234YF



SIMPLY EFFICIENT

ECO NEXT ONE

IDSC HOLDINGS LLC.

2801 80TH STREET

KENOSHA, WI. 53143-5656

Notice: The information contained in this document is subject to change without notice. Snap-on Equipment makes no warranty with regard to this material. Snap-on Equipment shall not be liable for errors contained herein or for incidental consequential damages in connection with furnishings, performance, or use of this material. This document contains proprietary information which is protected by copyright and patents. All rights are reserved. no part of this document may be photocopied, reproduced, or translated without prior written consent

For Parts And Service Call Snap-on Equipment 1.800.225.5786