



# ***Operators Manual*** - Pro32

***Conventional Sensor Systems***



# Safety Information

For your safety, read this manual thoroughly before operating the equipment.

The Aligner is intended for use by properly trained skilled automotive technicians. The safety messages presented in this section and throughout the manual are reminders to the operator to exercise extreme care when performing wheel alignments with this product.

There are many variations in procedures, techniques, tools, and parts for servicing vehicles, as well as the skill of the individual doing the work. Because of the vast number of vehicle applications and potential uses of the product, the manufacturer cannot possibly anticipate or provide advice or safety messages to cover every situation. It is the automotive technician's responsibility to be knowledgeable of the vehicle to be aligned. It is essential to use proper service methods and perform wheel alignments in an appropriate and acceptable manner that does not endanger your safety, the safety of others in the work area or the equipment or vehicle being serviced.

It is assumed that, prior to using the Aligner, the operator has a thorough understanding of the vehicle systems being serviced. In addition, it is assumed he has a thorough knowledge of the operation and safety features of the alignment rack or lift, and has the proper hand and power tools necessary to perform wheel alignments.

When using your garage equipment, basic safety precautions should always be followed, including:

1. Read all instructions.
2. Care must be taken as burns can occur from touching hot parts.
3. Do not operate equipment with a damaged power cord or if the equipment has been dropped or damaged until it has been examined by a qualified serviceman.
4. Do not let cord hang over edge of table, bench or counter or come in contact with hot manifolds or moving fan blades.
5. If an extension cord is necessary, a cord with a current rating equal to or more than that of the equipment should be used. Cords rated for less than the equipment may overheat. Care should be taken to arrange the cord so that it will not be tripped over or pulled.
6. Always unplug equipment from electrical outlet when not in use. Never use the cord to pull the plug from the outlet. Grasp plug and pull to disconnect.
7. Let equipment cool completely before putting away. Loop cord loosely around equipment when storing.
8. To reduce the risk of fire, do not operate equipment in the vicinity of open containers of flammable liquids, such as gasoline.
9. Adequate ventilation should be provided when working on operating internal combustion engines.
10. Keep hair, loose clothing, fingers, and all parts of body away from moving parts.
11. To reduce the risk of electrical shock, do not use on wet surfaces or expose to rain.
12. Use only as described in this manual. Use only manufacturer's recommended attachments.
13. ALWAYS WEAR SAFETY GLASSES. Everyday eyeglasses only have impact resistant lenses, they are NOT safety glasses.

**IMPORTANT!! SAVE THESE INSTRUCTIONS  
DO NOT DISCARD!!**

## Safety INSTRUCTIONS

### IMPORTANT!! SAVE THESE INSTRUCTIONS



Risk of electrical shock.

- **Do not operate equipment with a damaged power cord or if the equipment has been dropped or damaged, until it has been examined by a qualified service person.**
- **If an extension cord is necessary, a cord with a current rating equal to or greater than that of the equipment should be used. Cords rated for less current than the equipment can overheat.**
- **Unplug equipment from electrical outlet when not in use. Never use the cord to pull the plug from the outlet. Grasp plug and pull to disconnect.**
- **Do not expose the equipment to rain. Do not use on wet surfaces.**
- **Plug unit into correct power supply.**
- **Do not remove or bypass grounding pin.**

*Contact with high voltages can cause death or serious injury.*



Risk of electrical shock. High voltages are present within the console unit.

- **There are no user serviceable items within the console other than the keyboard and printer.**
- **Service on the unit must be performed by qualified personnel.**
- **Do not open any part of the console other than noted areas.**
- **Turn power switch off and unplug the unit before servicing.**

*Contact with high voltages can cause death or serious injury.*



Risk of eye injury. Debris, dirt, and fluids may drop from vehicles.

- **Knock off any loose debris. Clean surfaces as needed to avoid any materials from falling.**
- **Wear approved safety glasses when servicing.**

*Debris, dirt, and fluids can cause serious eye injury.*



Risk of crushing. Vehicles may roll off alignment lift if not secured.

- **Leave automatic transmission in park or manual transmission in gear unless equipment operation steps require vehicle in neutral.**
- **Apply parking brake unless equipment operation steps require wheel movement.**
- **Use wheel chocks whenever vehicle is positioned on the lift.**
- **Follow rack or lift manufacturer's safety recommendations when lifting a vehicle.**

*Vehicles rolling off lifts can cause death or serious injury.*



Risk of entanglement or crushing. There are moving parts on vehicle lifts during operation.

- **Keep all persons clear of lifts.**
- **Read lift manufacturer's operation instructions carefully.**
- **Follow lift manufacturer's safety recommendations.**

*Contact with moving parts could cause injury.*



Risk of pinching or crushing body parts when jacking vehicles.

- **Keep hands and other body parts away from jacking surfaces.**
- **Do not use unapproved adapters (i.e. wooden blocks) when jacking a vehicle.**
- **Do not bypass any jack manufacturer's safety features.**
- **Read jack manufacturer's operation instructions carefully.**
- **Follow jack manufacturer's safety recommendations.**

*Improperly used or maintained jacks can cause injury.*



Risk of burns.

- **Do not touch hot exhaust systems, manifolds, engines, radiators, etc.**
- **Wear gloves whenever performing a service near hot components.**

*Hot components can cause burns.*



Risk of injury. Tools may break or slip if improperly used or maintained.

- **Use the correct tool for the task.**
- **Frequently inspect, clean, and lubricate (if recommended) all tools.**
- **Follow recommended procedures when performing vehicle services.**

*Tools that break or slip can cause injury.*



# Table of Contents

<b>Safety INSTRUCTIONS .....</b>	<b>II</b>
<b>Introduction .....</b>	<b>1-1</b>
Getting started .....	1-1
Assembly and Setup .....	1-1
Aligner Location .....	1-1
Power ON .....	1-1
Aligner Components .....	1-2
Console .....	1-2
Sensor connections .....	1-2
Computer Connections .....	1-2
Wheel Clamps .....	1-3
Measuring Sensors .....	1-3
Aligner Software .....	1-4
Screen Layout and Navigation .....	1-5
Remote Display Unit (Optional) .....	1-6
Toolbar Buttons .....	1-7
<b>Setup - Preferences .....</b>	<b>2-1</b>
Preferences Screen .....	2-1
Preferences Tab Flow Chart .....	2-2
Interaction .....	2-3
Features .....	2-3
Displays .....	2-4
User Login .....	2-4
Logout .....	2-5
Lost or Forgotten Passwords .....	2-6
Usage Log .....	2-6
Security .....	2-6
Units .....	2-6
Resolution .....	2-7
Angle Units .....	2-7
Linear Units .....	2-8
Loading Units .....	2-8
Pressure Units .....	2-8
Connectivity Options .....	2-8
Romess Inclinometer .....	2-8
Select Wizard .....	2-8
Store Name .....	2-9
Regional Settings .....	2-9
Languages .....	2-9
Specifications .....	2-10
System .....	2-10
Turntables .....	2-10
Sensors .....	2-11
Shutting Down the Computer .....	2-11

<b>Steps to Performing a 4-Wheel Alignment</b>	<b>3-1</b>
Mounting the Wheel Clamps	3-2
Optional Wheel Clamp Accessories	3-3
Hub Flange Adapter for “Wheel off” adjustments	3-3
Home Alignment Tab	3-4
Using the Wizard Procedure	3-5
Wizard versus Manual Operation	3-5
Typical Wizard Procedures	3-5
Sample alignment process.	3-5
Run Wizard	3-5
Begin a New Alignment	3-6
Select Vehicle Manufacturer, Year and Model	3-6
Vehicle Manufacturer or Make	3-6
Selecting a Default Make	3-6
Vehicle Year	3-7
Vehicle Model	3-7
Custom Specifications	3-7
View Specifications	3-8
Editing Specifications	3-8
Adjustment Animations	3-8
Additional Assistance	3-9
Enter Customer Data (Advanced Feature)	3-9
Adding Customer Information	3-10
Selecting a Stored Record	3-10
Recalling a Previous Alignment	3-10
Adding a New Customer	3-10
Editing an Existing Record	3-11
Inspection	3-11
Using Inspection Reports	3-12
Perform Runout Compensation	3-12
Runout Status	3-13
More Information on Runout	3-14
Lower Wheels and Bounce (settle) the Suspension	3-15
Perform Caster Turn	3-15
Automatic or Manual Caster Sweep	3-15
Turn Wheels Straight Ahead	3-16
Information about Caster Accuracy	3-16
Vehicle Sensitive Alignment (VSA)	3-17
Calibration Check	3-17
Vehicle Dimensions / Setback	3-17
All Readings	3-18
Rear Readings	3-18
Cross Values / Total Toe	3-18
Readings Toolbar	3-19
Front Readings Screen	3-20
Loop Button	3-21
Zoom	3-21
Print Results	3-21
Inspections	3-22
MAP	3-22
Vehicle Dynamics	3-22
Manual Diagnostics	3-23
Automatic Diagnostics	3-23
Bent Parts Diagnosis	3-23



Table of Contents

---

<b>Measure</b> .....	<b>3-24</b>
Steering Axis Inclination (SAI) and Included Angle (IA) .....	3-25
Measuring Steering Axis Inclination (SAI) and Included Angle .....	3-25
Camber at Zero Toe .....	3-26
Vehicle Dimensions / Setback .....	3-27
Toe-Out-On-Turns (or Turning Radius) .....	3-27
Maximum Turn Angle .....	3-28
Toe Curve Change .....	3-29
Ride Height .....	3-29
<b>Adjust</b> .....	<b>3-30</b>
Live Caster, Camber and Toe .....	3-31
Elevated Camber and Toe .....	3-31
Adjust Caster and/or Camber, Toe on Turntables .....	3-32
Adjust Caster, Camber and Toe Elevated .....	3-33
Adjust Front Camber Elevated .....	3-34
Adjust Rear Camber Elevated .....	3-34
3-35	
Adjust A-arms .....	3-35
EZ Toe .....	3-36
Cradle Adjust .....	3-37
Drag Link Adjust .....	3-38
Single Tie Rod Adjust .....	3-38
Shims and Kits .....	3-39
Default Part Vendor .....	3-39
INFO .....	3-39
Front Offset Cam Bushings .....	3-40
ADR Adjustment .....	3-40

## Table of Contents

---

<b>Maintenance</b>	<b>4-1</b>
Maintenance Menu .....	4-1
Calibration Menu .....	4-2
Camber/SAI/Cross Toe Calibration .....	4-2
Calibration Factors .....	4-2
Calibration History .....	4-2
ISO Certification .....	4-3
Front Sensor Calibration procedures .....	4-4
Rear Sensor Calibration .....	4-7
Preventative Maintenance .....	4-8
Maintenance Checklist .....	4-8
Maintenance History .....	4-8
Wizards - Editing and Creating .....	4-9
Modifying Existing OEM Wizards .....	4-9
Adding a Procedure .....	4-9
Deleting a Procedure .....	4-9
Adding a Wizard .....	4-10
Loop Back to Previous Step .....	4-10
Skip Allowed .....	4-10
Speaker Training (Voice Control) .....	4-11
Database Utilities .....	4-12
Windows® Utilities .....	4-12

## Introduction

The following chapters detail basic, advanced and platinum software features which may or may not be included in all aligner models. This document primarily is designed to cover software navigation and features with minimum regard to the hardware platform in which it resides. There are many variations of aligner models each of which may utilize different features of the base software package.

## Getting started

The aligner software offers extraordinary power and versatility. This section of the manual describes how to begin enjoying the many features and benefits. References are often made to other sections of the Operator's Manual.

## Assembly and Setup

Installation and setup of a new aligner is best handled by a qualified Representative. If unsure of who to contact, refer to the backpage of this manual.

The aligner must be calibrated to at least one rack, lift, or other surface where wheel alignments are to be performed.

All software is loaded onto the computer's hard drive. The Software Discs shipped with the unit contains the alignment software as a backup, and is not needed when performing alignments. All standard alignment features are activated at manufacture. Advanced features are activated as they are purchased with "Activation Codes".

Setups for the PC hardware and Microsoft® Windows® are preset at the factory to maximize performance and should not be altered.

## Aligner Location

Locate the aligner in a location that provides the most convenience for the operator. Visual contact with the monitor is necessary during most steps of a wheel alignment.

## Power ON

The main power switch for the aligner is located on the rear of the cabinet. This switch applies power to all of the aligner's components. Most of the individual electronic components contain a power switch as well. Make sure the monitor's power switch and the computer's power switch (in cabinet drawer) are left in the ON position at all times.

When the power switch is turned on, the unit initiates the computer boot-up. The boot sequence may take several minutes. If any problems are encountered during the boot-up sequence, consult the Maintenance and Service section of this Operator's Manual. The computer will automatically load the alignment software beginning with the logo screen. Click OK to advance to the Home Alignment screen indicating the aligner is ready for operation.

## Aligner Components

### Console

The console houses many of the aligner components including the power supplies, the computer system, the sensor interface components, and provides places for the display monitor, keyboard, and printer. The measurement sensors are stored on the sides of the cabinet when not in use.

The upper shelf of the console provides a location for the display monitor and space for a mouse and keyboard.

The console also houses the computer system and a sliding drawer for a printer.

**NOTE:** Do not expose the aligner or measuring sensors to water, heavy dust environments, or operations that produce metal chips. Do not block the rear of the computer or disable the cooling fan.

### Sensor connections

The sensor interconnect cables plug into the back of the console. There are 6 female connectors – one for each of the 4 sensors, one for the optional remote display unit, and one spare. When the aligner is utilized with a rack wiring kit, all 6 connectors are used. The connectors are universal – it does not matter which sensor is plugged into any of the 6 connectors.

**CAUTION! DO NOT CHANGE COMPUTER CONNECTIONS OR COMPONENTS UNLESS INSTRUCTED BY AUTHORIZED PERSONNEL.**

**CAUTION! CALL FOR A CERTIFIED TECHNICIAN IF YOU ARE IN DOUBT AS TO HOW TO MAKE ANY CONNECTION. MAKING A CONNECTION INCORRECTLY COULD DAMAGE THE UNIT AND VOID THE WARRANTY.**

### Computer Connections

Installation of the aligner includes connection of devices to the computer. Care should be taken if there be any reason to examine those connections, or change a component such as the pointing device.

Note: Refer to the manuals supplied with the computer and the maintenance chapter for computer connections.

CAUTION! THERE ARE NO SERVICEABLE PARTS INSIDE THE COMPUTER. DO NOT ATTEMPT TO OPEN THE COMPUTER CASE FOR ANY REASON. CALL FOR SERVICE IF A COMPUTER PROBLEM IS SUSPECTED.

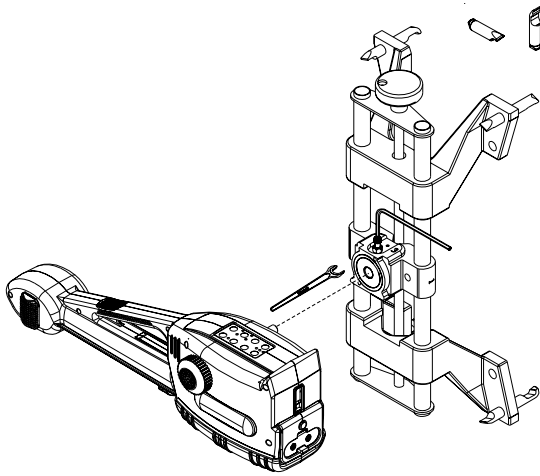

### Wheel Clamps

Wheel clamps are adjustable to different wheel sizes and types. The center slide is adjustable allowing for a clear line of site for the toe measurement system. The slide bracket can be moved to any position prior to wheel runout compensation.

Two types of rim claws are supplied, one standard set and a set used for those vehicles with lug mounted wheel covers.



### Measuring Sensors

Each Measuring Sensor is mounted to a wheel clamp. To attach, make sure the pivot shaft key way is facing up, then insert the shaft into the hole in the clamp center slide. Tighten the Hex Head Cap Screw, then tighten the jam nut to prevent loosening.

There are 2 basic sensors, a right and a left. Each sensor is configured for front or rear use. To configure, press the orientation button for three seconds, then with each subsequent depression the indicator LED will alternate between front or rear. Press "Enter" when desired location is selected.

**NOTE:** Once the sensor is configured *and* calibrated, it must remain in that position.

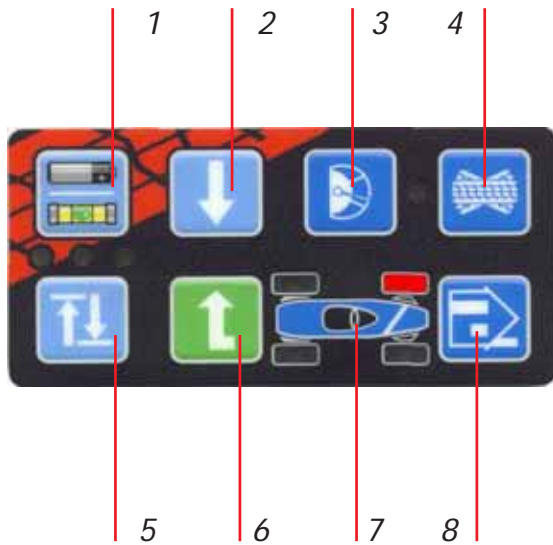

Most functions of the aligner can be controlled from the measuring sensors. Study the keypad to become familiar with the layout of the sensor controls which are:

- 1 Battery condition/Sensor level
- 2 Next
- 3 Meters screen
- 4 Runout
- 5 Tab
- 6 Enter
- 7 Sensor Configuration
- 8 Home

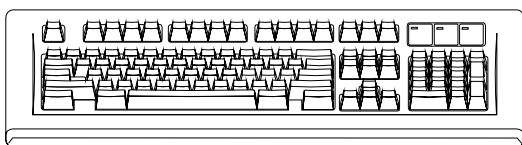
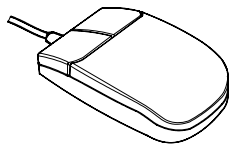
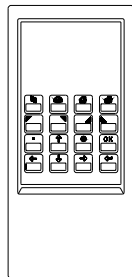

### Aligner Software

There are several ways to control movement within the aligner program. In addition to the sensor keypad discussed earlier, all aligner models are equipped with a hand-held remote control whose various buttons permit full aligner function.

Operation from the console is accomplished primarily by a single mouse click to initiate each function. The right mouse button is not utilized within the alignment software.

A standard keyboard is included for data entry. All aligner functions can also be controlled from the keyboard similar to the remote and the measuring sensors. The function keys (F1 - F12) located on the top row of the keyboard have decals that are the equivalent of the remote and buttons.

In addition, the keyboard has a "Print Screen" key. When this key is pressed the currently displayed screen will be captured and printed.



## Screen Layout and Navigation

The software features a common interface throughout its many screens. Becoming familiar with the various screen navigation functions is essential for efficient use of the aligner.

**1-Toolbar** – these buttons appear on every screen, and correspond to the F1-F12 keys on the keyboard, as well as the keys on the remote. The functions for F1-F4 are common to every screen, while the functions of F5-F12 vary depending on the screen

**2-Screen Tabs** – these tabs move to other major areas of aligner operation. Each tab contains a new set of Function Icons to perform functions related to the title on the tab

**3-Function Icons** – when the pointer is positioned over any function icon, a text pop-up appears describing its function. When the left mouse button is clicked, this function begins

**4-Status Bar** – contains aligner setup and information on the vehicle selected

**5-Text Fields** – some screens have text blocks that allow the user to type information

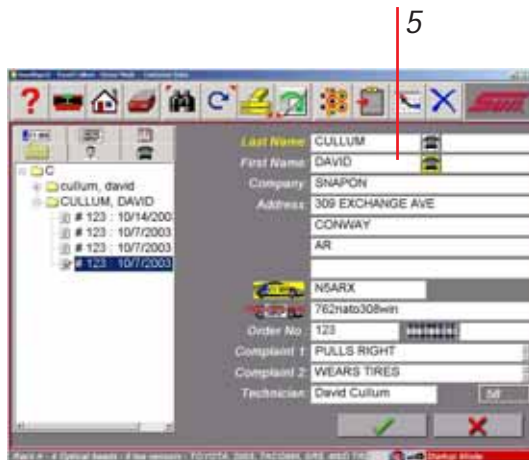

**6-Radio Buttons** – enables the selection of one item among a list. Click on the button to the left of the description to enable that function

**7-OK and Cancel Buttons** – most screens have these two buttons. **OK** saves the information and/or tells the software the user is ready to move to the next step. **Cancel** leaves the screen, losing the information and/or moving back a step, or possibly skipping the step shown on-screen

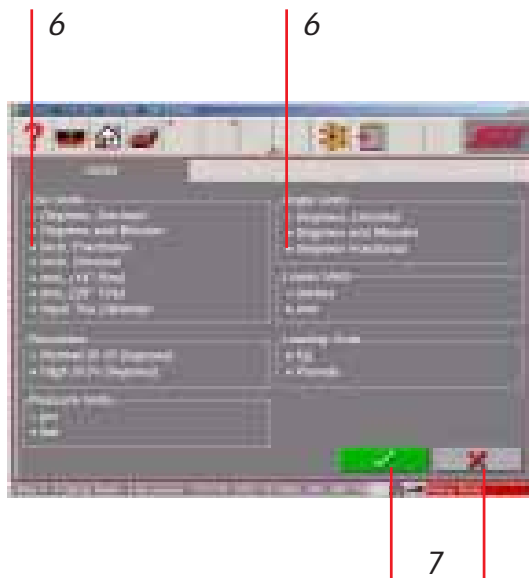



8



**8-Drop-Down Selection Boxes** – used on several screens to choose among different options

9

10

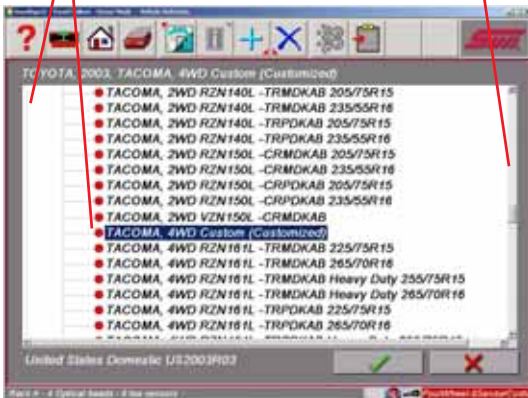

**9-Drill Down Selections** – on the Vehicle Selection screen there are a series of choices with an arrow next to them. To make a manufacturer selection, double-click with the pointing device to expand to the next level. Double-click on the year to further expand for the model selections. To completely contract the selection, double-click on the arrow or name of the manufacturer

**10-Scroll Bars** – when these are present on the screen, either vertical or horizontal, clicking on the arrow moves the screen view in that direction to show additional selections or information. You can also click and hold the center slider and move it up or down to create large movement.

**Click to Select** – some screens feature columns and rows where a specific action is indicated. To use these, click in the box as desired

**Remote Display Unit (Optional)**

The optional Remote Display unit is handy when adjusting the vehicle. It is not necessary to be in visual contact with the console, since the Remote Display can show all necessary information. There are 2 LED windows to show live angle readings, an LCD display that shows information about the current function, and a full operational keypad.

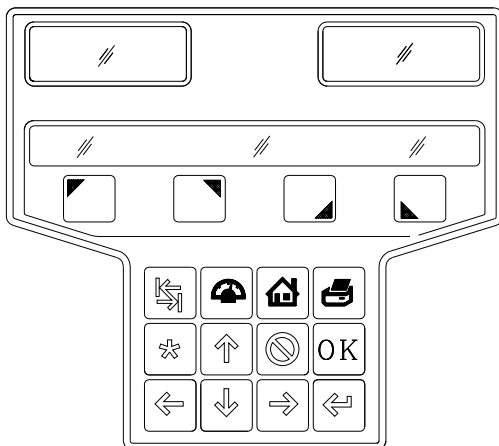



## Toolbar Buttons

Toolbars are found on every screen within the software. The following legend identifies the button and refers to the pages where the button's function is described.



**Help** – launches context-sensitive help screens.



**Meters** – jumps directly to the alignment meter screens.



**Home** – jumps directly to the Home Alignment tab.



**Print** – launches the Print Report screen.



**Measure** – from any readings screen, launches the Measure screen.



**Adjust** – from any readings screen, launches the Adjust features.



**Animation** – launches help with performing angle adjustments.



**Zoom** – makes the selected meter fill the entire screen.



**Unzoom** – returns from a zoomed meter to the standard meter screen.



**Custom Specifications** – when selecting a vehicle, brings up any custom vehicles that have been saved.



**Restore OEM** – during editing of specs, returns to OEM values.



**Plus and Minus** – when editing specs, values increase or decrease.



**Delete** – during custom specs, deletes the highlighted record.



**Check** – during inspections, creates entry “checked”.



**Service** – during inspections, indicated the item has been serviced.



**Replace** – during inspections, indicated the item has been serviced.



**Languages** – allows the on-screen or printout languages to be changed.



**Wizard** – allows selection of a different Wizard process.



**Login** – allows login and logout of users.



**Edit Setup** – allows changing of system setup items



**Shop Management** – if equipped, connects to the shop management system.



**Mercedes Benz “MKS” Measurement System.**



**Information System** – if equipped, calls up vehicle repair information.



**About** - Gives information regarding software revision and options along with copyright statement.



**Logo Screen** - Selecting this button displays the Logo screen for display during idle time.



**Manual Caster Swing** - Selecting this button during the caster swing process allows the wheel to be moved to the degree desired by the operator while observing the turnplate scales.



**Automatic Caster Swing** - Choose this button to revert back to automatic caster mode.



**Aligner Diagnostics** - Sensor values can be observed and analyzed during readings display in the event of concern.



**Find** - During the customer data entry process, selecting this button allows the user to search for an archived file using “Name”, “Phone” or vehicle “License” number.



**Download** - Occasionally, firmware updates are made available for enhanced sensor operation or addition of features. Select this button to begin the load process. NOTE: Sensors should be corded during download, not cordless.



**Current Record** - Recall the Customer record that is currently stored in memory.



**Clear All Fields** - Select this button to clear all fields within the data file currently open.



**Sensor Voltage** - This displays a screen showing values critical for proper cordless operation.



**Recall the Current Alignment** - Displays the current alignment stored values.



**Toggle Editing Mode** - Select this button to toggle the method of editing a displayed specification. A custom specification can be edited by either using the +/- keys or by directly entering desired values.



**Setup for Multiple Aligners** - While in the data base maintenance screen select this button to setup multiple aligners so they may share a common customer alignment data base.



**Calibration Utilities** - Stored calibration factors can be saved and retrieved. Files containing factors and other data can be saved to a floppy for retrieval or restoring to a machine.



**Setup** - The Preferences Menu is selected from the toolbar icon when a *basic* software package is used as the operating system.



**A-Arm Toggle** - Click to change from adjusting the upper A-Arm to the Lower A-Arm.



**Set Default Make** - Choosing this Icon while a specific make vehicle is highlighted will make that make the default so it is selected whenever specs are viewed.



**Quick Align** - Choosing this Icon allows several steps in the selected wizard to be skipped taking the operator to Readings in the shortest means possible.



**ISO Certification** - Select to display ISO certification diagnostic report used to troubleshoot measurements



**Rolling Runout** - Select to perform a "Rolling Runout" procedure. Rolling runout allows compensation to be performed by rolling the vehicle. Rolling runout may be used in lieu of standard runout to avoid jacking the car. It may be used if ample space exists on the rack to roll the vehicle back 180 degree rotation of the wheels.

## Setup - Preferences

The Preferences Tab is used to setup various functions and features within the software. Numerous operating attributes or “preferences” can be altered to suit the operator’s individual tastes. Although the aligner is shipped with the most common elements selected as default, an operator is able to tailor several elements of the alignment process as well as the display features to customize his machine. Operator preferences can be altered before the alignment process begins or any time thereafter.

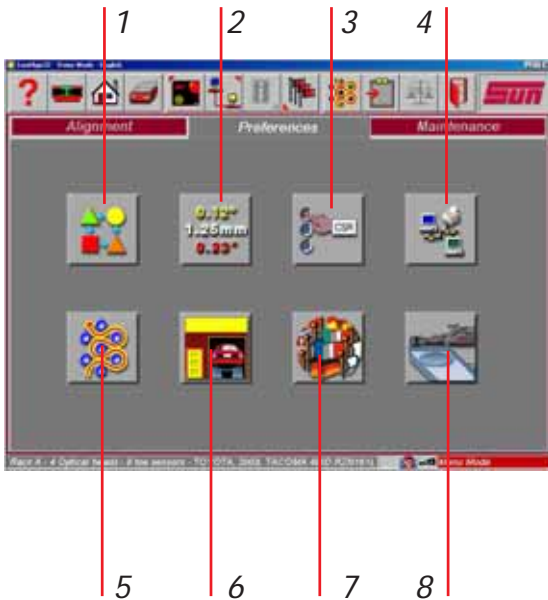

### Preferences Screen

The Preference Screen allows access to the following setup selections, each identified by an icon.

- 1- Interaction** – controls several functions, which alters interaction between the software and the user
- 2- Units** – selects the units to be displayed for angle and linear measurements
- 3- CSR** (password protected) – allows a Service Technician to access controlled maintenance screens
- 4- Connectivity** – activates access to a shop management networking system
- 5- Wizard** – allows selection of any pre-programmed alignment sequences
- 6- Store Name** – allows a store name and address to be entered for the customer printout
- 7- Languages** – selects from various languages for the screen and printout, also selects alignment database
- 8- System** – selects the rack, turntable, and sensor configuration

## Preferences Tab Flow Chart

Many Preference items are selected at the time of aligner installation and do not need to be changed. Others are software, user-interface related and may be changed depending on operator preference. Here is a list of setup items typically found in each category:

### One Time, Upon Installation

Specification Selection Method  
 Sensor Configuration  
 Logo Display  
 Dealer Address and Phone Number for Printout  
 Calibration Check  
 Purchased Software Options  
 Turntables - Standard or Electronic

### User Configuration Changes

Wizard Configuration  
 Rack Selection  
 Units of Measure  
 Languages Used  
 Printed Reports Selection

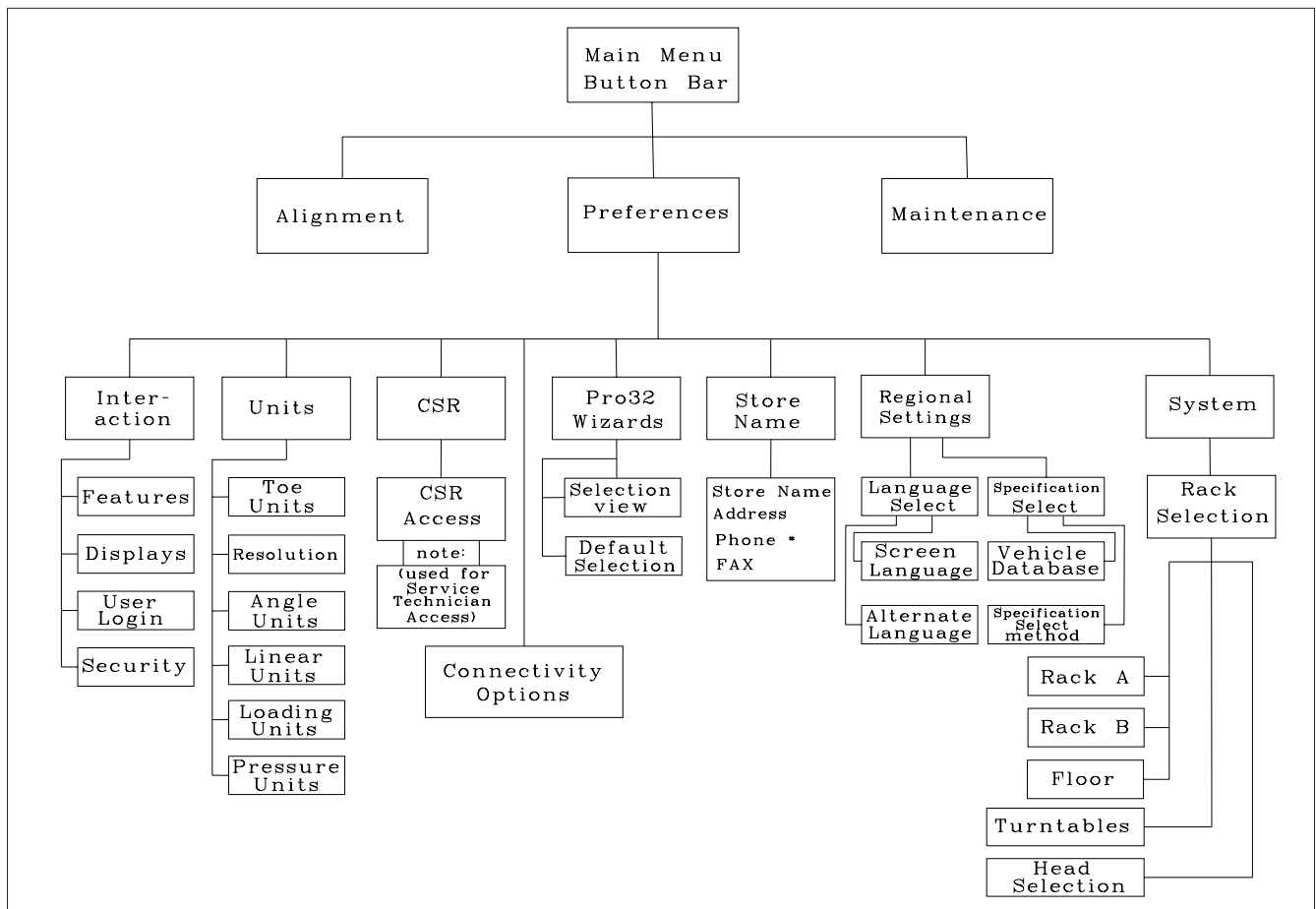

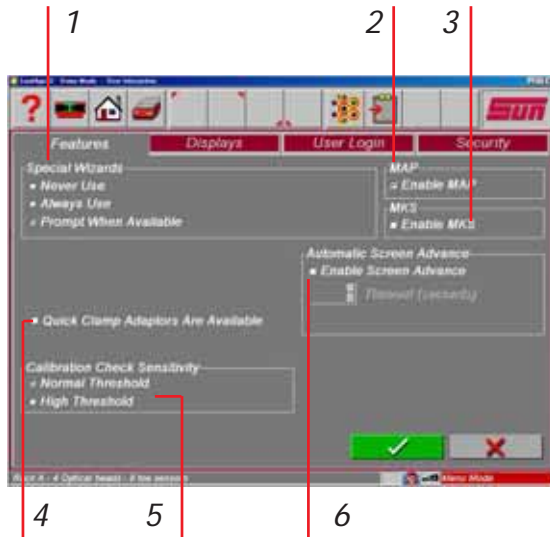

## Interaction

The Interaction icon launches a series of screens that allows alteration of the interaction between the user and the software. The Interaction setup uses tabs as follows:

### Features

This tab provides control of operational properties:

**1- Special Wizards** – Selects how Wizards, including VSA (Vehicle Sensitive Alignment) wizards are applied to the alignment process. Some “OEM” wizards are selected automatically when a specific vehicle is selected. VSA wizard procedures are automatically generated by the aligner dynamically based on the vehicle selected and the angles measured.

**2- MAP** – allows viewing of MAP service procedure guidelines from the Inspection icon.

**3- MKS** - *Mercedes Benz “MKS” Measurement System. OEM process used to validate rack calibration.*

**4- Hub Pin Clamps Available** - Wheel clamps are available for certain applications that use the brake rotor for surface index. This allows a very accurate mounting and one which does not necessarily require runout compensation.

**5- Calibration Check Sensitivity** – alters the point at which an aligner is prompted to re-calibrate. Normal Threshold is recommended. High threshold should only be used in a very high confidence situation, where the operator feels sure that none of the sensors have been compromised since last calibration.

**6- Automatic Screen Advance** - Check this selection to automatically advance past several routine procedures, such as “Steering Wheel Level”. Pause time can also be altered.

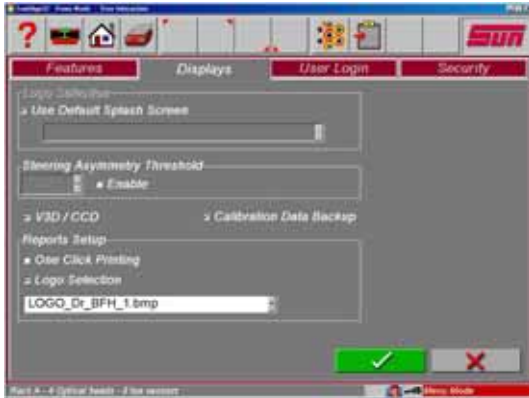

### Displays

**Select Splash Screen** - Select to use the default logo on the Splash Screen or a custom logo may be placed in the “logo” subdirectory of the program on the hard drive for operators who have a license to use them. Users may also create their own logos in the “BMP” (bitmap) graphics format and copy to the “logo” subdirectory.

**Note:** *Unauthorized use of copyrighted logos may be illegal without license or the owner’s permission.*

**Steering Asymmetry Threshold** - This is generally left unchecked in the default value of 0.5 degrees. If the value is changed steering errors may not be detected or may be flagged in error.

**V3D/CCD Selection** - Select the desired measuring system. Some machines may have multiple sensor types. Selecting this feature allows sensors to be toggled from the Main Menu status bar. Generally is left unchecked.

**Calibration Data Backup** - activate capability to backup and restore the calibration data to and from a floppy.

**Reports Setup** - Select “One Click Printing” to send the selected default report to print from any Screen. Select the desired logo to appear on the alignment printout from this setup menu.

### User Login

This utility is used to control access to the aligner software and track usage. When login is activated, only “authorized” users who have been set up with a user name and password can operate the aligner.

The User Login tab allows editing of the operator authorization feature. The Login Setup screen allows operators to be added, deleted or modified. When the *Administrator* is logged in, he can perform several changes within the Login command screen, such as modify, delete, or add users. He can also change whether a user must have a password or not to run





the software. Any number of operators can be added. Users can select a unique password for security. Ultimate control of the operator login process is with the Administrator of the system. The Administrator can be the primary operator, the shop manager, shop owner, or anyone who takes responsibility for the aligner. If the login function is to be activated, it is suggested that the appointed Administrator immediately change his password in order to secure control of the login process.

The aligner is shipped so that no login or password is required to operate the unit. When login is activated, all control will cease until a proper login is registered. To activate the login requirement, the box at the lower left of Login screen must be checked.

To login, select the Login icon (F10) from the toolbar at the top of most screens. Select the operator name among the listed users to begin aligner operation, and enter the password if applicable. Although no password is required, it is recommended when the machine has more than one operator.

When the voice control option is activated, the user database is used to distinguish operators. Each operator is required to “train” the voice control engine to recognize his voice.

**Note:** *If Login is activated, ALL control of the computer is inactivated until a valid operator has successfully logged in with the correct password. The operator can then navigate the alignment software.*

### Logout

Selecting the Login button on the toolbar (F10) when a user is logged in opens the “Logout” window. Two selections are available, Logout and Logout and Shutdown Windows. This screen is used to secure the aligner when not use. Both login and logout commands can be selected anywhere within the program since the icon is present on the toolbar on most screens. Remember, the machine cannot be controlled or even shut down without a proper Login (if activated).

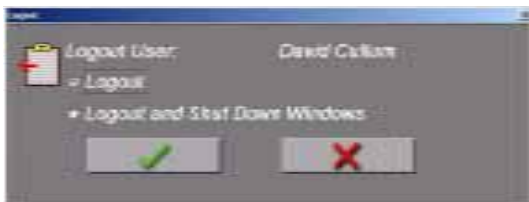



### Lost or Forgotten Passwords

If the “Administrator” loses or forgets his/her password on a machine with Login activated, the operator is required to contact your Technical Support Representative to obtain an authorization code necessary to unlock the software to reenter an Administrator password. If a user forgets his/her password it will be necessary for the Administrator to change the user to a new password.

### Usage Log

Whenever the Login function is activated, all user activity is recorded in a database file on the hard drive called ALIGNMENTDATA.MDB. This data file can be viewed with common database viewers such as Microsoft Access. The file contains most of the data generated by the alignment process.

### Security

Security is a utility screen used to activate advanced or optional features. Some software options may be purchased after the initial sale of the Aligner. To activate optional features, an operator or factory representative will be required to obtain “activation codes” which enables software features. Activation codes are unique to one aligner and may not be used on other machines.

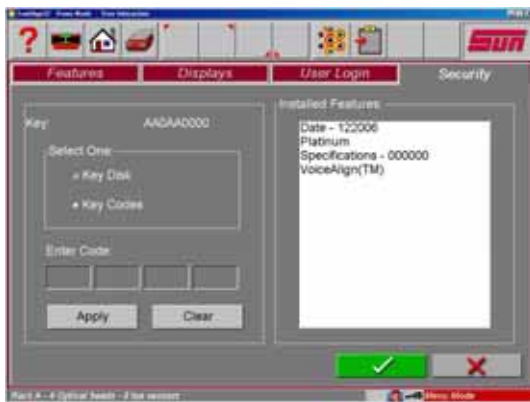

### Units

There are many different units of measurement for wheel alignment angles and dimensions depending on local practices, vehicle manufacturer requirements, or operator preference. Choose the Units icon from the Preferences tab. Click on the radio button next to the desired selection of units of measure. Once a prescribed unit of measure has been chosen, all readings and specifications will be stated in those units on all readings screens.



**Toe Units** – move the pointer over the toe units best suited to the operator's requirements and highlight the button left of the desired unit. The choices are, with examples:

- Degrees, Decimal – 0.5 degrees
- Degrees and Minutes – 0' 30"
- Inch Fractional – 1/4"
- Inch Decimal – 0.25"
- mm (14" rim) – European metric display – 20 mm
- mm, (28" tire) – US metric display – 20 mm
- Input tire diameter – prior to bringing up toe specifications during the alignment program, the Aligner will ask for the actual vehicle tire diameter. The toe specs and readings will then be calculated based on that input value.

#### **Resolution**

Use the Resolution selection to choose how numeric displays are to be read during the alignment program. Choices are Normal (0.10 degree or tenths of a degree) or High (0.01 degree or hundredths of a degree) resolution. Regardless of choice it won't effect the accuracy of the aligner, simply the number of digits after the decimal point and the associated roundoff.

The selection will effect the way Alignment readings are viewed. Adjustments using a 0.10 degree resolution will be easier to obtain than when using the 0.01 degree setting. Aligning the car to within hundredths of a degree requires a greater degree of precision on the technician's part to obtain exact readings.

#### **Angle Units**

Specify the units in which all angular measurements will be displayed such as: caster, camber, SAI, included angle, thrust angle, etc.

Examples:

- Degrees, Decimal – 0.5 degrees
- Degrees and Minutes – 0' 30"
- Inch Fractional – 1/4"

**Linear Units**

Specify the units in which all linear measurements (setback, vehicle dimensions, etc.) will be displayed.

**Loading Units**

Where applicable, values can be expressed in either kg (kilograms) or in lbs. (pounds).

**Pressure Units**

Units depicting pressure as in reference to tire pressure can be expressed in psi or in bars.

**Connectivity Options**

An interface is available for networking the aligner to a shop management computer system. This interface allows sharing of information between the aligner and a host computer. (Optional software required)

**Romess Inclinometer**

This menu is also where the “Romess Inclinometer” is activated for use with certain makes of vehicles, Mercedes Benz for example.

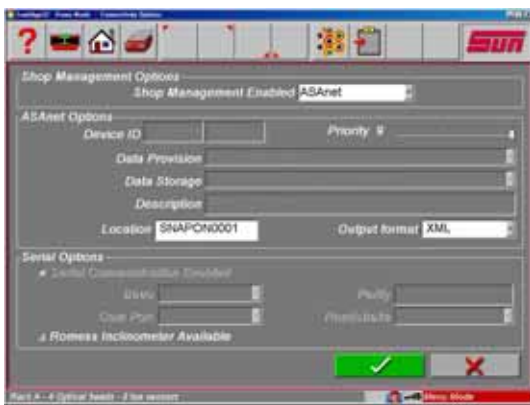

**Select Wizard**

The Wizard selection allows for choosing a pre-programmed alignment process or “Wizard”. The screen also allows selection of a default procedure. The default wizard is initiated whenever the “Wizard” icon is chosen from the Home Alignment screen.

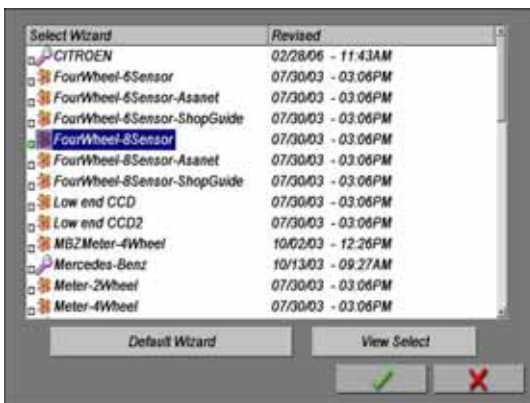

The procedures set the aligner to follow a certain path toward an end result, a completed alignment. Each pre-programmed procedure sets the aligner up to perform certain functions in a predetermined order and whether certain functions can be skipped.

Several OEM procedures are pre-programmed to follow manufacturers recommended alignment methods and are activated when this message is displayed. The Vehicle Sensitive Alignment (VSA) may

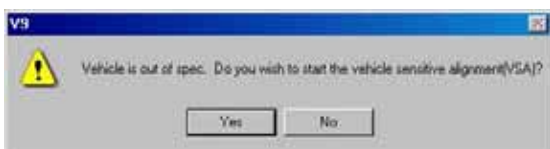

skip certain screens or procedures and only perform those required to complete the alignment for that particular Make and Model. This means faster completion with equal results.

To chose a wizard other than the default for a particular alignment, click on the desired wizard and press OK (or, double-click on the desired wizard). The alignment will then begin using that wizard. To set a different wizard as the default, chose the desired wizard and click on the “Default Wizard” button.

See **“Wizards - Editing and Creating”** in the Maintenance section of this manual for information regarding customizing procedures to suit the unique requirements of a shop.

**Store Name**

Information entered into the Store Name selection will be utilized on the alignment results printout. Several lines of information is available for printing. The name of the business, address, city and state are entered. Also available for display is a phone and fax number if desired.



**Regional Settings**

A variety of different languages are available. This feature allows a printout in a language different from the screen operating language. When the Languages icon is selected from the Preferences tab, two additional tab selection screens appear:

**Languages** – selection of screen language

**Specifications** – select from the database of vehicles from a variety of countries or regions.

**Languages**

To change the screen language, select from the list using the pointing device, or arrow up/down. To select the Alternate Language, use the pointing device to move to down, click to select. Select “OK” when both screen and alternate languages are highlighted. All screens will now be in the chosen language. English is the first selection on both lists should it become necessary to change the unit back to the default setting. Selecting “Ctrl-Alt-F8” toggles to the Alternate language.





### Specifications

The specification tab allows for changing the spec database to suit the country where the aligner is operated. Also selected is the order in which the make, model, and year appear can be altered.

Note: Some automotive markets not specifically identified on this screen have vehicles from a variety of sources. It may be necessary to change databases in order to locate specifications on some vehicles.



### System

The three “Select” buttons on the left side of the System screen allows the aligner to be used on any one of three racks (alignment surfaces) in the shop, which are named by default as Rack A, Rack B, and Floor. The names of each can be changed as desired by editing the text field (i.e. “4-Post Lift”). Any of the three calibrated alignment work surfaces can be utilized as needed by moving the aligner instrumentation. In most shops the primary alignment lift is designated as “Rack A”.

Note: In order to perform accurate alignments, each lift/rack surface must be properly calibrated.

Select the rack type used to perform most wheel alignments. The rack choice must be changed whenever using a different surface for performing alignments.

### Turntables

Each of the above rack/floor selections also contain control for selecting whether each alignment position utilizes Standard mechanical-type or Electronic Turntables. The overwhelming majority of rack/lifts use mechanical-type turntables. Electronic Turntables are offered to automate some measurements such as Toe-Out-On-Turns.

Note: DO NOT select Electronic turntables unless lift is so equipped. Operational problems will be created if an error is made with turntable setup.

### Sensors

Also selected on this screen is the measuring sensor configuration. A two-sensor setting is possible to allow the aligner to be used with the front sensors only on large vehicles where a line of site from the front to rear is not possible.

Once the desired rack, turntable, and sensor configuration has been selected place the pointer over the "OK" button to save the selections.



### Shutting Down the Computer

**CAUTION! TO AVOID DAMAGING IMPORTANT FILES IT IS NECESSARY TO SHUT DOWN WINDOWS PROPERLY BEFORE TURNING OFF OR RESTARTING THE ALIGNER OR THE COMPUTER.**

Use the following steps to shut down the aligner from within the Alignment software:

1. Return to the Home Alignment screen.
2. Click on the "Shutdown Windows" button located in the lower left corner of the Advanced Main Menu screen and in the tool bar of the Basic Menu screen.
3. Answer "Yes" when prompted, the computer system will then shutdown automatically.

From the Windows desktop:

1. Close any programs or windows that may have been opened.
2. Click the Start button, and then click Shut Down.
3. On the Shut Down Windows box that appears, select "Shut down the computer?" Click "Yes" to proceed.
4. The computer will automatically shutdown, if not, a screen message lets you know when you can safely turn the power off to the aligner.





## Steps to Performing a 4-Wheel Alignment

There are many reasons why a wheel alignment may be required on a vehicle, such as:

- Accelerated or uneven tire wear
- Pull, wandering, or other steering / handling problems
- After replacement of worn suspension or steering system components
- After-collision repairs
- Routine vehicle maintenance

Regardless of the reasons for alignment, it is important that the technician performs these steps necessary to address and correct all problems.

1. Gather information from the vehicle owner – ask about any drivability symptoms of misalignment. Inquire if the vehicle has been in a collision or has had any parts replaced recently.
2. Perform a test drive to verify owner’s complaint – try to recreate the problem. If unable to duplicate, have the vehicle owner explain further or have him/her drive with you.
3. Place vehicle on the alignment lift – center the vehicle on the lift and turntables. Raise the lift to a solid, level lock position.
4. Inspect the tires for any signs of abnormal wear – tires often reflect any misalignment conditions.
5. Perform a thorough component inspection. Replace defective parts prior to performing the alignment. Always check tire pressure and ride height.
6. Mount measuring sensors to the vehicles wheels. Use the safety straps in the event of grip failure.
7. Choose the proper Wizard procedure for the vehicle – the best alignment for the majority of vehicles is a four wheel 8 sensor setup, a quality alignment is possible with six sensor systems as well.
8. Perform runout compensation – the purpose of performing runout is to eliminate measurement errors due to the wheel runout and clamp mounting error.
9. Measure caster, camber, and toe.
10. Determine what needs to be done – Examine the vehicle and any reference materials to determine the procedures for angle corrections. Determine what items are needed to correct any problems (i.e. aftermarket kits, special tools, etc.).
11. Make any needed angle corrections – center the steering wheel carefully when prompted. Use this order of adjustment unless directed otherwise by an OEM or VSA procedure:
  - a. Rear camber
  - b. Rear toe
  - c. Front caster
  - d. Front camber
  - e. Front toe
12. Re-center the steering wheel and readjust front toe if needed – crooked steering wheels are the leading cause of customer dissatisfaction with wheel alignments.
13. Print the results – the printout is useful for showing the customer before and after results. Many shops keep a printout on file for future reference.
14. Perform a test drive to verify proper alignment.



## Mounting the Wheel Clamps

Prior to beginning an alignment, attach each wheel clamp/sensor assembly to a vehicle wheel. There are several ways the wheel clamps can be attached to accommodate various wheel configurations.

---

**WARNING! ALWAYS SECURE THE WHEEL CLAMPS USING THE SUPPLIED SAFETY STRAPS ONTO EACH WHEEL TO INSURE THE SENSOR DOES NOT FALL OFF THE VEHICLE.**

---

---

**WARNING! THE CLAMPS AND THEIR HOLDERS HAVE SHARP EDGES.**

---

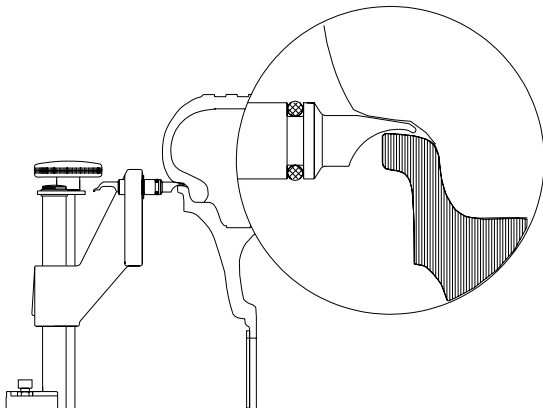

### Method 1

This option is used on many standard and custom rims with no inside bead surface. Use the claw adapters supplied to insert between the tire and the outside edge of the rim. Secure the clamp by turning the lock knob several turns counter-clockwise.

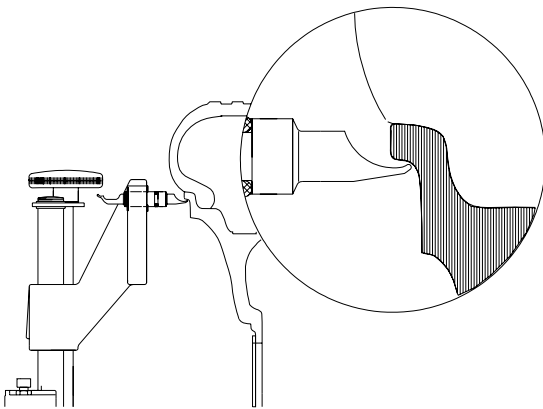

### Method 2

This is used on some standard and custom rims with no opportunity to clamp from the outside of the rim and very narrow edges on the wheel rim. Clamp from the inside of the rim. Secure the clamp from the inside out by turning the lock knob several turns clockwise.

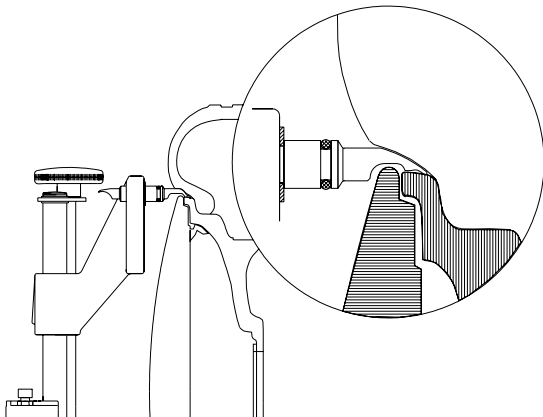

### Method 3

A second set of claws are used on wheels with lug retained wheel covers. These special claws have a rim gripping surface as well as a relief to clear the edge of a wheel cover. Unused claws are stored in the storage area located on the lower clamp slide.

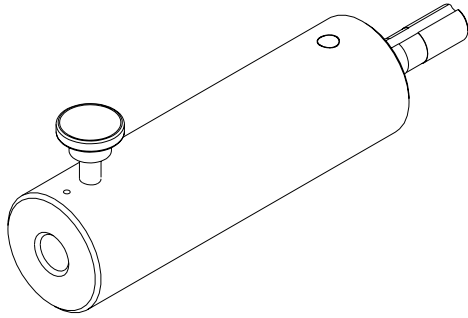

### Optional Wheel Clamp Accessories

An optional shaft extension kit is available to assist with alignment applications where the optical path may be blocked between the front measurement sensor and the rear Measurement sensor. Common applications include some Postal vehicles, motor homes, and some pickup and delivery vehicles. Other applications may include vehicles with fender extensions, running boards with fender flaps, and some dual rear wheel vehicles.

Place the Adapter shaft into the clamp slide and tighten the locking knob and jam nut. Place the sensor shaft on the adapter, tighten the knob, and mount the clamp to the wheel using one of the methods described earlier.

### Hub Flange Adapter for “Wheel off” adjustments

Some vehicles may require alignment adjustment or service to a suspension component requiring the wheel to be removed for access or adjustment.

Some vehicles allow the target clamp assembly to be mounted directly to the brake rotor, while the hub assembly on other vehicles may require the use of this adapter for mounting the target assembly.

This adapter allows the aligner target to be installed for “live” adjustment while elevated.

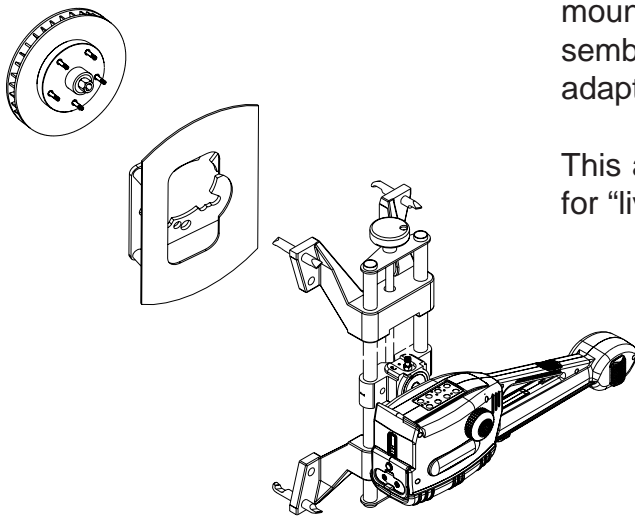

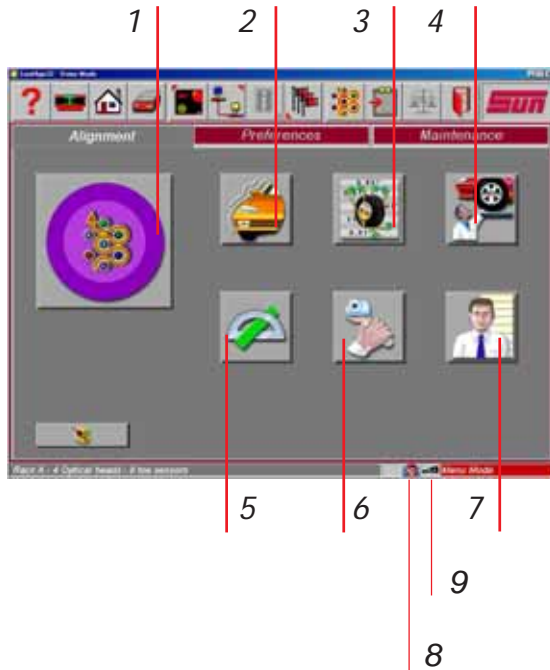

## Home Alignment Tab

All wheel alignment functions begin from the Home Alignment tab which is the default or “home” screen. The screen, contains a series of icons that execute alignment related functions. The Home key, located along the toolbar and on each sensor keypad, always returns to this screen.

**1-Wizard** – The Wizard selection launches a pre-programmed alignment process of gathering the alignment angles. The process is directed by the Wizard that is selected at that time.

**2-Vehicle Selection** – Selects the Make, Year, and Model of the vehicle to be aligned

**3-Vehicle Specification** – Displays the selected vehicle’s alignment specifications and gives access to adjustment animations and assistance

**4-Inspections** – Six Inspection screens are available under Inspections as well as a Diagnostics icon. These are Pre-Alignment Inspection, Tire Inspection, Brake Inspection, Under Car Inspection, Under Hood Inspection, and Courtesy Inspection

**5-Measure** – This group of icons allow quick access to several angular measurement screens such as Caster, SAI, Steering Angles, and Vehicle Dimensions

**6-Adjust** – This selection of icons gives access to a variety of features that assist the technician with adjustment of alignment angles. Some of these features include Live Caster, A-arm Adjust, Rear Shim Programs, and Cradle Adjust

**7-Customer Data** (option) – This advanced feature, when activated, opens a data entry screen used to record customer information and his vehicle information. Information can then be retrieved alphabetically.

**8-Speech Recognition status** (option) - Click to activate.

**9-Sensor type indicator** - Click to toggle between conventional and imaging sensor types.

## Using the Wizard Procedure

The Wizard procedures set the aligner to follow a certain process path resulting in a completed alignment. Each pre-programmed procedure, called a Wizard, sets the aligner up to perform certain functions in a predetermined order and determines whether certain functions can be skipped. Also defined in the Wizard procedure is the measurement sensor setup.

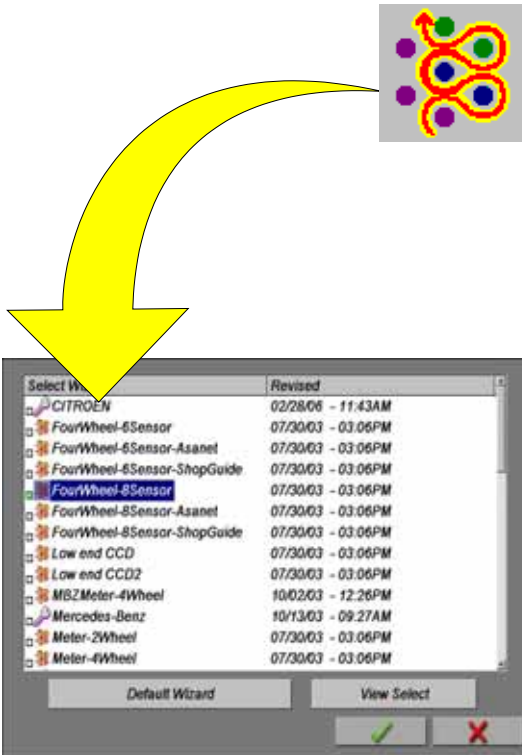

## Wizard versus Manual Operation

When the Wizard icon is selected from the Home Alignment tab, the alignment process is performed using the Wizard that is currently selected. A technician can also choose to manually execute individual alignment functions directly from the Main Alignment tab by pressing the appropriate icon, such as Measure. Generally, it is recommended to use the Wizard process to obtain the initial readings.

## Typical Wizard Procedures

Several Wizard procedures are pre-programmed at the factory to follow manufacturer's recommended and industry recognized alignment methods.

The aligner will process a default Wizard unless otherwise specified. To change wizards, click on the wizard icon on the toolbar or use the setup found on the Preferences tab.

## Sample alignment process.

The following procedures are based on an alignment process from start to finish using the standard 4 wheel 8 sensor wizard.

### Run Wizard

Click on the Run Wizard icon on the Home Alignment screen.



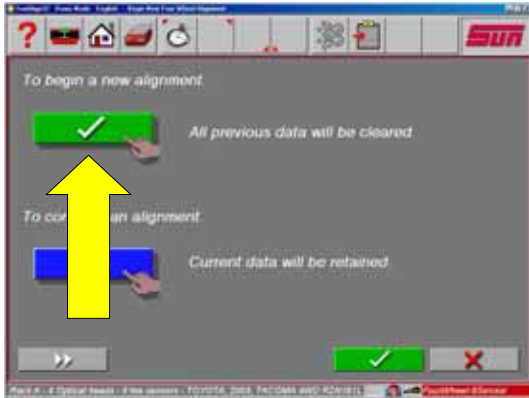

### Begin a New Alignment

This screen gives the choice to start a new alignment or continue with an alignment already in progress. If the “OK” icon is selected the computer memory of the previous alignment is erased allowing a new customer and vehicle to be setup. If the “Continue current alignment” icon is selected, all customer, vehicle, and alignment measurements are retained and the software returns to the alignment readings screens.

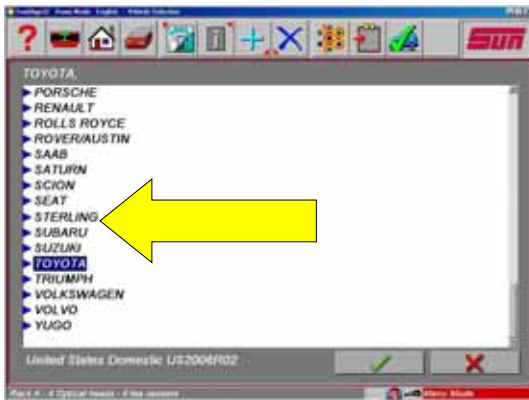

### Select Vehicle Manufacturer, Year and Model

Note: The order the manufacturer, year, and model appear will vary depending on how the specifications are set up.

### Vehicle Manufacturer or Make

This screen shows the vehicle manufacturers in the specification database. The vertical scroll bar on the right indicates there are additional choices further down the page. Click on the down arrow on the scroll bar move down. Using the down arrow key on the keyboard also moves down the screen. Once the desired manufacturer is in view, double-click on the name to expand out the model selections. Double-click again to contract. Also, the keyboard’s right arrow key expands and the left arrow key contracts the list.



### Selecting a Default Make

To select a desired Make of Vehicle as “Default so it comes up first every time, highlight the Make then click on “F10” select default make Icon. This will anchor the selection. This is useful for dealership or shops that work on same makes the majority of the time.

Note: To move to the manufacturer selection quicker, using the keyboard, press the first letter of the manufacturer name. This causes the selection bar to move directly to the first name starting with that letter (i.e. press “H” - moves to Honda).

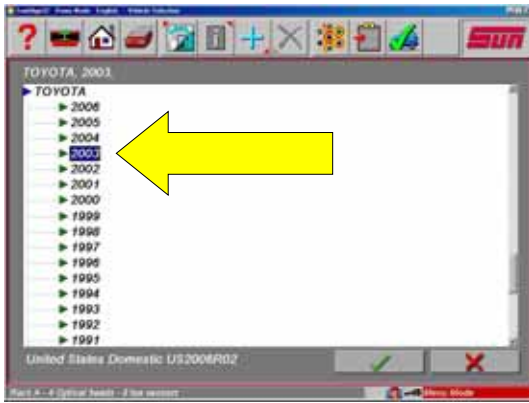

### Vehicle Year

Select the year of manufacture using the up/down keys or pointing device on the scroll bar to move up or down to the desired year, then double-click or press the right arrow key to expand out the years this model was made.

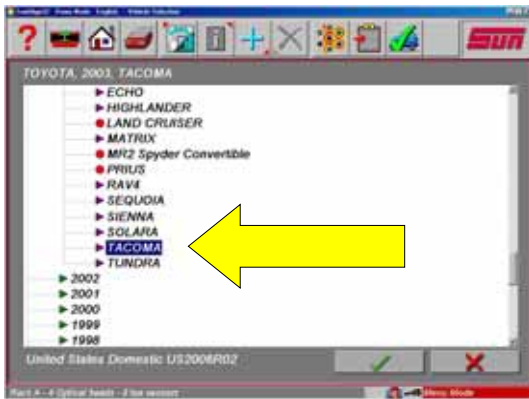

### Vehicle Model

Use the direction keys or pointing device to select the model of the vehicle, then select "OK", press Enter, or double click the selection.



### Custom Specifications

Alignment specifications that have been added by the operator reside in a special database. To retrieve these specifications go to the Vehicle Manufacturers screen and select Custom Specifications on the toolbar (F5). Any custom specifications that have been previously added will be listed in a similar manner as the OEM specs. Click on F5 again to return to the OEM specification selection page.

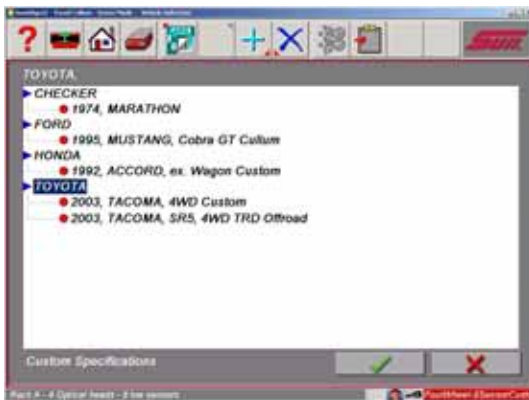

Additional custom specifications can be added by clicking on the "plus" button (F7) on the toolbar (see below for details). Records are deleted by first highlighting the record and then clicking on the "X" button (F8) on the toolbar.





### View Specifications

This screen displays the Year, Manufacturer, and Model of the selected vehicle with Minimum, Preferred and Maximum specifications for the front and rear wheels. Dashes in any position indicate there are no manufacturer specifications for that wheel or angle. A “wrench” icon to the right of the specifications field indicates that assistance is available for adjusting that angle. Clicking on the wrench launches the adjustment help features described on the next page. The Edit Specs toolbar button (F8) allows editing of the displayed specifications prior to beginning the measurements.

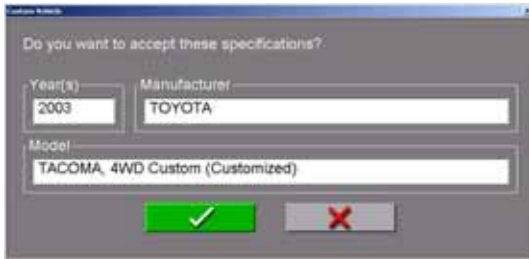

### Editing Specifications

To edit the displayed specifications, click on toolbar button F8, Edit Specifications. The toolbar configuration will change, with a plus and minus sign displayed (F6 and F7). Use the pointer to click on the specification to be edited (i.e. left camber). Once it is highlighted, use the plus and minus buttons to change the specification as needed. Notice that when the left value is changed the right value changes at the same time. Use the pointer to move to any other values to be changed. If any mistakes are made, or the user wants to return to manufacturer’s specifications, click on Restore (F8). When all editing is complete, click on OK. Since these edited specs are now custom, a prompt appears to enter in a description of the new custom specification.



### Adjustment Animations

Illustrations of adjustments specific to the selected vehicle can be viewed by clicking on the “wrench” icon to the right of the specifications field. Animations are also accessible from the readings screens. An animation of the adjustment procedure will appear on the screen. Animations can be paused, stopped and restarted at the operators preference by using the controls at the immediate bottom of the animation screen. Select “OK” or “Cancel” to return the operation to the current screen.

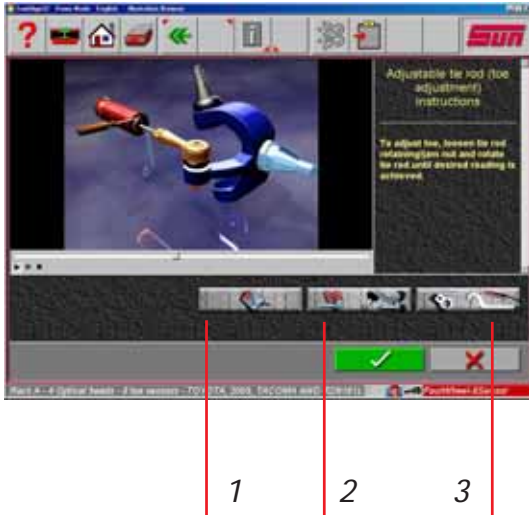

**Additional Assistance**

Included to the right of the animation window is a text box with three types of information regarding the current alignment adjust procedure. Information is requested by clicking on the icon associated with the assistance. These icons are:

**1-Adjustment Instructions** - Selecting the first of three function buttons on the Animation screen provides adjustment instructions.

**2-Parts Required** - The center selection displays parts required to complete the alignment process, such as shims, eccentrics or other aftermarket supplied parts. The displayed parts are linked to the selected shim manufacturer setup in the “Preferences” section.

**3-Special Tools** - The third icon button displays any special tools that may be required to perform the alignment properly.



**Enter Customer Data (Advanced Feature)**

The optional Customer Database feature, when activated, allows entry of information about the customer and his vehicle. With the database this information can be saved for later recall. In addition, this information is stored along with the results of the wheel alignment service.

A *database* is a collection of information to be sorted and retrieved as needed for analysis. Available information includes the car owner’s name, address, phone number; the vehicle make/model/year, VIN number, and mileage; plus the date of service along with before and after alignment readings. This information is stored on the computer hard drive for later retrieval. Once retrieved, the information can be reviewed and can become the starting point for a new alignment.



**Adding Customer Information**

Using the pointing device or TAB key to move around each of the text blocks, the operator enters information about the customer and his vehicle using the keyboard. Selecting OK will save the record to file for later retrieval.

**Selecting a Stored Record**

Stored or existing records can be sorted and retrieved in several different ways – drill down through data records, sort alphabetically by last name, by telephone number, and by vehicle license plate number. Once a record is visible, clicking on the plus sign expands the list to bring up a particular data set. Another way to find a record is to select the first letter of the customer’s name and highlight it using the pointing device. Double click with the left button when the desired record is highlighted. The complete record will be displayed with stored data.

	Left	Cross	Right
<b>Front</b>			
Caster	2.9°	0.1°	3.0°
Camber	0.1°	0.0°	0.1°
Toe	0.05°	0.10°	0.05°
SAI	0.0°	0.0°	0.1°
Included Angle	0.1°		0.1°
Toe Out On Turns	-20.0°		-20.0°
Max Turn	35.5°		35.5°
Setback		0.0°	
Ride Height		0.0°	
<b>Rear</b>			
Camber	-0.3°	0.2°	-0.1°
Toe	0.15°	0.25°	0.10°
Thrust Angle		0.0°	
Setback		0.0°	
Ride Height		0.0°	

**Recalling a Previous Alignment**

Once a particular record under the customer is chosen, the results of that previous alignment are recalled using the “Recall” button (F11) on the toolbar. The first screen that appears is the specifications of the vehicle that was aligned. Pressing OK brings up the Inspection Screen so that any inspected items can be reviewed. Pressing OK from here brings up the alignment readings in the “All Readings” format. The displayed values can be toggled from the initial to final readings using the Toggle button (F9) on the toolbar.

**Adding a New Customer**

Clearing all information on the data window can enter a new record. Selecting Clear Fields on the toolbar (F7) clears information. Once the screen has been cleared, enter the new customer information as desired. If another record is desired for an existing customer, highlight his name as using the pointing device, and begin entering information at the blank screen.

### Editing an Existing Record

An existing record can be edited by selecting the desired customer record. Once the record is displayed, move between information fields with the pointing device or TAB key. When the “I” bar is within the field to be edited, make the desired corrections. Data is saved when “OK” is entered.

### Using the Database Outside the Aligner Platform

The database is stored on the hard drive in a file called AlignmentData.mdb. This database file is compatible with several common database programs such as Microsoft® Access® (not supplied). See your office computer software representative for information regarding these programs.

### Inspection

Inspection reports are a valuable tool for the reporting of vehicle problem areas. Reports can be printed and retained for shop files or given to the customer to reinforce his comprehension of the work performed or the work necessary before an alignment can be performed. In many cases worn or damaged components will affect the quality of the wheel alignment.

A Wizard procedure can contain up to six vehicle inspection reports or lists. These lists can be selected within the Wizard process or they can be selected manually from the Main Alignment tab.

Areas to be inspected within each of the inspection forms are topically related. Any number of inspections can be utilized during the alignment process. The six inspection forms are:

- Pre-Alignment Inspection
- Tire Inspection
- Brake Inspection
- Under Car Inspection
- Under Hood Inspection
- Courtesy Inspection

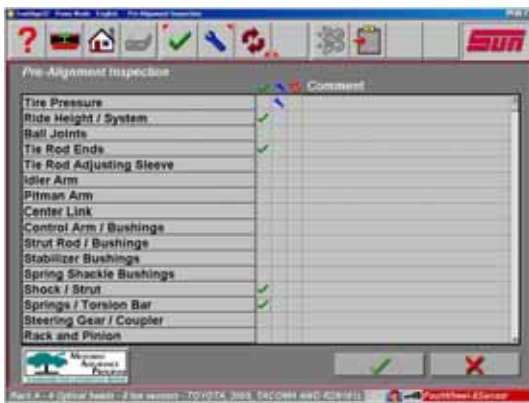

### Using Inspection Reports

All inspection reports require the same operating procedures, with the exception of Tire Inspection. When the desired inspection report is displayed, use the pointing device to select “Checked”, “Adjusted”, or “Replaced” in the column to the right of the component description. A comment relating to the component or repair can be typed in the space provided to the right by selecting Edit Comments on the toolbar (F8). After all inspections and comments have been made, choose “OK” to save these checks to the database and to the printer buffer for later printout. Selecting “Cancel” button takes the operator to the previous screen.



### Perform Runout Compensation

Compensating for the amount of runout of the wheel assemblies is an important factor in the alignment process. If not correctly determined, there will be errors in the displayed camber and toe angles. The aligner utilizes a runout procedure that calculates a true plane of the wheel assembly by measuring variations in toe and camber planes during a 360-degree rotation of the wheel.

To perform wheel runout, raise the vehicle wheels off the alignment rack surface using air jacks or other method to allow the wheels to rotate freely. An animation of how to perform runout is launched by selecting Animate on the toolbar (F5). Follow steps A through C carefully.

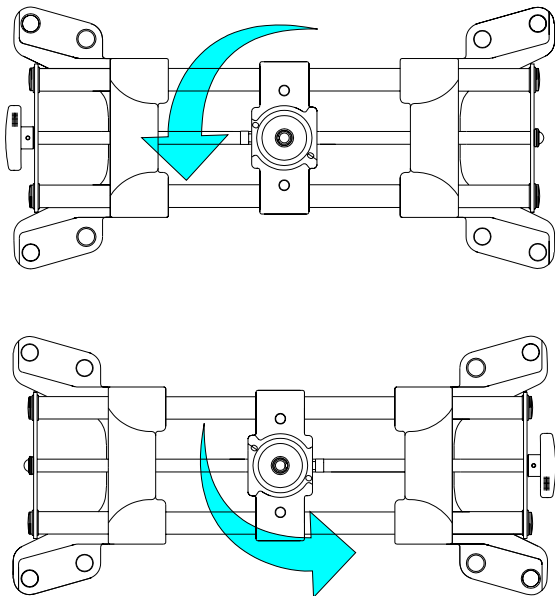

- A. Turn the wheel until the stamped-in number “1” is showing on the wheel-clamp center slide which is at the 9 o’clock position. Level the sensor, hold the assembly here and press the “Runout” key on the sensor keypad.
- B. Turn the wheel until the stamped-in number “2” is showing on the wheel-clamp center slide (180 deg) which is at the 3 o’clock position. Level the sensor, hold the assembly here and press the “Runout” key on the sensor keypad.

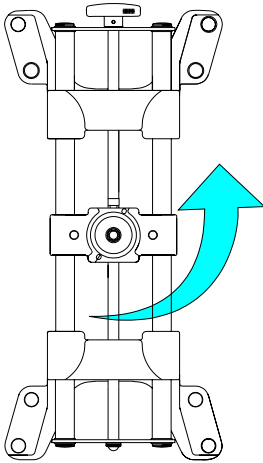

- C. Turn the wheel until the stamped-in number “3” is showing on the wheel-clamp center slide (90 deg) which is at the 12 o'clock or straight-up position. Level the sensor, hold the assembly here and press the “Runout” key on the sensor keypad.

After the first time the runout button is pressed a light will appear on the “Runout” key on the sensor, indicating the aligner is in the runout mode. As the runout key is pressed at position 2, the light will blink and a tone will sound from the console.

At position 3 the light will blink and then go off, indicating the runout process is complete for that wheel. If the runout indicator light does not go out after step 3, something has gone wrong. Press the runout key until the light goes out, then repeat the complete the 1-2-3 runout steps for that wheel.

Repeat the above steps for all wheels.



**Runout Status**

The Runout screen shows the status each wheel of the vehicle. As runout is successfully completed each wheel turns to a green color and display “OK”. If a moderate amount of wheel runout is detected (.75°-1.5°), but not enough to influence the alignment results, a “?” will appear and the wheel indicator will turn yellow. It is acceptable to continue at this point. If a high amount of runout is detected (above 1.5°), a red universal “Cancel” will appear on the wheel indicator. This problem must be corrected prior to proceeding. Incorrect wheel clamp mounting, a bent clamp, a bent or loose wheel, or a problem inside the measuring sensor can cause excessive runout.



***More Information on Runout***

Here are some important notes regarding runout compensation:

- If “two sensors” has been selected in the System setup, only two wheels will be shown.
- Runout can be completed or updated at any time and from any screen in the aligner. It is not necessary to start over if runout needs to be taken again. Any time a wheel is removed from the vehicle, or the clamp is removed from the wheel, runout compensation must be repeated on that wheel only.
- The wheel clamp must remain in the straight up position (#3) at the end of the runout procedure. Do not rotate the clamp away from straight up for any reason. Be careful of many rear wheel and 4 wheel drive axles where turning one raised wheel causes another to move.
- Do not skip or shortcut the runout compensation process in any way. It is an important part of obtaining accurate alignment angles.

After runout compensation is completed on all the aligner is ready to measure the vehicle’s wheel alignment angles, beginning with caster. Click on the OK button to proceed.



***Lower Wheels and Bounce (settle) the Suspension***

The next screen that appears instructs the technician to lower the wheels and bounce or settled the suspension so the vehicle sits at a true ride height. Slip plates should be utilized to provide the necessary side-slip required to return the vehicle to its normal resting position. When lifted, a vehicle’s suspension and steering components are placed in an unloaded condition. If not bounced or allowed to settle when lowered, this could skew the readings results. Click on “OK” to proceed.

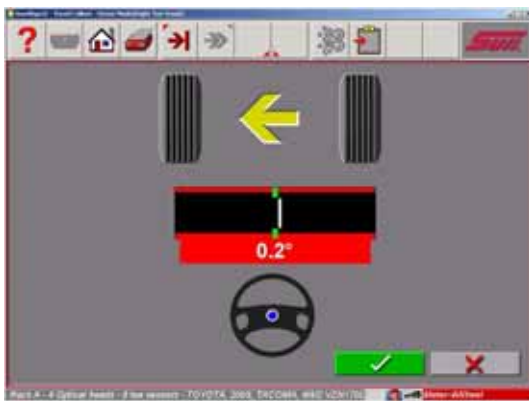

***Center the Steering***

If the front wheels are not facing straight ahead, the first step of the caster sweep directs the operator to steer as needed. While viewing the on the screen meter, center the steering as instructed.

***Perform Caster Turn***

The caster angle is measured by moving through a 20-degree turn of the front wheels. The software guides the operator through the steps on-screen. The caster sweep screens show a graphic of the wheels with the direction they should point, an arrow to indicate the turn direction, and a steering wheel graphic indicating the turn direction. Always follow the arrow direction and hold the wheel steady until the wheel turns green and the screen advances.

***Automatic or Manual Caster Sweep***

Automatic caster sweep is used in most situations, using the sensors’ infrared optics system to accurately measure 10 degrees and then automatically progressing to the next step. If the automatic mode cannot be used for any reason, the system can be switched into the Manual caster sweep mode where turntable scales are used to determine 10 degrees and the OK button is pressed to move to the next step. The Automatic/Manual mode is selected anytime during the caster swing procedure by selecting the Tab button on the toolbar (F5). The active selected mode will be indicated in the top left of the display.



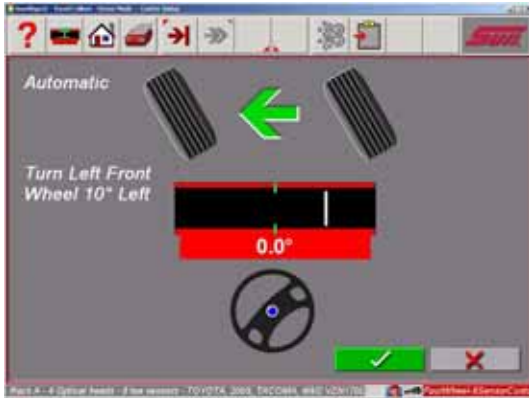

**Turn to 10 Degrees Left**

After starting out with the front wheels facing straight ahead, the screen will change to indicate a turn to 10 degrees left. As the turning angle nears 10 degrees the wheels will change from gray to green meaning the measurement has been taken.

**Turn to 10 Degrees Right**

The screen then changes to indicate a turn past straight-ahead to 10 degrees right. The “wheels” will behave as above as the 10 degree angle is approached. The wheel graphics change to green as the measurement is taken.

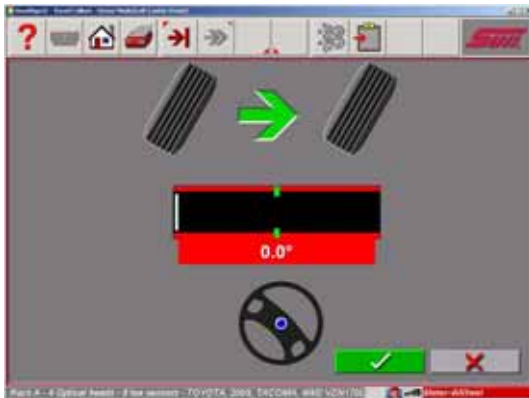

**Turn Wheels Straight Ahead**

The screen then changes to indicate turning the wheels to the straight-ahead position. Centering the steering allows the geometric centerline to be established for the rear readings that in turn will determine the thrust angle or rolling direction.

Once these steps are completed, caster is measured and the software moves to the readings screens.

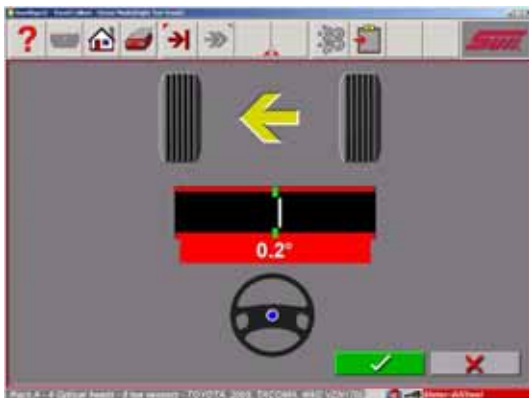

**Information about Caster Accuracy**

There are a number of reasons why caster measurements may vary when repeated:

- Pulling/pushing the wheel differently – these variations can be minimized by utilizing a brake pedal depressor during the caster sweep to ensure the wheels do not roll or rock during the turns. In addition, utilizing the steering wheel to make the turns minimizes the operator influence.
- Failure to reach the 10 degree mark exactly and hold steady until the measurement is taken
- Vehicle suspension / steering variations – if the vehicle has play or looseness in suspension and/or steering components, this can affect the reaction and tilt of the wheel during turns.
- Turntable / Rack condition – the condition of the turntables is critical. They must be free moving and flat with all bearings in place. Also, center the vehicle wheels on the turntables to ensure flatness during the turn.

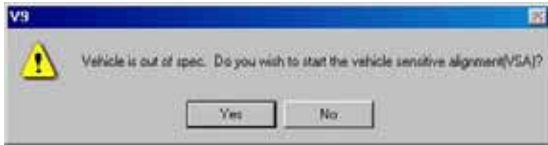

### Vehicle Sensitive Alignment (VSA)

If “Vehicle Sensitive Alignment” is activated in the preferences menu, the message to the left will appear. Select “Yes” if this feature is desired or “No” if standard alignment procedures are desired. The “VSA” feature in most cases will speed the alignment process by skipping procedures not required for completion of the alignment.

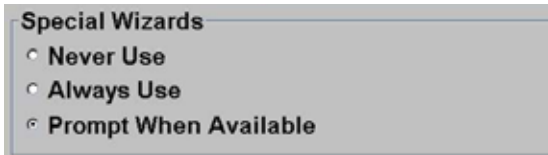

The VSA procedure is activated by selecting “Prompt When Available” on the “Features” menu, under the Preferences tab. See illustration to the left.

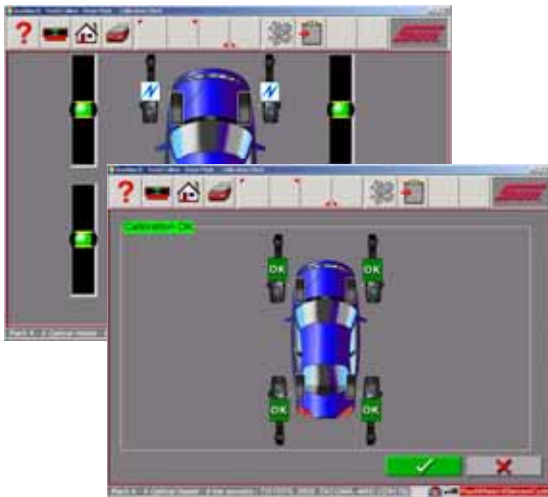

### Calibration Check

Each time the aligner is operated it checks itself against a preprogrammed set of parameters and determines if the machine accuracy has been compromised. First, all measuring sensors must be level. A screen indicates which sensors require attention. Once level is achieved on all four sensors, a verification screen indicates which, if any sensors exceed calibrated parameters. This feature will warn the operator if readings will be affected if a sensor has been dropped or damaged.

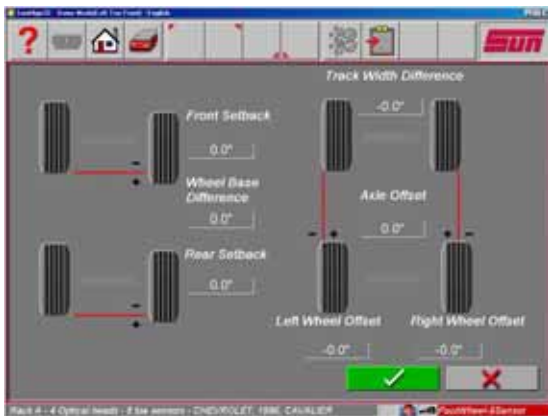

### Vehicle Dimensions / Setback

The results of the 8-sensor vehicle dimensions measurements are displayed with a visual reference to a vehicle depicting wheelbase difference, trackwidth difference, and front and rear setback. Setback occurs when one wheel on an axle is not even with the other.

Setback and vehicle dimensions are useful measurement tools to diagnose vehicles that may have been involved in a collision.





### All Readings

This is a screen that shows both the rear and the front readings at the same time, giving the ability to evaluate the vehicle's total alignment status. If vehicle specifications have been entered, the numeric displays will be red (out of specification) or green (within specification). Front and rear camber and toe readings are live on this screen allowing for adjustments to be made. In addition, this screen is where the vehicle's diagnostic angles, if measured, are displayed. These angles are Included Angle, SAI, Toe Out on Turns, and Setback. Click on the scroll bar to the right of the screen to view the diagnostic angles for the front and rear.



### Rear Readings

After *All Readings*, the *Rear Readings* screen appears. This screen displays, both in meter and numerical format, the angle measurements and information needed to determine if corrections are necessary. The display is divided into three rows: **Camber**, **Toe** and **Thrust Angle**. The columns represent the left and right side of the vehicle. The Camber and Toe meters have minimum and maximum specifications along the top, a numeric readout of live readings, and a color coding to indicate the relationship of live values to specification. Grey meters indicate no specification has been entered for this angle. Red meters indicate the angle is beyond manufacturer's specification. Green meters indicate the live values are within the specification. Elevated readings can be viewed by selecting the "Jack" icon located right of the cross values.

### Cross Values / Total Toe

The numeric value between the camber meters indicates cross values (side-to-side), the difference between left and right readings. This cross value is important on many vehicles for proper handling. The numeric value between the left and right toe meters indicates the rear Total Toe (the sum of individual toe).

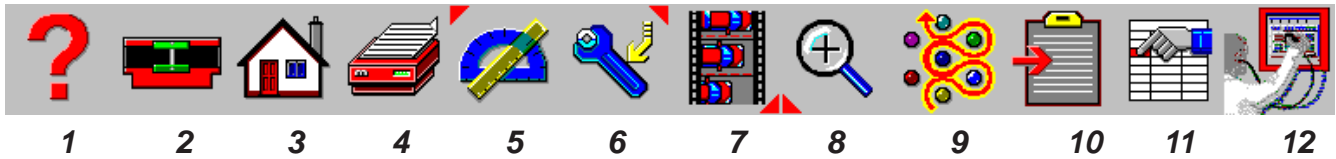

### **Readings Toolbar**

Toolbar buttons available on both front and rear Readings Screens from left to right are:

- F1 Help – displays operation assistance for the screen presently open
- F2 Meters - takes the user directly to “Readings”
- F3 Home – returns the software to the opening Home Alignment tab
- F4 Print – accesses the print report menu
- F5 Measure – access to measuring additional angles
- F6 Adjust – access to assistance for the technician with angle corrections
- F7 Animate – assists the technician with illustrations of each angle adjustment
- F8 Zoom – brings any meter to full screen size to aide viewing
- F9 Wizards - change wizards
- F10 Login – user Login or Logout
- F11 Edit – allows editing of the vehicle selection, specifications, customer information, and inspections within the current alignment
- F12 Setup – allows alteration of any setup item on the Preferences tab

**NOTE:** If a toolbar button is “*grayed out*” it means the function is not available on that particular screen.



### Level and Lock Steering Wheel

Before front readings are displayed it is necessary to level the steering wheel and lock it in place using the steering wheel holder. In addition, all measuring sensors must be leveled and locked in place. Press “OK” to move forward.

When the aligner software prompts the operator to level the steering wheel, the vehicle’s thrust angle is determined. Thrust Angle is the direction of the vehicle travel determined by the total toe of the rear wheels. The thrust angle is used as a reference when adjusting the front toe so that a straight steering wheel is the end result. Toe error on many rear wheel drive vehicles cannot be corrected, creating a dog tracking effect and/or a crooked steering wheel.



### Front Readings Screen

The Front Readings screen is similar to the rear. Caster is displayed with the top meters. Note this reading is represented by an icon showing the caster reading to be “frozen”, since caster is not a live reading. Camber meters are located in the middle of the screen and toe meters are at the bottom. Camber and toe are “live” displays which can be referenced while making adjustments. When measurements are within specification, the center portion of the meter is green. If red is displayed, the readings are outside of specifications. Grey meters indicate this angle has no specification. Elevated readings can be viewed by selecting the “Jack” icon located right of the cross values.

*Cross Values / Total Toe* – the numeric value between the caster and camber meters indicates cross values (side-to-side), the difference between left and right readings. This cross value is important on many vehicles for proper handling. The numeric value between the left and right toe meters indicates the front Total Toe (the sum of individual toe).

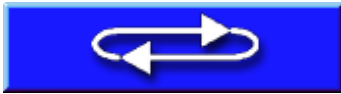

**Loop Button**

There are three “Readings” screens within the software – All Readings, Rear, and Front Readings. These three screens can be “looped” from the Front Readings screen. When the Front Readings screen is displayed, the Rear and All Readings screens are retrieved by pressing the “Loop” button located at the lower left corner of the screen.

**Zoom**

For a full screen zoom image of any one meter move the white highlight box with the arrow keys, and then select Zoom on the toolbar F8. Click on button F8 again to return to the full screen display (unzoom). Double-clicking on any meter will also zoom/unzoom them. It is possible to move around to other meters while zoomed by using the arrow keys on the keyboard and sensor keypads.

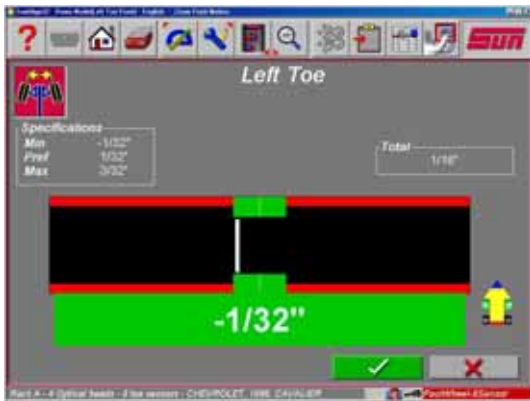

**Print Results**

Select Print on the toolbar (F4) on either the Front or Rear Readings screen to go to the Printer Menu screen. The options are:

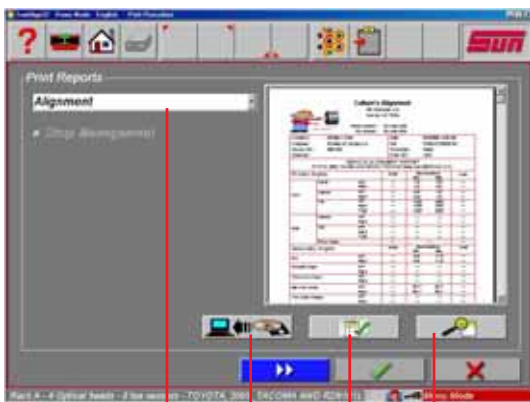

1    2    3    4

**1-Select Desired Alignment Report** - Select the desired type of report to be printed from the drop down box

**2 - Import from a disk** - This selection allows a customized report or logo to be imported to the system directory. Custom reports must be created by Crystal Reports\* by the user or authorized agent. A custom “BMP” logo can be imported as well.

**3 - Set Default Report** - Determine the desired report to be used as default and for one click printing.

**4 - Zoom** - Select this button to enhance the size of the displayed report. Click OK to continue printing or Cancel to go back to the print menu.

\* Not included with aligner software package



## Inspections

Inspections are typically part of the Wizard process, or can be selected from the Home Alignment tab by clicking on the Inspection icon. In addition, Inspections can be accessed during the alignment from the readings screen by selecting the “Edit” button (F11) on the toolbar. The single icon on the right side, Vehicle Dynamics, accesses the diagnostics functions of the aligner.



## MAP

The MAP button, located on the lower left of the Inspection screen, launches vehicle inspection and repair information from MAP, which stands for Motorist Assurance Program. This information provides guidelines for the automotive service industry on how to diagnose faulty components and the proper ways to explain the needed repairs to the vehicle owner. This is a valuable tool for the industry that has been widely accepted throughout North America.



## Vehicle Dynamics

If additional assistance is required to repair or diagnose an alignment problem, the technician has several options that he can exercise. Diagnostic procedures are available automatically when programmed into a Wizard or they can be accessed when needed during an alignment.

From the Inspection screen, click on the Vehicle Dynamics icon to bring up the Vehicle Dynamics screen. Two icons are available – Manual and Automatic Diagnostics.





### Manual Diagnostics

Selection of Manual Diagnostics activates a series of screens in which the operator is asked questions to assist the technician in diagnosing the vehicle's problem. When all questions have been answered, suggestions in resolving the problems are made.

Four complaints are covered – *Pull, Unlevel Steering Wheel, Vibration, and Treadwear.*

### Automatic Diagnostics

Selecting Automatic Diagnostics activates a routine that utilizes measured angles, compares them to vehicle specifications, then makes a determination of a vehicle's potential problem. This feature is useful for educating the technician and vehicle owner on what vehicle problems are created when alignment angles are out of specifications. The screen shows the expected vehicle problem for caster, camber, and toe on the left and right wheels.



Note: The operator must measure SAI and must enter specifications before an automatic evaluation can be made. If these Diagnostics screens are made part of the alignment path using a Wizard, it is recommended to configure the "Alignment Order" to measure Caster/SAI simultaneously instead of caster only.



### Bent Parts Diagnosis

SAI, Included Angle, and camber have been used manually for years to diagnose bent parts. This technique has been incorporated into the software utilizing the power of the computer system. Angles are measured and compared with vehicle specifications to determine if a problem exists. An on-screen readout informs the technician which components are most likely bent or damaged, categorized by suspension designs.



## Measure

When the Measure icon is selected from the Main Screen or from the toolbar on any readings screen, a screen appears that allows the operator to measure any wheel alignment angle.

**1-Caster Only** – used to update the caster value by re-sweeping the wheels through the 20 degree turn.

**2-Caster and SAI on Turntables** – measures both the caster and steering axis inclination (SAI) angles simultaneously by sweeping the wheels through the 20 degree turn. This is done on the turntables (loaded suspension)

**3-SAI Only Elevated** – measure the SAI angle only, with the wheels elevated (unloaded)

**4-Camber at Zero Toe\*** – a routine that forces measurement of camber with each individual wheel in the straight ahead (zero toe ) position. Recommended for vehicles with high caster values

**5-Vehicle Dimensions** – provides additional information about the condition of the vehicle’s frame, such as setback. With the optional 8-sensor measurement package, additional information, such as trackwidth difference, is displayed

**6-Toe Out On Turns** – measure the difference in turn angles of the front wheels at 20 degrees (toe out on turns)

**7-Maximum Turn Angle** – measure the maximum angle each front wheel will turn

**8-Toe Curve Measurement\*** – measure the individual wheel toe change as the suspension goes through bounce and rebound

**9-Ride Height Measurement\*** – measure the vehicle ride height

*\* These Measurements are Premium Features*

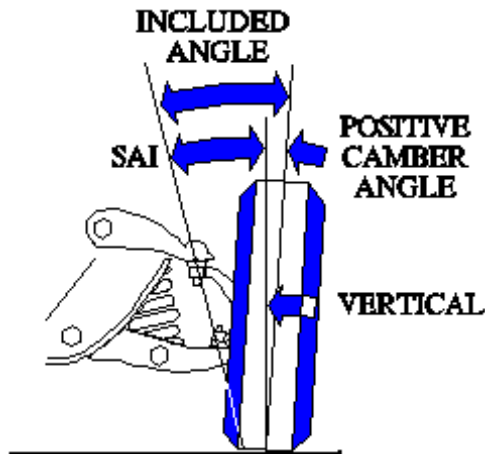

### Steering Axis Inclination (SAI) and Included Angle (IA)

These angles are powerful tools in diagnosing bent or damaged suspension parts. A bent spindle, control arm, strut, frame mounts, or a cradle shift problems can be identified. SAI is measured either vehicle weight loaded on the turntables or with the front wheels elevated. Included Angle is not actually an angle defined on the vehicle – it is a mathematical formula. By definition,  $IA = SAI + CAMBER$ . Most late model vehicles have a specification for Included Angle, and a few for SAI. Compare the measured values to spec, but also compare side-to-side (cross) differences.

Note: Cross differences for Included Angle should not exceed 1 to 1.5 degrees for most vehicles. If a high cross value is discovered, it may be creating a pull condition. Generally, the damaged part is on the side with the lower IA reading.



### Measuring Steering Axis Inclination (SAI) and Included Angle

The measurement method for SAI and Included Angle is similar to the Caster measurement. The wheels are turned through a 20 degree turn and the change in wheel tilt is measured. SAI can be measured either on the turntables (loaded) or with the front wheels elevated (unloaded). The results of loaded or unloaded will be similar, but some variation may occur due to the type of vehicle suspension. When measured on the turntables, caster is also measured. For accurate results follow the on-screen instructions carefully.

1. Whether measuring SAI on the turntables or elevated, it is mandatory to lock the vehicle's brakes. Start the car to initiate the power brakes and install the brake pedal depressor between the seat and the brake pedal.
2. Level and lock the measuring sensors on the wheel clamps using the locking knobs.



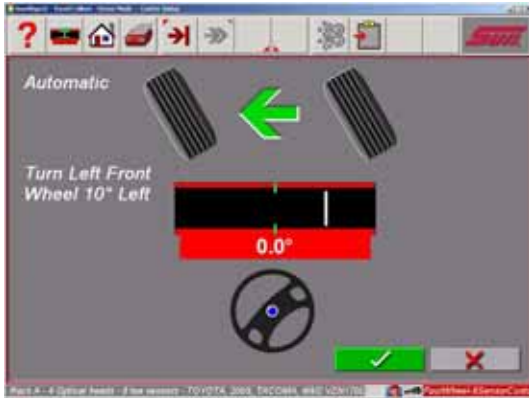

3. Follow the on-screen instructions. During the elevated measurement, the instruction say to raise the front wheels using rigid supports. This is typically done with a jack included with the alignment lift.
4. The turning sequence is identical to the process for obtaining caster values.
5. When measuring elevated SAI, the final instructions will be to lower the vehicle and bounce the suspension.
6. The SAI and Included Angle values are displayed on the All Readings screen. Caster is displayed on the All Readings screen as well as the Front Readings meter screen.
7. Use SAI and Included Angle to diagnose a handling problem or a bent part that is limiting the adjustment of camber.

Note: Not all vehicle manufacturers publish specifications for SAI or Included Angle. All available manufacturers' specifications are included in the aligner database.

### Camber at Zero Toe

This routine measures camber on the left and right front wheels individually at zero toe. This is the recommended procedure for vehicles with high caster specifications, such as Mercedes-Benz.

The procedure is as follows:

1. Select Camber at Zero Toe from Measure Screen
2. Using the on-screen meter, turn the left wheel towards the center until the meter turns green
3. Press OK to continue
4. Repeat this process for the right wheel. Click OK to continue
5. The software returns to the readings screen

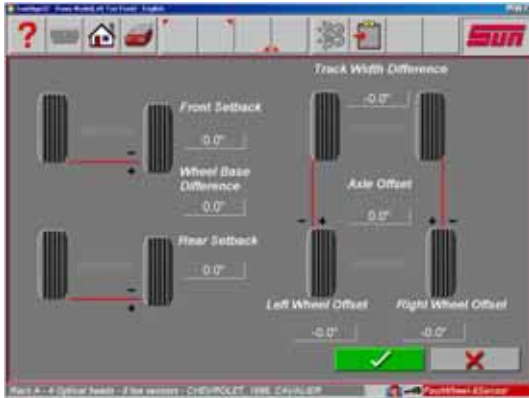

### Vehicle Dimensions / Setback

Setback and vehicle dimensions are useful measurement tools to diagnose vehicles that may have been involved in a collision. Setback occurs when one wheel on an axle is not even with the other. These measurements are accessed from the Measure toolbar button on the Front or Rear Readings screens, or from the Measure icon on the Home Alignment tab. In addition, Vehicle Dimensions can automatically appear in the alignment path if this feature has been set up in the Wizard procedures. On-screen instructions must be followed carefully.

The results of the 8-sensor vehicle dimensions measurements are displayed with a visual reference to a vehicle depicting wheelbase difference, trackwidth difference, and front and rear setback. In addition, setback values are displayed on the All Readings screen and are printed during the alignment results printout. Vehicle dimensions and setback can be displayed in inches or millimeters, selectable in the Units setup.

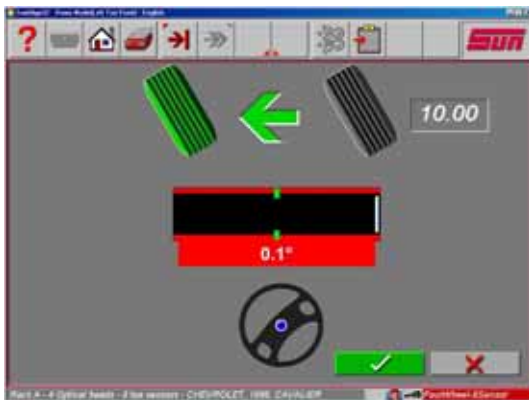

### Toe-Out-On-Turns (or Turning Radius)

Toe-out-on-turns is another diagnostic measurement that is valuable in troubleshooting steering and handling problems.

**TOOT** or turning radius, as it is commonly called, is the difference in the turning angle between the inside and the outside wheel.

On many vehicles, the manufacturer specifies the inside wheel to be turned 10 then 20 degrees.

Note: The vehicle database does not contain specifications for toe-out-on-turns. Refer to an alignment specification book or the vehicle's shop manual.

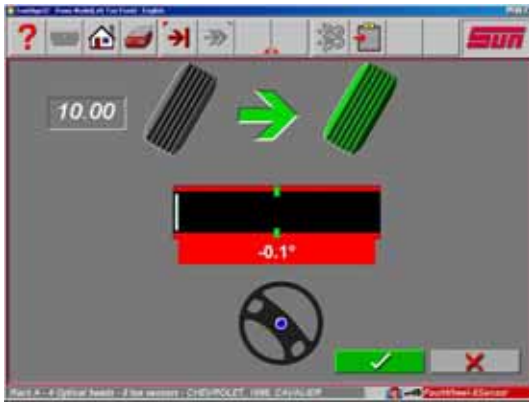

The Toe-Out-On-Turns measurement entry is automatic using the CCD toe imaging sensors. Some systems may also be equipped with optional Electronic Turntables for extended range.

Turn the inside wheel to the reference angle as indicated by the scale, the values are entered into the computer automatically when OK is selected. When a turn is made to the left, the driver side wheel is the inside wheel and the passenger side is the outside wheel. Repeat these steps for a right-hand turn. The diagnosis of a problem is always made on the outside wheel of the turn. For best results follow the screens carefully. Once completed, the TOOT results appear on-screen in a chart format and are available for printout. To review the TOOT values later in the alignment, go to the All Readings screen.



Note: Toe Out on Turns problems indicate a bent or damaged steering arm, with the problem wheel being the one on the outside of the turn.



### Maximum Turn Angle

This routine is very similar to the Toe Out On turns feature. It allows the measurement of the “full lock” or maximum turn in each direction. It uses the turntable scales and provides the ability to enter the results in the computer for viewing and printing. Consult an alignment specification manual or shop service manual for manufacturer specifications for the maximum turn reference angle and the outside turn value. Entry of these values is accomplished by clicking on the up or down arrow button next to the numeric window until the desired value is obtained.

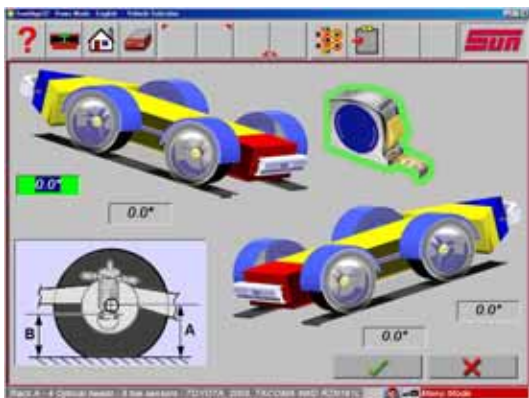
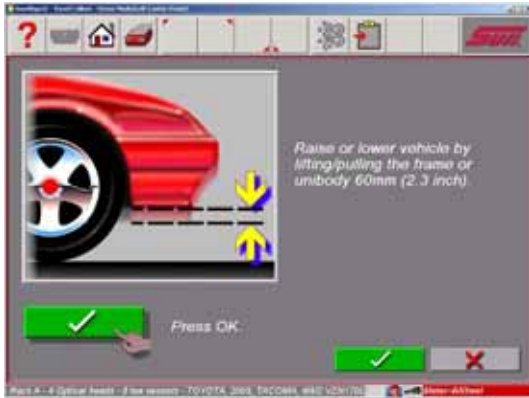

### Toe Curve Change

This feature allows measurement of individual wheel toe change as the suspension system goes through bounce and rebound (spring compression and expansion). An excessive amount of toe change can cause premature tire wear. A large change on only one side can cause “bump steer”, a dangerous condition causing the vehicle to rapidly change directions when bumps are encountered. While there are no specifications for the amount of change, it should be fairly small, and a comparison of left and right wheels can assist in diagnosing defective steering system components. Follow the on-screen instructions carefully to move the suspension through a 60mm (2.3”) travel. Pulling down or pushing up the suspension can do this. Use a ruler or tape measure to observe the proper amount of frame movement. Select OK when completed to display the results.

Note: On cars with rack and pinion steering, a bump steer condition is usually created by worn rack mounting bushings that allow the entire rack to shift when bumps are hit. Some cars have slotted idler arm mounts to allow correction of toe curve change problems.

### Ride Height

The alignment of many vehicles are dependent on a ride height measurement. Variations in ride height may alter desired specifications. Examine the vehicle and determine the proper method of ride height measurement. Highlight the measurement method displayed for both front and rear. Press “Enter”.

Input the measured values into the provided spaces to record into the database

Many vehicles may not have manufacturers ride height specifications, however the side to side and front to rear relationship can be measured and compared to diagnose a potential problem.

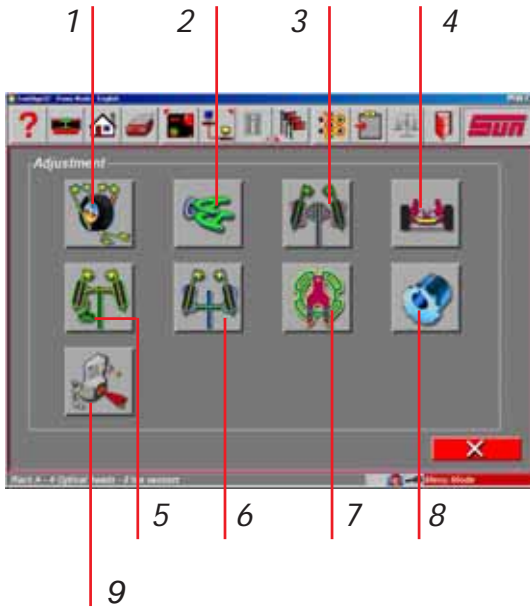

## Adjust

One of the most powerful features of the software is assistance given to the alignment technician when performing adjustments on a vehicle. These features are on the Adjust screen, and are accessed through the Adjust icon, located on the Home Alignment screen and from the Adjust button on the toolbar when alignment readings are displayed.

There are numerous features designed to improve the efficiency and affectivity of the alignment technician. Icon choices are from the Adjust screen are explained below:

**1-Caster and/or Camber** – several different options available to assist with these angles, including live caster and elevated modes

**2-Adjust A-arms** – for vehicles whose caster and camber adjustments are located on the suspension A-arm, this selection allows both angles to be corrected simultaneously

**3-EZ Toe\*** – this software routine is a new and improved method of setting front toe, making it easier to obtain straight steering wheels

**4-Cradle Adjust\*** – assist with the adjustment of the engine cradle on many front wheel drive cars

**5-Drag Link Adjust\*** – assists with steer direction and straight steering wheel when performing toe adjustments on trucks with a drag link adjustment

**6-Single Tie Rod Adjust\*** – helps with vehicles having a single tie rod toe adjuster

**7-Shims and Kits** – many front wheel drive cars use a shim on the rear axle/spindle to adjust camber and/or toe. This program determines the proper shim to use

**8-Front Shims and Kits** – used on many 2 and 4 wheel drive trucks to calculate proper size and orientation of offset bushing or sleeve

**9 - ADR Adjustment\*** - The aligner can be used in conjunction with VAS 6141 to align the ADR sensor to the vehicle thrust line.

**\* These Adjustments are Advanced Features**



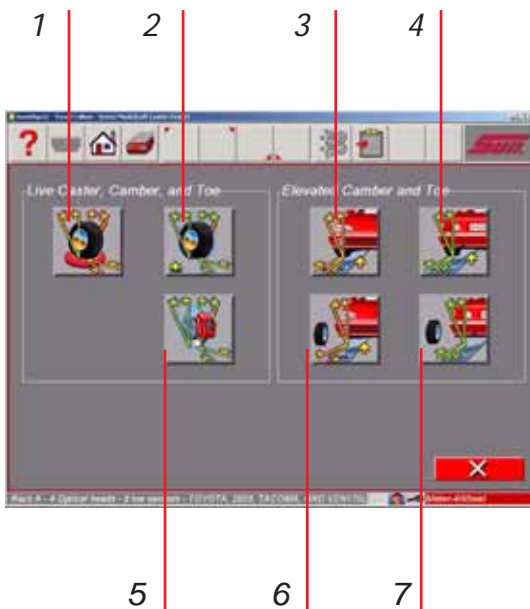

### Live Caster, Camber and Toe

These selections access methods of adjusting caster, cameber and toe with live readings. The user selected icon will depend on the type of adjustment being made and the type of vehicle suspension.

#### 1- Adjust Caster, Camber, Toe on Turntables –

Caster, camber and toe adjustments can be made with the suspension loaded, such as cams on a McPherson strut for camber or strut rods for adjusting caster. In this mode, the wheels remain on the turntables and caster is a live reading.

#### 2- Adjust Caster, Camber and Toe Elevated –

The weight of the vehicle may keep the adjustment from being made easily, such as moving the upper strut mount. In this mode, the wheels are elevated and caster is a live reading.

#### 3- Adjust Caster, Camber, Toe Wheel Off -

This selection is like selection (2) above except the operator is given the choice of mounting the measuring sensor directly to the brake rotor for easy access to adjustment components. Refer to page 3-3 for more information.

### Elevated Camber and Toe

#### 4- Adjust Front Camber and Toe Elevated –

this mode is used for adjusting camber and toe on the front wheels. The readings on the turntables are retained even though the wheels are elevated.

#### 5- Adjust Caster, Camber, Toe Wheel Off -

Same as above but with the *Wheel-off* option.

#### 6- Adjust Rear Camber and Toe Elevated –

this mode is used for adjusting camber and toe on the rear wheels. The readings on the turntables are retained even though the wheels are elevated.

#### 7- Adjust Caster, Camber, Toe Wheel Off -

Same as above but with the *Wheel-off* option.

### Adjust Caster and/or Camber, Toe on Turntables

After selecting this icon, instructions appear in preparation for the adjustment.

1. Bounce the suspension
2. Install brake pedal depressor
3. Level and lock the heads.



**WARNING! FOLLOW ALL ON-SCREEN INSTRUCTIONS CAREFULLY. INCORRECT ADJUSTMENT READINGS ARE POSSIBLE IF THESE STEPS ARE IGNORED.**

When OK is pressed, a screen very similar to the standard Front Readings display appears. The major difference is the caster reading – it is live instead of frozen. Caster and camber can be adjusted while viewing this screen – for example, caster change will be shown as a strut rod is lengthened or shortened.

As the adjustments are made, the meter movements and numeric values change. The meters are color coded to show their relationship to specification. This screen is useful for vehicles with independent adjustments where one adjustment causes the other angle to change (i.e. Mercedes Benz and Lexus).



Once the adjustments are completed, press OK.

1. Unlock the brakes
2. Unlock the sensors
3. Press OK

The software returns to the Caster and/or Camber selection screen. Select the Cancel button to return to the meter screens.



## Adjust Caster, Camber and Toe Elevated

After selecting this icon, instructions appear in preparation for the adjustment.

1. Bounce the suspension
2. Install brake pedal depressor
3. Level and lock the sensors
4. Press OK
5. Raise front wheels using rigid supports
6. Press OK

---

**WARNING! FOLLOW ALL ON-SCREEN INSTRUCTIONS CAREFULLY. INCORRECT ADJUSTMENT READINGS ARE POSSIBLE IF THESE STEPS ARE IGNORED.**

---



When OK is pressed, a screen very similar to the standard Front Readings display appears. The major difference is the caster reading – it is live instead of frozen.

Adjust caster and camber while viewing this screen – for example, camber and caster change will be shown as an eccentric cam is turned. As the adjustments are made, the meter movements and numeric values change. The meters are color coded to show the readings' relationship to specification.



Once the adjustments are completed, press OK. Post-adjustment instructions will be displayed.

1. Lower wheels. Bounce suspension
2. Unlock the brakes
3. Unlock the sensors
4. Press OK

The software returns to the Caster and/or Camber selection screen. Pressing the cancel button from there returns to the meter screens.







### Adjust Front Camber Elevated Adjust Rear Camber Elevated

For either the front or rear wheels, this feature allows the wheels to be elevated while retaining the measured camber values. This gives the ability to make accurate correction of camber without vehicle weight inhibiting the adjustment process. This would be useful for tapping down a wedge on a strut vehicle.

The adjustment screen displays live camber meters and numeric values for the left and right wheels along with live toe values. Make the desired adjustments while viewing the meters. When completed with the adjustment, press OK. Post-adjustment instructions are displayed.

1. Lower wheels
2. Bounce suspension
3. Press OK



The software returns to the Caster and/or Camber selection screen. Pressing the cancel button from there returns to the meter screens.





## Adjust A-arms

Many vehicles have adjustment provisions for caster and camber located on the suspension A-arm (control arm), either on the upper or lower arm. The adjustments may be made with shims, eccentric cams, or slots in the frame. Both angles are easily corrected to manufacturer's specification using the Adjust A-arm icon.

The first step is telling the aligner the location of the adjustable A-arm and whether the corrections will be made on the turntables or elevated. This is accomplished by pressing the proper icon on the Adjust A-arm screen. The icons are:

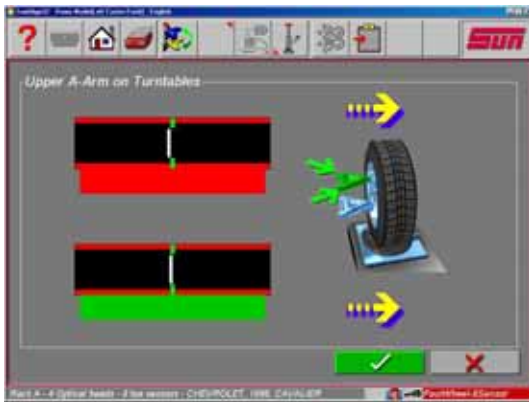

### Caster/Camber Adjustment on *Upper* Arm Caster/Camber Adjustment on *Lower* Arm

Examine the vehicle for the location of the adjusters. It does not matter whether the A-arms have shims, slots, or cams. Once the technician makes the decision, upper or lower, on the turntables or elevated, instructions appear apply the brake pedal depressor (important).

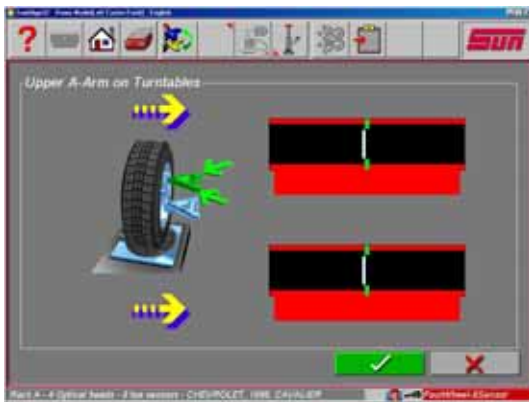

Next, a screen appears with a graphic of the right side A-arm along with two meters. These meters represent the movement of the front and rear of the A-arm, and their relationship to the desired readings. Move each side of the A-arm by adding/removing shims, loosening the bolts and sliding the arm, or turning the eccentric cams, until each meter indicator is centered in the meter – this is the desired value for both caster and camber. Press OK when this side is complete – a similar screen appears for the left side. When both sides are completed, press OK to return to the Adjust screen, and Cancel to go to readings.



## EZ Toe

This software routine is an improved method of setting front toe, making it easier to obtain straight steering wheels. It also makes it possible to adjust toe with the wheels turned left or right, an aide when setting toe on cars with firewall-mounted rack and pinion units.

Use the following procedures:

1. Perform all alignment steps normally used to obtain alignment readings. Correct any misalignment in the rear as well as front caster and/or camber.
2. Select the EZ Toe icon from the Adjust screen.

Note: DO NOT use the Steering Wheel Clamp during the EZ Toe procedure.



3. Level the vehicle steering wheel and the measuring sensors. Select OK.
4. Steer the right wheel to desired adjust position. Select OK.
5. The next screen shows a meter indicating the amount of toe change needed for the right wheel.



6. Adjust the right tie rod until the meter needle is in the green. Select OK after completion.
7. Follow the same procedures for the left wheel.
8. Select OK once the left toe adjustment is made.
9. Return to the Front Readings screen and recheck toe and steering wheel position.

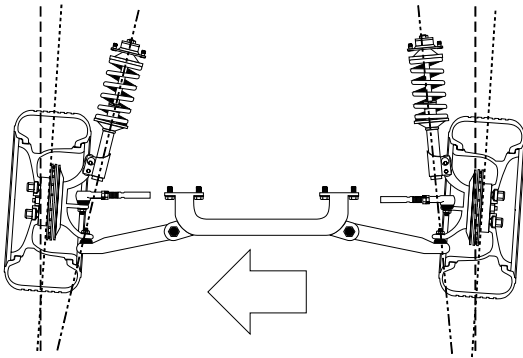

## Cradle Adjust

Cradle adjustment is a growing necessity for front wheel drive vehicles. Many front wheel drive vehicles are designed where the engine cradle also serves as the attachment point for the lower pivots of the suspension system. This assembly is bolted to the sub-frame as a unit from the bottom of the vehicle. The assembly must be properly aligned with the sub-frame to assure that front alignment is maintained.

A closer look shows that the lower control arms are bolted to the engine cradle. The control arm is attached to the spindle through the lower ball joint. The strut is attached to the top of the spindle and is then attached to the body via the upper strut mount to complete the suspension steering axis.

The engine cradle can potentially move side to side, changing the camber and SAI angles. Prior to beginning a cradle adjustment, examine the left and right camber values. If one side has excessive positive camber and the other side excessive negative, this vehicle is a candidate for cradle adjustment.

Vehicles with possible cradle misalignment include: Ford Taurus / Mercury Sable, Lincoln Continental, GM "W" Body (Lumina, Grand Prix, Cutlass, Regal), Chrysler "LH" Body (Intrepid, Vision, Concorde, LHS), Honda Accord, Acura Integra, Mazda 929.

Consult the specific vehicle service manual for details on how to loosen the engine cradle.

To adjust a cradle, click on the Cradle Adjust icon on the Adjust Screen. The Cradle Adjust screen has a graphic of the cradle with an arrow showing the direction of needed movement. A meter display determines exact placement. Loosen the cradle and slide in the direction of the arrow until the meter indicator is straight up – this is the ideal placement of the cradle. In addition, a live caster reading is shown for reference or for making a minor caster correction.

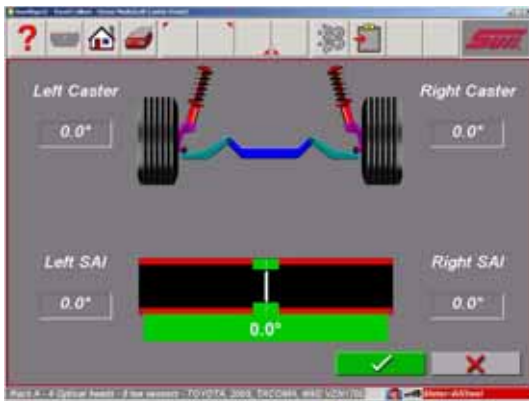



## Drag Link Adjust

The steering linkage on some 4-wheel drive trucks has a single total toe adjuster along with a drag link adjuster to correct the steering direction and straighten the steering wheel. The Drag Link Adjust feature allows simple and accurate adjustments to be made. From the Adjust Screen select the Drag Link Adjust icon.

The Drag Link Adjust screens displays a total toe meter and a steering direction meter. To make the proper adjustments use the following steps:

1. Steer the front wheels to equalize toe by bringing the lower meter into the green area. Click OK.
2. Adjust the single tie rod to the total toe specifications while observing the upper meter. Click OK.
3. Straighten and lock the steering wheel as prompted then click OK. Adjust the drag link sleeve until the steering direction is straight ahead, as indicated on the lower meter display.

## Single Tie Rod Adjust

Some vehicles, such as earlier Ford trucks and 80's Volkswagens, have a single tie adjuster for total toe, with no provision for adjusting for straight steering direction with a straight steering wheel. For these vehicles, click on the Single Tie Rod Adjust icon.

The screen that appears is similar to the Drag Link Adjust screen. Use the following steps:

1. Steer the front wheels to equalize toe by bringing the lower meter into the green area. Lock the steering wheel at this position.
2. Adjust the single tie rod to the total toe specifications while observing the upper meter.
3. If a straight steering wheel does not result, yet is desired, remove the steering wheel from the steering column (see factory recommended procedures prior to removing) and replace it as needed for a straight condition.



## Shims and Kits



Many front wheel drive vehicles utilize aftermarket shims to correct front and rear camber and/or toe. This correction is achieved by placing the shim between the rear axle and the spindle.



When a vehicle that utilizes rear shims is accessed from the specification database, the technician can use the *aligner* to determine the proper shim to correct a rear misalignment. From the “Adjust” screen choose the Rear Shims and Kits icon.

At this point the computer will examine the live rear camber and toe readings, compare them to preferred specification, and calculate the amount of change needed. It will then recommend the shim needed to make this correction. The screen to the left will be displayed.

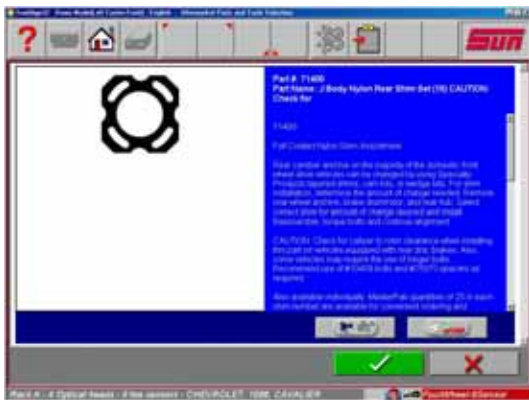

### Default Part Vendor

Determine the desired part vendor to select as the default aftermarket supplier. This selection will vary location to location and upon the Technicians preferences.



### INFO

The correct part number is automatically selected and displayed dependant on the vehicle selected and the amount of correction required.



Highlight one of the part numbers displayed, then click on the “Info” ICON to invoke a screen describing the correct orientation of shims or other corrective aftermarket parts. The “Info” ICON can be selected from several places of the screen. If highlighted, information is available. See sample screen at left.

Installation video and detailed Instructions may also be available.

Click the “Aftermarket Tools Available” ICON to view tools required for the specific procedure if available.





### Front Offset Cam Bushings

Many pickup trucks including Ford 2-wheel drive trucks and many Ford/GM/Dodge 4-wheel drive trucks utilize offset sleeves, cams or inserts around the upper or lower ball joints to adjust the caster and camber angles.

The program compares the current reading for caster and camber with the preferred specification, displaying the meters on-screen for reference. The required sleeve/insert to correct the angles is shown below the meters, along with the orientation of the slot. Proper orientation of the slot insures the correct amount of caster and camber is obtained from the sleeve/insert.

The calculations assume the current sleeve/insert is a ZERO (no offset). If it is not, examine the slot orientation to determine if the previous installation corrected camber or caster. Enter the value of the old sleeve/insert in the box below either caster or camber, whichever most accurately reflects the orientation of the slot.

**Note:** Whenever there is a sleeve/insert installed that is not zero, it is difficult to determine its affect on the calculation of the new required sleeve/insert. It is a good idea to have a few zero sleeves available to install in the truck and remeasure caster to get a true initial reading.

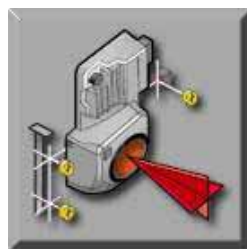

### ADR Adjustment

Immediately after the vehicle is selected, the operator is asked if the vehicle is equipped with Adaptive Cruise Control (Volkswagen Phaeton for example). The sequence is only for vehicles with this feature. After normal alignment inspections and customer date entry, the first Phaeton specific screen is the information screen that gives an overview of the process. Follow on-screen instructions



## Maintenance

### Maintenance Menu

This screen is the hub of all service and maintenance. Icon selections are:



**1. Calibration** – the software that enables the measuring sensors to be calibrated using the optional Customer Calibration Kit. An optional ISO calibration fixture is also available for certifying systems to ISO traceable standards.

**2. Measurement Data** – primarily for service personnel, this allows access to measuring sensor direct output.

**3. Preventative Maintenance** – a software feature that guides the equipment operator through recommended periodic aligner maintenance.

**4. Demo Mode** - A program used primarily by sales representatives and training personnel. This is program that demonstrates the capabilities of the aligner software without actually having measuring sensors or a vehicle available. It is a useful tool for training new or experienced users about machine features.

**5. Windows Utilities** – Allows access to the Windows Desktop and also allows the operator to perform routine installation of printers, software, etc.

**6. Database Utilities** – The feature is used for backing up and restoring alignment based data files, customer data, etc.

**7. Speaker Training** – Optional Hardware / Software package that allows an end-user to control the aligner through voice commands.

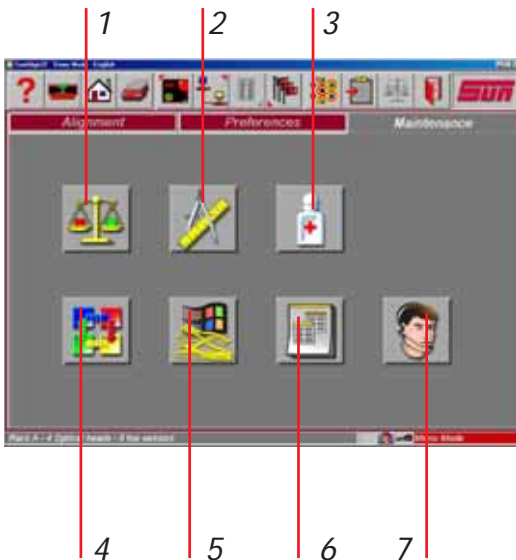



	LF	RF	LR	RR
Cross Toe	0.00	0.00	0.00	0.00
Track Toe	0.00	0.00	0.00	0.00
Camber	0.00	0.00	0.00	0.00
Rack A	0.00	0.00	0.00	0.00
Rack B	0.00	0.00	0.00	0.00
Floor	0.00	0.00	0.00	0.00
SAI	0.00	0.00	0.00	0.00



## Calibration Menu

### Camber/SAI/Cross Toe Calibration

Calibration of the measuring sensors requires the Customer Calibration Kit. This kit consists of a steel-tube bar approximately 5 feet long and a pair of stands, (with screw/knob assemblies). Make sure these items are present before proceeding with the calibration. There are three separate subsystems that must be calibrated – cross toe, track toe, and camber/SAI sensors. Cross toe measures wheel angles across the front or back of the vehicle. Camber and SAI sensors measure wheel tilt angles. Cross toe and Camber/SAI and Track toe calibration is performed by placing the sensors on the calibration bar and stands. Each sensor has a toe system that measures angles from the front to rear.

### Calibration Factors

The calibration factors can be viewed at anytime by selecting the Calibration Factors icon from the Calibration Menu. These factors are referenced each time an alignment is performed. Notice there are three sets of camber factors for the three alignment surfaces.

### Calibration History

The past 10 calibrations of the Aligner can be viewed by selecting the Calibration History icon on the Calibration Screen. It gives a graphical presentation of the calibration factors of any sensor selected, allowing a visual tracking of any problem areas. Selecting any of the buttons below the sensor selection brings up the calibration information for all 4 sensors, along with dates the calibrations were performed.

The calibration history displays the last 10 calibrations performed on the aligner. The chart is graphed, the X factor is numbered 1 thru 10 (last 10 calibrations) 1 being the calibration just performed and the Y factor is numbered -2.0 thru +2.0 (Raw Data).

By selecting the radio button under the “Sensor” the unit will return a graph for that Wheel Sensor and display the last 10 calibrations for each component inside the wheel sensor. The operator also may view any notes that may have been entered by selecting the buttons in the lower half of the screen. Each time a calibration is performed the 10th calibration history and notes are purged and the history is moved 1 becomes 2 and 2 becomes 3 and so on up through 10.



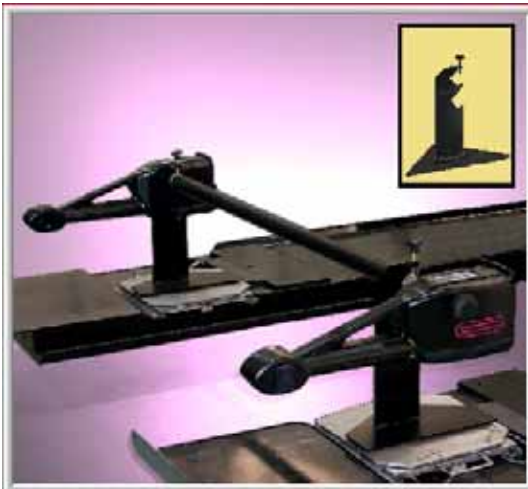

## Front Sensor Calibration procedures

Note: Follow all on-screen instructions carefully to ensure quality results.

1. Click on the Camber/SAI Calibration icon on the Calibration screen.
2. Select whether the front or rear sensors are to be calibrated by clicking on the proper radio button.
3. Choose the rack that the calibration is to be performed on. Up to 3 alignment surfaces can be utilized, and each must be calibrated independently. In most shops, Rack A is the primary alignment surface – choices are Rack A, Rack B, or Floor. Each alignment surface can be renamed to whatever is desired. See renaming instructions in the “Setup” chapter.
4. Set the calibration stands on the front (turn plates) with the open end of the stands facing the rear of the alignment lift. Set the calibration bar into the notched sections of the stands with the numbers that are printed on the bar on the left hand side. Click on the “OK” button in the lower right hand corner.

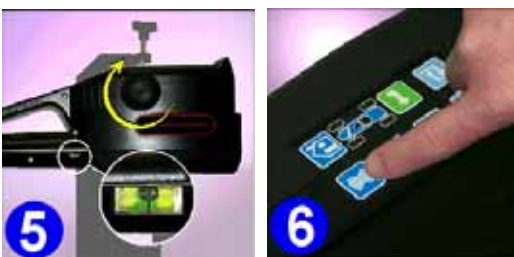

Next step

1. Rotate the bar forward until the #4 is at 12:00.
2. Slide both the left and right front sensors into the calibration bar with the groove on the stub shaft facing up.
3. Hand tighten the left and right thumb screws on the calibration bar.
4. Rotate the bar forward until the #1 is at the 12:00 position.
5. Level and lock both sensors using the level vial that is mounted on the outside shell of the sensor. This procedure automatically sets the electronic level inside the sensor.
6. Gently press the “runout” button on one of the front sensors.





Next step

1. Un-lock both the left and right sensors by turning the knob counter clockwise.
2. Rotate the bar forward until the #2 is at 12:00.
3. Using the electronic level on the keypad, level both the left and right sensors and lock them using the sensor locking knob.

Note: if a sensor is not level during this step a message is displayed on screen indicating to level the sensors.



4. Gently press the runout button.



Next step

1. Un-lock both the left and right sensors by turning the knob (counter clockwise).
2. Rotate the bar forward until the #3 is at 12:00.
3. Using the electronic level on the keypad, level both the left and right sensors and lock them using the sensor locking knob.

4. Gently press the runout button.



Next step

1. Un-lock both the left and right sensors by turning the knob counter clockwise. Rotate the bar backwards to position number "4".
2. Lock the calibration bar by tightening the hand screw on the calibration stands.
3. Using the electronic level on the keypad, level both the left and right sensors and lock them using the sensor locking knob.

4. Gently press the runout button.





Next step

1. Swap the entire assembly from left to right so that the left sensor is on the RH side facing rearward and the right sensor is on the LH side facing rearward. The calibration bar must also be rotated so that the numbers are on the RH side of the alignment lift.



2. Rotate the calibration bar so that the number "4" is in the 12:00 position.
3. Using the electronic level on the keypad, level both the left and right sensors and lock them using the sensor locking knob.
4. Gently press the runout button.



Next step

1. Remove the wheel sensors from the bar and orient them so that both rear toe sensors are facing each other.
2. Using the electronic level on the keypad, level both the left and right sensors and lock them using the sensor locking knob.



3. Gently press the runout button.



	Current	New	Change	Comments
Left Crown Top	0.00	0.00	0.00	
Right Crown Top	0.00	-0.04	-0.04	
Left SA	0.00	0.00	0.00	
Right SA	0.00	0.00	0.00	
Work 4	0.00	0.00	0.00	
Left Carrier	0.00	-0.04	-0.04	
Right Carrier	0.00	-0.04	-0.04	
Left Front Track Top	0.00	0.00	0.00	
Right Front Track Top	0.00	-0.04	-0.04	

### Next step

After calibration a screen will appear displaying the calibration factors of all systems within the front sensors. The screen has three columns of numbers. The first column “New” displays the calibration factors that were just obtained. The second column “Current” displays the calibration factors that were obtained from the previously performed calibration. The last column “Change” shows the total amount of change between the two calibrations. Should a factor exceed the usable limit, a warning will be displayed which indicates a possible problem and will recommend that a service technician be called. Clicking on the “Cancel” button will reject the new calibration factors and return to the Calibration Screen. Clicking on the “OK” button will accept the new factors and use them to perform alignments. A fourth column called “Comments” allows the operator to enter any notes about why the calibration was performed.

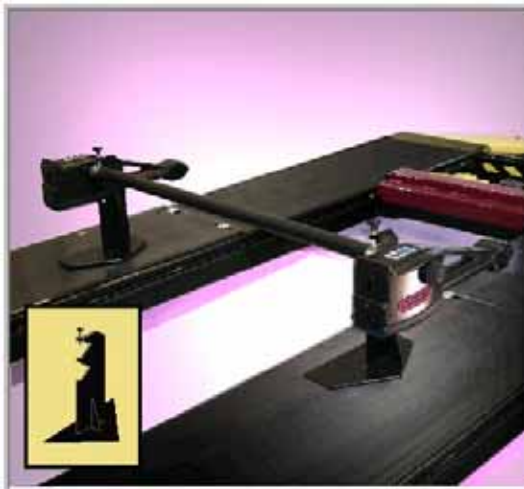

### Rear Sensor Calibration

Repeat the calibration process for the rear sensors by choosing “Rear Sensors” from the calibration menu. The rear wheel sensors must be mounted at the rear of the alignment rack for this process.

## Preventative Maintenance

The aligner software has a Preventative Maintenance feature that insures the aligner is kept at peak operating performance. When the Preventative Maintenance icon is selected from the Maintenance Tab, a screen appears with three tabs:

**Weekly** – items that should be addressed on a weekly basis

**Monthly** – items that should be addressed on a monthly basis

**History** – shows the dates maintenance was performed, provides selection of maintenance day



## Maintenance Checklist

The items listed represent the weekly chores to be performed and checks that should be made. A similar list is available for Monthly Maintenance. The choices are Checked, Service, or Replace, depending on the operator's input. A text block is available to enter information about the item maintained.



## Maintenance History

A listing of the dates, who the person was who performed the maintenance, and whether it was weekly or monthly maintenance is shown. Details of the maintenance procedure can be shown by highlighting any date, then select OK.

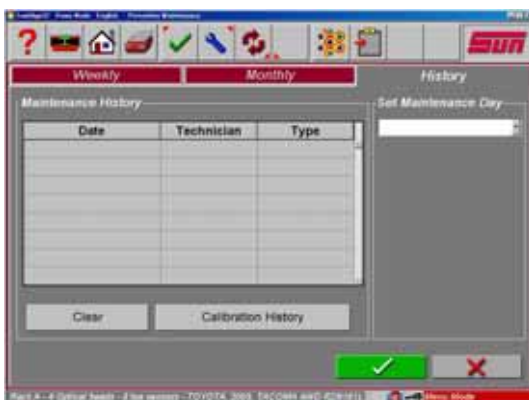

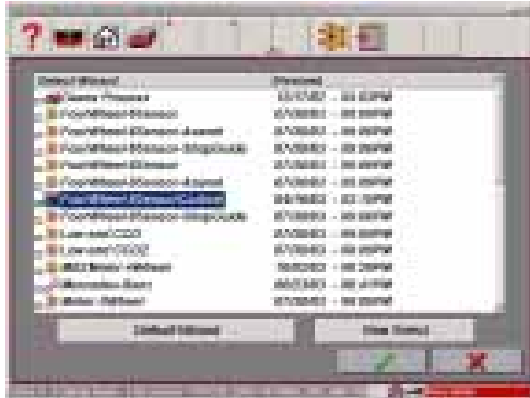

## Wizards - Editing and Creating

### Modifying Existing OEM Wizards

To access an existing wizard press “**Ctrl-Alt-E**” from any screen. The wizard select menu will appear, select the wizard you wish to use as a base line such as “Standard-Alignment”.

Double Click on the highlighted wizard to view the steps included in this wizard. This wizard illustrates how the procedures within a normal alignment are ordered when using this wizard.

Determine how you wish to modify this wizard.

If you wish to customize or modify this procedure select “*Add Step Before*” or “*Add Step After*” or “*Delete Step*”.

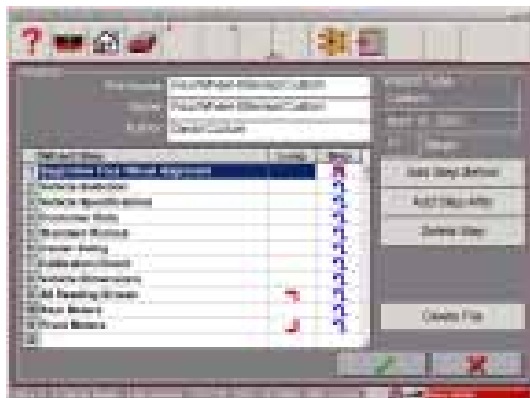

### Adding a Procedure

Locate the desired procedure to be added located in the popup menu, click once to highlight. Click OK to add this step to the open wizard.

### Deleting a Procedure

An undesired procedure can be deleted from any wizard. Highlight the procedure to be deleted and click on “Delete Step”. Once any OEM wizard is modified it must be renamed as a custom wizard. Wizards which are already custom files are simply saved when OK is selected.

Once the wizard has been modified you must save it as a different file name. Change the Authors name as well if desired. OEM wizards cannot be modified but must be renamed as custom wizards. The OEM procedure will be copied to the new procedure. Click OK to save.





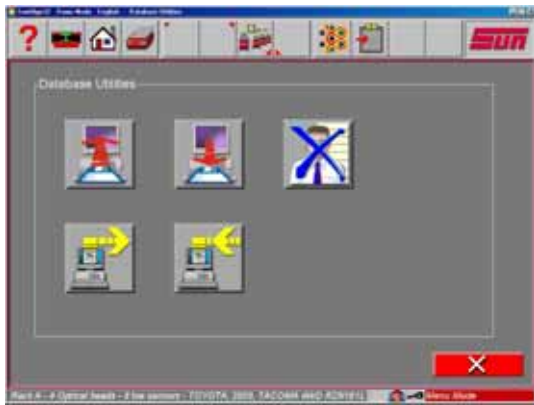

## Database Utilities

Customer Data Files created and stored on the computer should be backed up frequently. In the event of a computer disk malfunction, records of past alignment procedures can be restored.

The Database Utility menu provides for the backup as well as the restoration process. Floppy disks will be required for archiving data. The size or quantity of files determine how many files can be archived on each floppy. Normally several hundred files can be stored on each disk. Secure backup disks in a location different from that of the aligner. Mark each disk clearly of its content as well as the date of backup.



**Note:** When data files are restored to the aligner, all files currently on the system will be overwritten. Therefore it is very important that restoration take place only in the event of database failure.

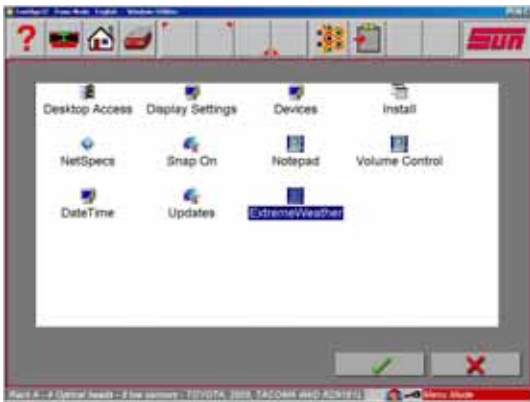

## Windows® Utilities

Machines can be configured to operate in the Windows® desktop mode, where the conventional desktop and its applications are viewable by the user. Or, the system can be set up to operate in the “Non-Desktop” mode so the normal Windows® applications are hidden from the user. Certain application must be accessible when in the non-desktop mode for normal machine maintenance. Adding printers, on-line specifications updates, adding devices, features and modifying the display are some activities required during normal use.

Computer connections (actual computer may look different)

Voice control hardware assembly



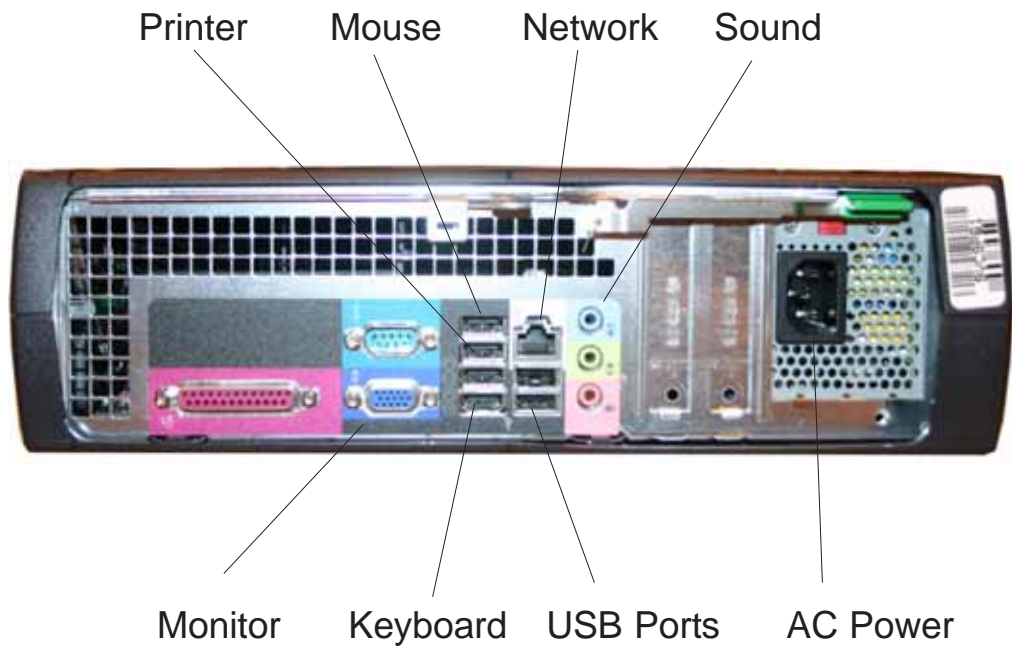

Computer connections - NOTE: Printer, Mouse and Keyboard are all USB devices, plug into any port



Voice control hardware assembly

## NOTES



**NORTH AMERICA**

309 Exchange Avenue

Conway, Arkansas 72032

Tel.: (800) 362-8326 or (501) 450-1500

Fax: (501) 450-1585

**Notice:** The information contained in this document is subject to change without notice. **SUN EQUIPMENT** makes no warranty with regard to this material. **SUN EQUIPMENT** shall not be liable for errors contained herein or for incidental consequential damages in connection with furnishings, performance, or use of this material.

This document contains proprietary information which is protected by copyright and patents. All rights are reserved. No part of this document may be photocopied, reproduced, or translated without prior written consent of **SUN EQUIPMENT**.



is a registered trademark of SUN EQUIPMENT and Snap-on Incorporated