

Quick Guide V2260, V2280, V2380



Illustration shown above EEWA544TH3 with optional EAA0483J81A Tower Motor

EEWAEU543TH*, EEWA*544TH*, EEWA545T*3

All information contained or disclosed in this document is considered confidential and proprietary by Snap-on. All manufacturing, use, reproduction, and sales rights are reserved by Snap-on and the information contained herein shall not be used in whole or in part without the express written consent of Snap-on.

Table of Contents

SAFETY INFORMATION.....	1
SAFETY INSTRUCTIONS.....	2
MAINTENANCE	4
SYSTEM STARTUP	5
SHUT DOWN PROCEDURES.....	6
SYSTEM MAIN MENU	7
BEGIN AN ALIGNMENT.....	8
START ALIGNMENT	8
VEHICLE SUMMARY.....	9
VEHICLE POSITIONING SCREEN.....	9
LEVEL AND LOCK THE STEERING WHEEL.....	10
CASTER.....	11
EZ-TOE	13
ELEVATED ADJUST.....	13
WHEELS OFF ADJUSTMENT	13
GUIDED ALIGNMENT ADJUSTMENTS	13
VEHICLE DIMENSIONS	13
RIDE HEIGHT MEASUREMENT.....	13
FINAL.....	13
REPORTS	13
OPTIONAL TOWER MOTORIZED KIT	14
OPTIONAL MANUAL TOWER MOVEMENT.....	15

SAFETY INFORMATION

For your safety, read this manual thoroughly before operating the equipment.

The Aligner is intended for use by properly trained skilled automotive technicians. The safety messages presented in this section and throughout the manual are reminders to the operator to exercise extreme care when performing wheel alignments with this product.

There are many variations in procedures, techniques, tools, and parts for servicing vehicles, as well as the skill of the individual doing the work. Because of the vast number of vehicle applications and potential uses of the product, the manufacturer cannot possibly anticipate or provide advice or safety messages to cover every situation. It is the automotive technician's responsibility to be knowledgeable of the vehicle to be aligned. It is essential to use proper service methods and perform wheel alignments in an appropriate and acceptable manner that does not endanger your safety, the safety of others in the work area or the equipment or vehicle being serviced.

It is assumed that, prior to using the Aligner, the operator has a thorough understanding of the vehicle systems being serviced. In addition, it is assumed he has a thorough knowledge of the operation and safety features of the alignment rack or lift, and has the proper hand and power tools necessary to perform wheel alignments.

When using your garage equipment, basic safety precautions should always be followed, including:

1. Read all instructions.
2. Care must be taken as burns can occur from touching hot parts.
3. The socket-outlet (wall outlet) shall be located near the equipment and shall be easily accessible.
4. Do not operate power tools or equipment with a damaged power cord or if the equipment has been dropped or damaged until it has been examined by a qualified serviceman.
5. Do not let cord hang over edge of table, bench or counter or come in contact with hot manifolds or moving fan blades.
6. If an extension cord is necessary, a cord with a current rating equal to or more than that of the equipment should be used. Cords rated for less than the equipment may overheat. Care should be taken to arrange the cord so that it will not be tripped over or pulled.
7. Always unplug equipment from electrical outlet when not in use. Never use the cord to pull the plug from the outlet. Grasp plug and pull to disconnect.
8. Let equipment cool completely before putting away. Loop cord loosely around equipment when storing.
9. To reduce the risk of fire, do not operate equipment in the vicinity of open containers of flammable liquids, such as gasoline.
10. Adequate ventilation should be provided when working on operating internal combustion engines.
11. Keep hair, loose clothing, fingers, and all parts of body away from moving parts.
12. To reduce the risk of electrical shock, do not use on wet surfaces or expose to rain.
13. Use only as described in this manual. Use only manufacturer's recommended attachments.
14. ALWAYS WEAR SAFETY GLASSES. Everyday eyeglasses only have impact resistant lenses, they are NOT safety glasses.
15. Know and understand the proper operating procedures for all power tools used.
16. *Caution:* Risk of explosion if any battery is replaced by an incorrect type. Dispose of used batteries according to local and state government regulations.

**IMPORTANT!! SAVE THESE INSTRUCTIONS
DO NOT DISCARD!!**

SAFETY INSTRUCTIONS

IMPORTANT!! SAVE THESE INSTRUCTIONS



Risk of electrical shock.

- **Do not operate equipment with a damaged power cord or if the equipment has been dropped or damaged, until it has been examined by a qualified service person.**
- **If an extension cord is necessary, a cord with a current rating equal to or greater than that of the equipment should be used. Cords rated for less current than the equipment can overheat.**
- **Unplug equipment from electrical outlet when not in use. Never use the cord to pull the plug from the outlet. Grasp plug and pull to disconnect.**
- **Do not expose the equipment to rain. Do not use on wet surfaces.**
- **Plug unit into correct power supply.**
- **Do not remove or bypass grounding pin.**

Contact with high voltages can cause death or serious injury.



Risk of electrical shock. High voltages are present within the console unit.

- **There are no user serviceable items within the console other than the keyboard and printer.**
- **Service on the unit must be performed by qualified personnel.**
- **Do not open any part of the console other than noted areas.**
- **Turn power switch off and unplug the unit before servicing.**

Contact with high voltages can cause death or serious injury.



Risk of eye injury. Debris, dirt, and fluids may drop from vehicles.

- **Knock off any loose debris. Clean surfaces as needed to avoid any materials from falling.**
- **Wear approved safety glasses when servicing.**

Debris, dirt, and fluids can cause serious eye injury.



Risk of crushing. Vehicles may roll off alignment lift if not secured.

- **Leave automatic transmission in park or manual transmission in gear unless equipment operation steps require vehicle in neutral.**
- **Apply parking brake unless equipment operation steps require wheel movement.**
- **Use wheel chocks whenever vehicle is positioned on the lift.**
- **Follow rack or lift manufacturer's safety recommendations when lifting a vehicle.**

Vehicles rolling off lifts can cause death or serious injury.



Risk of entanglement or crushing. There are moving parts on vehicle lifts during operation.

- **Keep all persons clear of lifts.**
- **Read lift manufacturer's operation instructions carefully.**
- **Follow lift manufacturer's safety recommendations.**

Contact with moving parts could cause injury.



Risk of pinching or crushing body parts when jacking vehicles.

- **Keep hands and other body parts away from jacking surfaces.**
- **Do not use unapproved adapters (i.e. wooden blocks) when jacking a vehicle.**
- **Do not bypass any jack manufacturer's safety features.**
- **Read jack manufacturer's operation instructions carefully.**
- **Follow jack manufacturer's safety recommendations.**

Improperly used or maintained jacks can cause injury.



Risk of burns.

- **Do not touch hot exhaust systems, manifolds, engines, radiators, etc.**
- **Wear gloves whenever performing a service near hot components.**

Hot components can cause burns.



Risk Of Explosion.

- **This equipment has arcing or sparking parts which should not be exposed to flammable vapors.**
- **This equipment should be located at least 460mm/18inches above the floor, and not in a recessed area.**
- **Do not operate with the cover of the electrical box removed.**
- **Do not remove/alter grounding wires.**



Risk of pinching when camera beams and/or pods are in motion

- **Keep hands and other body parts away from camera beams and/or pods when they are in motion**



Risk of injury. Tools may break or slip if improperly used or maintained.

- **Use the correct tool for the task.**
- **Frequently inspect, clean, and lubricate (if recommended) all tools.**
- **Follow recommended procedures when performing vehicle services.**

Tools that break or slip can cause injury.

MAINTENANCE

Service of an aliger requires extreme care and knowledge. Service should be performed only by a qualified service technician.

- Always check equipment for damaged parts before use.
- Replace or repair damaged parts before use. Check alignment of moving parts. Binding of moving parts or broken parts may alter operation.
- Have damaged parts properly repaired or replaced by an Authorized Service Center.
- Do not use equipment if switch does not turn it on and off.
- Maintain equipment. Keep equipment dry, clean and free of oil and grease for better and safer performance.
- Clean the glass surfaces of all targets once a week with an ammonia-free cleaner and a lint-free cloth.
- Lightly lubricate the lead screw on the wheel clamps once a month with machine oil.
- Lightly lubricate the rubber o-rings on the wheel clamp claws once a month with machine oil.
- For the location of the nearest Snap-on repair center, call Snap-on customer service.

WARNING

- Use safety equipment, Always wear eye protection.
- Wear safety gloves as necessary to protect hands.
- Not for outdoor use exposed to rain or heavy condensation

INFORMATION:

Should the system become unresponsive in the event of a severe power fluctuation such as Electrical Fast Transients or Electrostatic Discharge. To restore the unit to operating condition, turn off all power switches, wait 10 seconds, and then turn back on.

SYSTEM STARTUP

Once the aligner is in the alignment location plug power cord into the wall outlet. NOTE: There are two power cords. One for the cabinet and one for the camera beam / tower.

System Power Requirements:

115v AC, 15 amp Circuit, or 230v AC 10 amp Circuit - 1Ph. (must have Earth ground)

Locate the power switch located on the backside of the cabinet and on the electrical box on the tower. Switch to the On position and allow a few moments for system startup.



When the power switch is turned on, the unit initiates the system boot-up. This boot sequence will take a few moments.

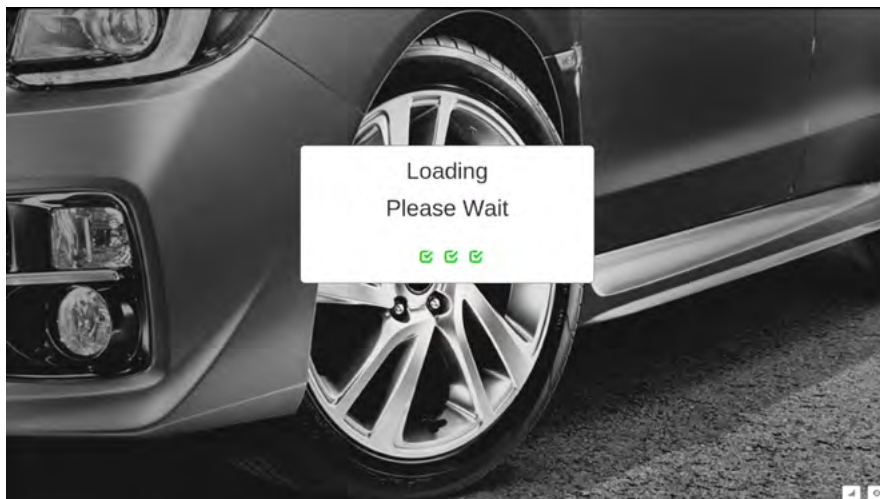

The Home screen will appear next as the software finishes loading.

SHUT DOWN PROCEDURES

It is recommended that the system be shut down using this procedure. Although powering down the system by directly shutting off the power switch has been used, the “Shut Down” procedure ensures the Host Controller is properly powered down. After shutting down the software, the switch(s) must both be toggled off to remove electrical power from the Host Controller (cabinet) and Camera Beam. (see photo)

1. From the Main Menu click on “Shut Down”.

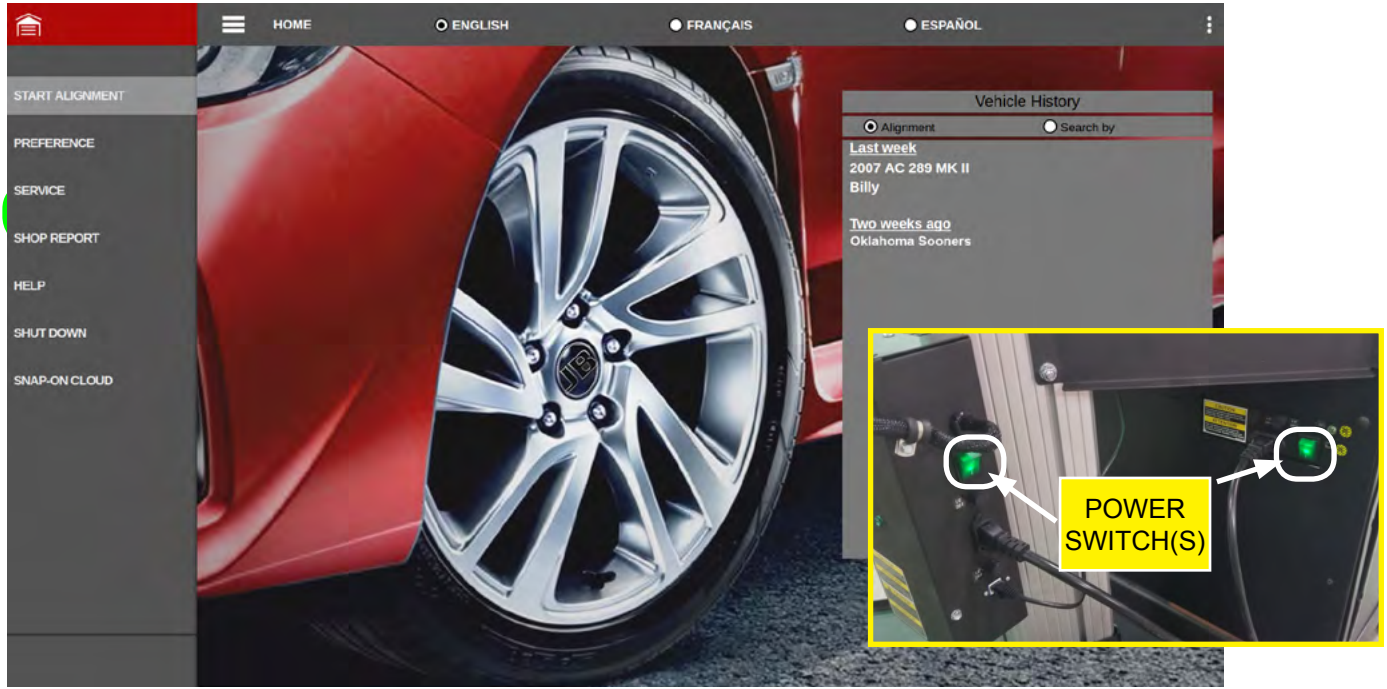

2. The user is given approximately 10 seconds to abort the unit Shut Down process by clicking on the <BACK> button.

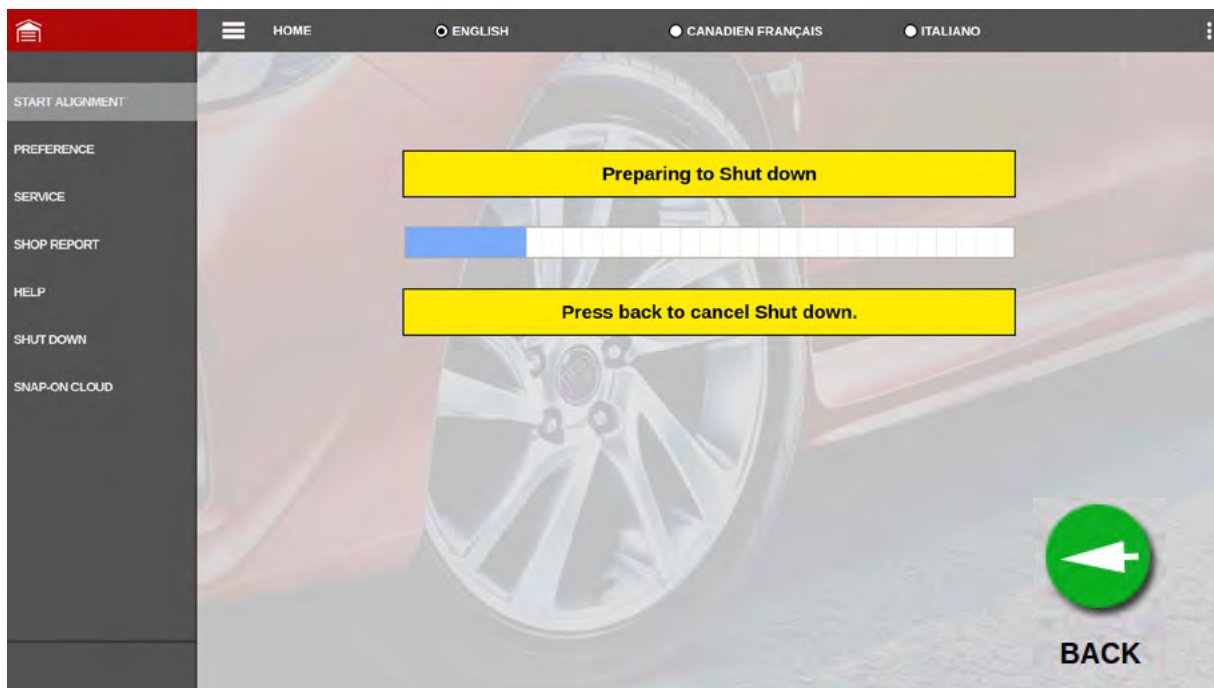

SYSTEM MAIN MENU

All system usage resides from the Home Screen. Each function of the aligner will be followed with screen prompts. The user needs to simply click a command and the aligner will easily prompt the user to the next step. No guessing required as the system has been designed with each user in mind.

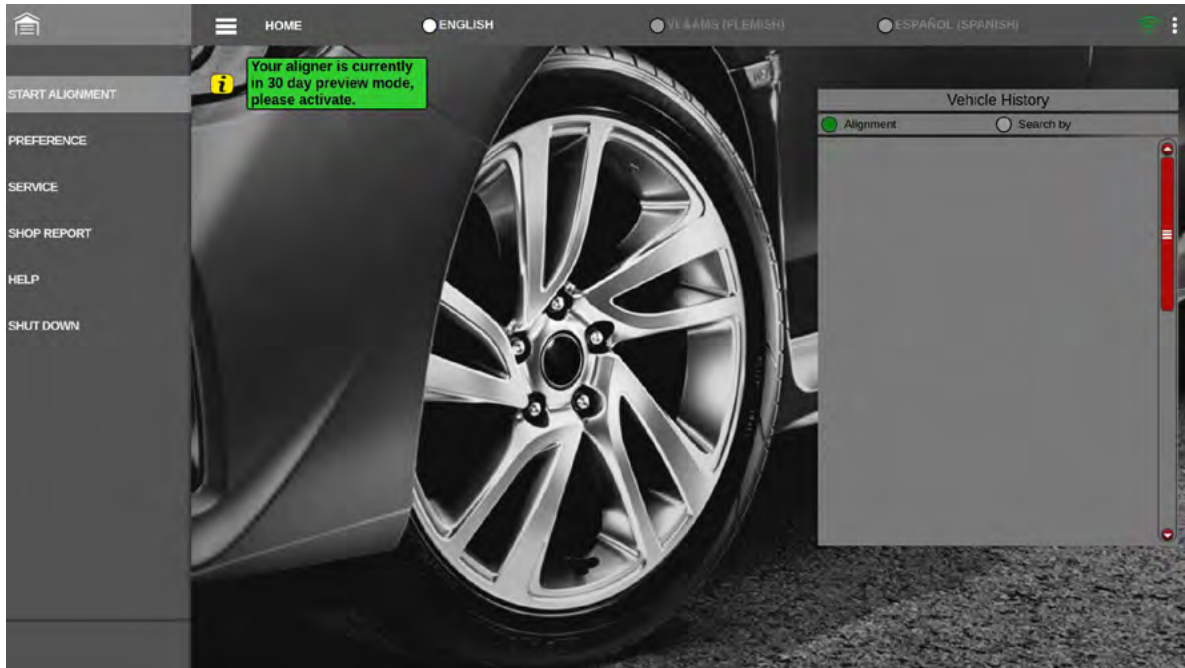

- **Start Alignment** - Begin an alignment process
- **Preferences** - A menu to setup the aligner for desired user interaction
- **Service** - Choose to access the local or network server, access the Calibration sub menu and several diagnostic screens.
- **Shop Report** - Used to lookup previous alignments and used to select the data based on selective dates.
- **Help** - Select to display assistance for the selected screen.

NOTE: THE "MENU" PULL OUT TAB IS AVAILABLE ON MOST PAGES TO ALLOW YOU ACCESS OF IMPORTANT SCREENS REGARDLESS WHERE YOU ARE IN THE ALIGNMENT PROCESS.



BEGIN AN ALIGNMENT

START ALIGNMENT

Before beginning the alignment the vehicle being serviced should be selected from the database so the machine can reference the manufacturers specifications. If a VIN Reader is present simply scan the VIN code of the vehicle and choose the vehicle from the sub-menu. If a VIN Reader is not available follow the steps listed below for choosing a vehicle.

First select Make of the vehicle

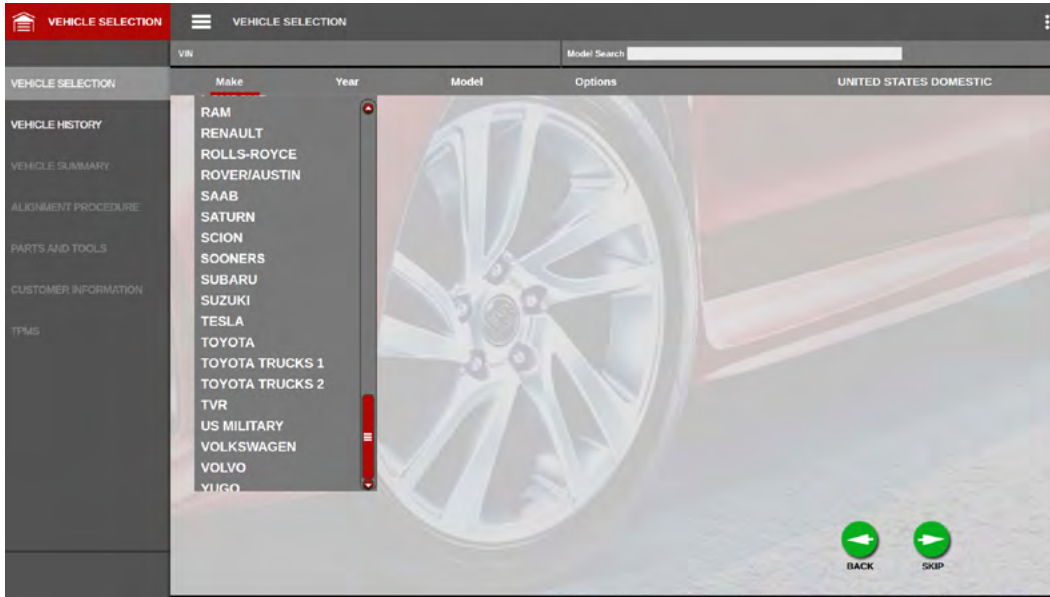

Next select the Year of vehicle

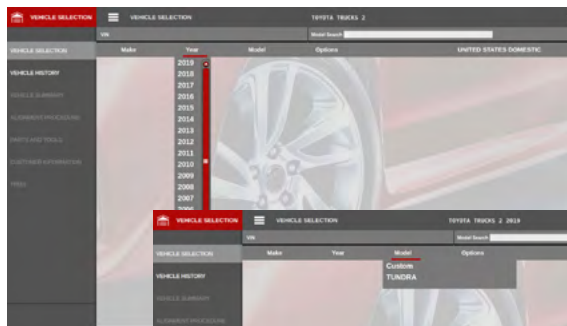

Select the Model

Then select Options if applicable. Vehicle Options are usually listed on a "Service Parts ID Label". This label is found on some vehicles on the spare tire cover, rear compartment, glove box or door post.

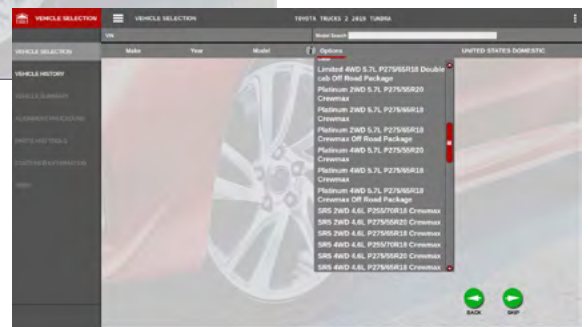

Click on “Use Vehicle” to continue with the alignment.

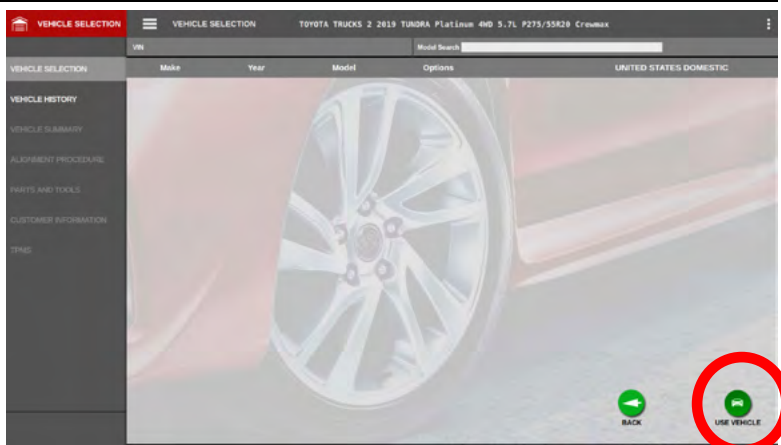

VEHICLE SUMMARY

The Vehicle Summary page displays the alignment specifications, any safety recalls and other special considerations required of the vehicle being aligned. Some considerations are: Vehicle loading, ride height requirements and if an SAS reset is required after adjustment. Click on “Start” to continue.

- Premium – Mitchell content for units connected to the network with a valid subscription
- Standard – Local images and videos for units not connected to the network or who do not have a valid subscription
- Premium content will automatically be disabled if the aligner is not online while selecting the vehicle

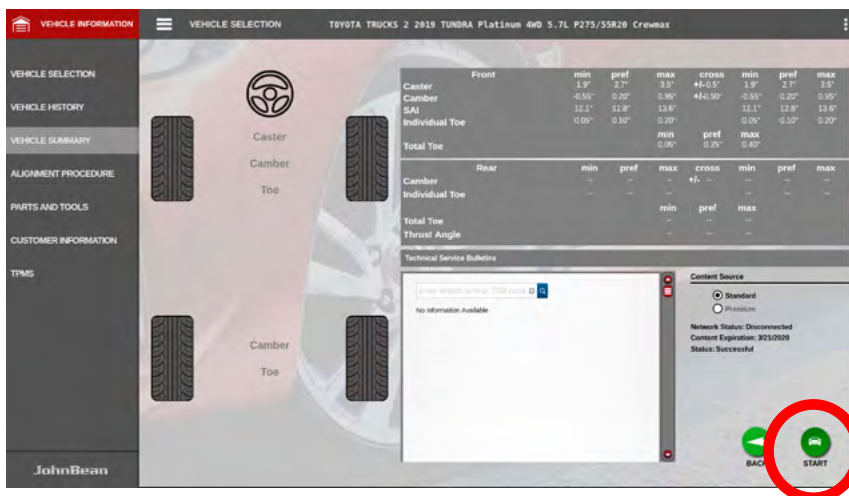

VEHICLE POSITIONING SCREEN

The aligner is equipped with split roll. The vehicle compensation screen displays an arrow that prompts the user to move the vehicle forward. The graphic image on the screen follows the vehicle’s movement as you roll the vehicle in the direction indicated. When the arrow turns red, stop.

Move the vehicle forward as indicated. The arrow will again turn red when the correct position is reached.

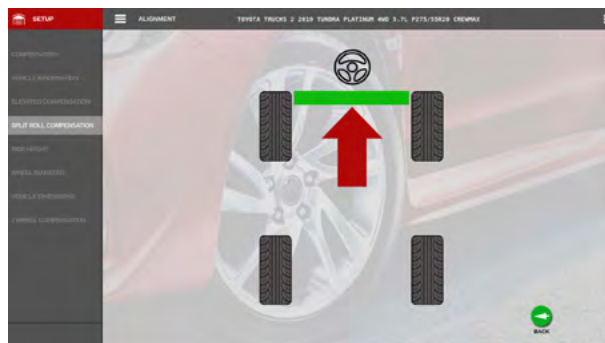
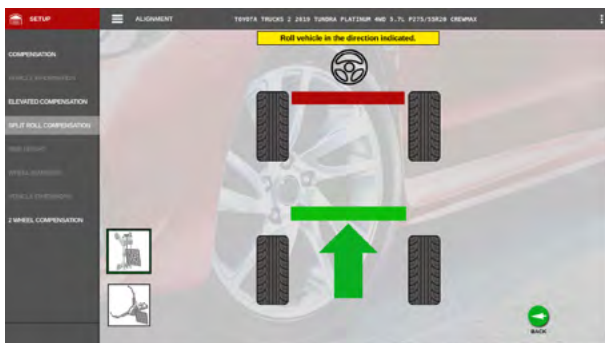

Alignment

Move the vehicle rearward to the indicated position.

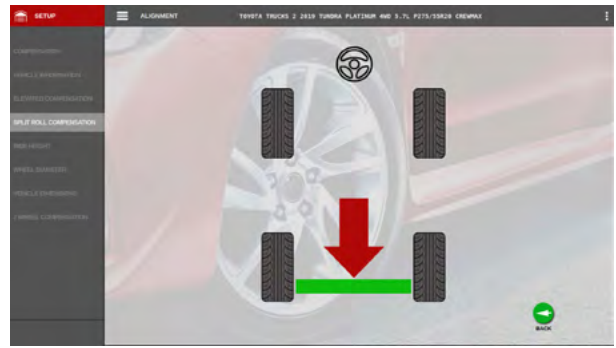
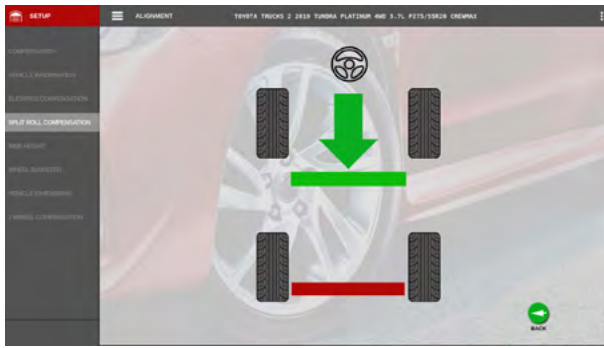

Once the vehicle has returned to the start position, compensation is complete. If changes were detected in one or more suspension angles the screen will alert the user to roll the vehicle to relieve stress and then to perform compensation again. Click Next to continue.

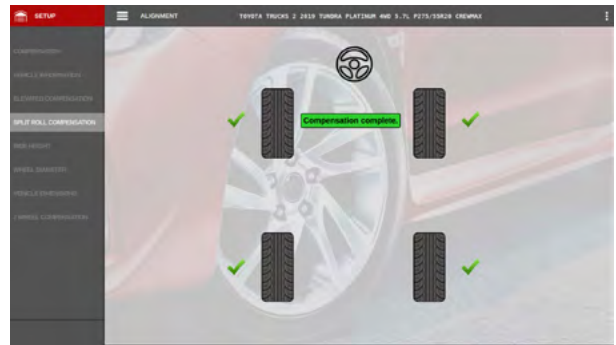
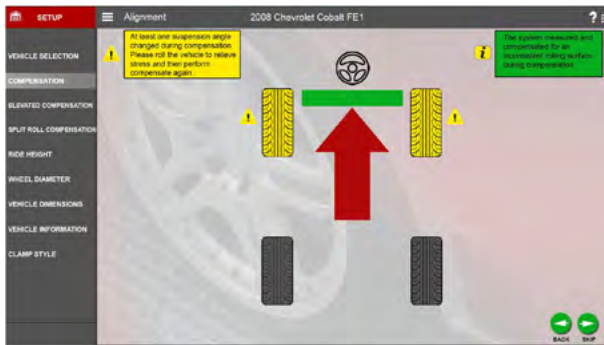

Green check marks will indicate a good positioning has been achieved.

LEVEL AND LOCK THE STEERING WHEEL

Level and lock the steering wheel. Some vehicles may require the engine be running and rock the wheel back and forth to achieve level. *Note: Be sure the turntable lock pins have been removed prior to leveling.*

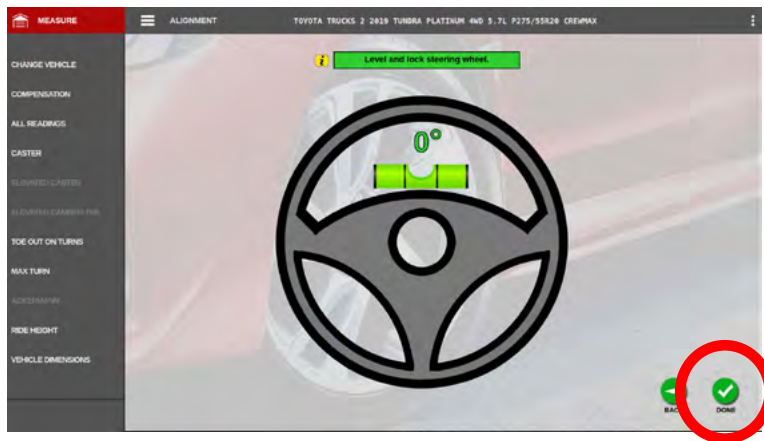

Click on "Done" to advance to Caster measurement.

CASTER

Prior to measuring caster you will be prompted to perform several necessary tasks:

1. **Start the vehicle.**
2. **Install the brake pedal depressor.**
3. **Turn off the vehicle.**
4. **Unlock the turntable and rear slip plates.**
5. **Center the steering.**

Steer the wheels to the direction indicated. When you have reached the desired angle the arrow will turn red and the bar turns green.

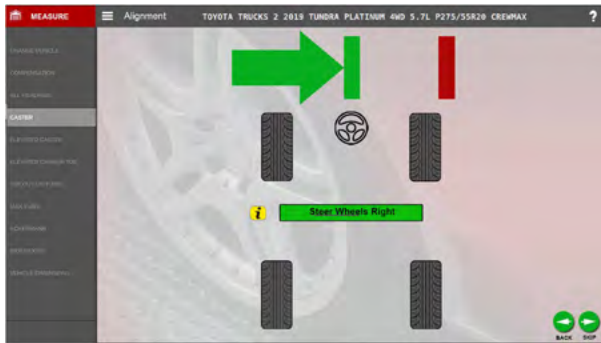

Steer the wheels in the opposite direction.

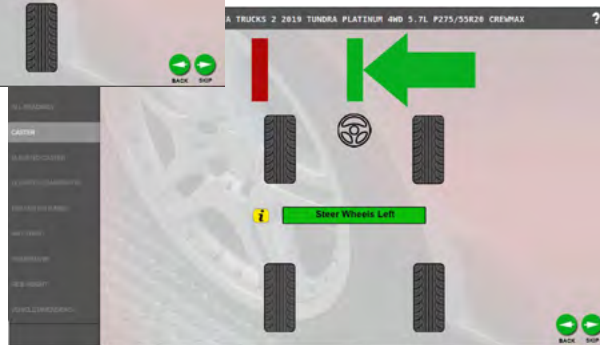

When you have reached the desired angle the arrow will turn red and the bar turns green.

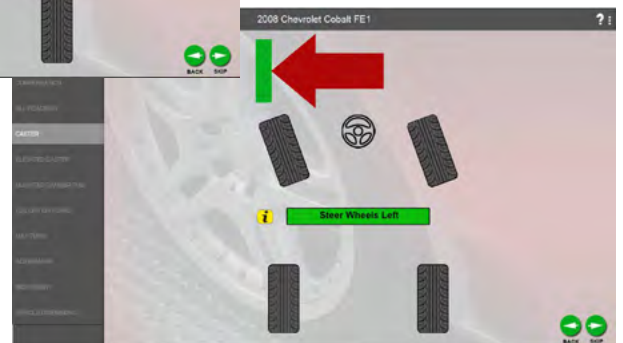

Alignment

Steer back to center. When the wheels are centered the position bar turns to green and the direction arrow will turn red to indicate correct position.

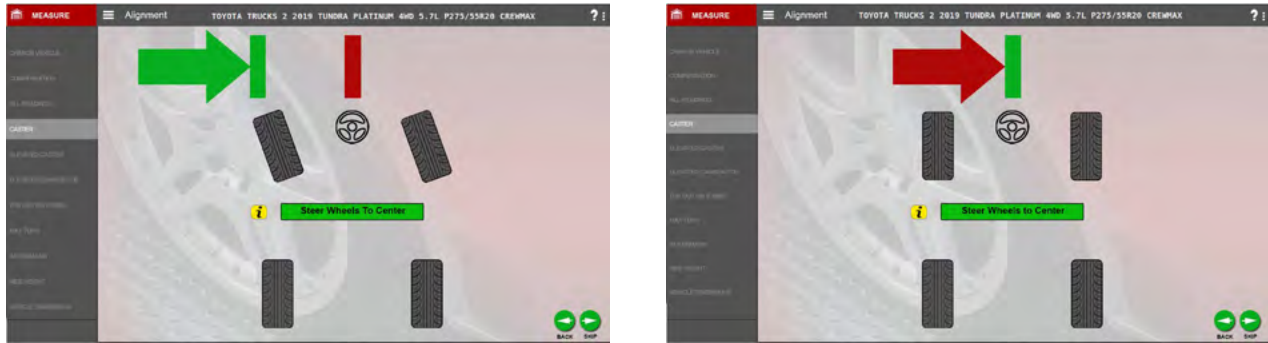

Readings

This screen illustrates all readings for both front and rear. The primary use for the Readings Screen is for the User to determine if the vehicle requires an alignment. Readings are live “Real Time” values indicating a green or red color if the value is “In” or “Out” of specification respectively.

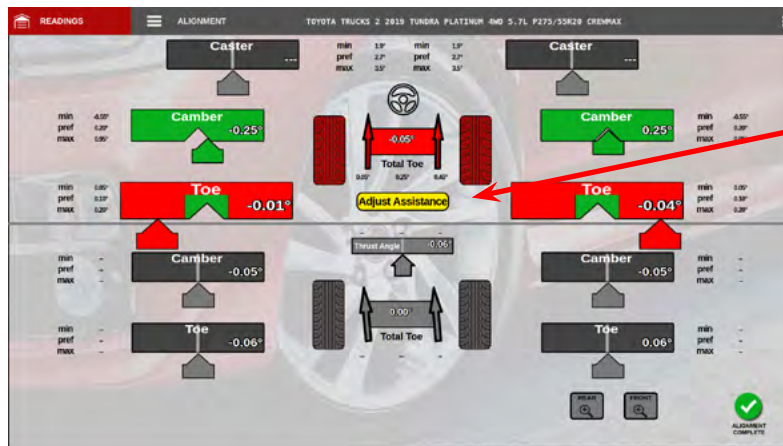

Specifications for the vehicle under test are shown on the screen with minimum, maximum and preferred values. The actual live value is shown inside the measurement block. Cross values, total toe and thrust angle are displayed in the center of the screen.

Readings that are in specification displays the pointer in green, while those out of specification are colored red.

As you adjust the vehicle for proper alignment the pointer moves indicating the direction of adjustment. The indicator pointer will turn green when it begins to “Nest” in the preferred range of specifications. A near perfect value will show to be fully nested.

NOTE: THE “MENU” PULL OUT TAB IS AVAILABLE ON MOST PAGES TO ALLOW YOU ACCESS OF IMPORTANT SCREENS REGARDLESS WHERE YOU ARE IN THE ALIGNMENT PROCESS.

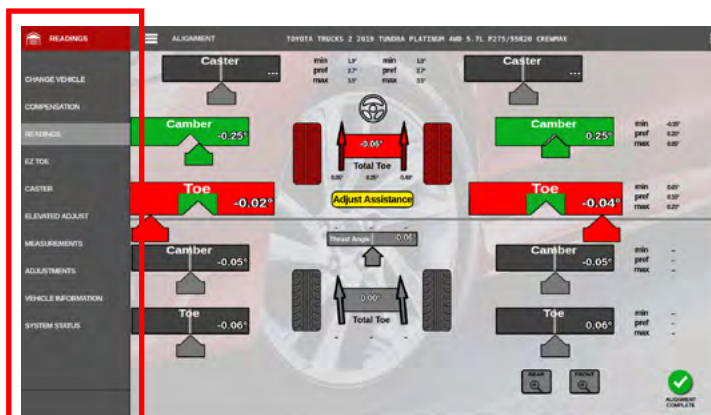

From the Menu pull out tab, click on the **“Measurements”** or **“Adjustments”** menu to access all alignment measure and adjust procedures including those below and many more.

EZ-TOE

This routine is a method of setting front toe, making it easier to obtain straight steering wheels on vehicles with difficult to reach adjustments.

ELEVATED ADJUST

Use this feature to make angular adjustments on wheels that must be unloaded

WHEELS OFF ADJUSTMENT

This feature allows the user to attach the measurement devices to wheel adapters so adjustment can be made with wheel removed.

GUIDED ALIGNMENT ADJUSTMENTS

Like cradle assistance and A-Arm adjust and others guide the technician step by step through the adjustment process

VEHICLE DIMENSIONS

Provides additional information about the condition of the vehicle’s frame, such as setback and axle offset.

RIDE HEIGHT MEASUREMENT

Use this screen to enter ride height values as measured per manufacturers instructions. These values can be compared to specification to determine suspension conformance.

Click **“Alignment Complete”** to store the values.

FINAL

This screen displays the completed angles for the vehicle tested. Click **“Done”** to continue to the Reports page.

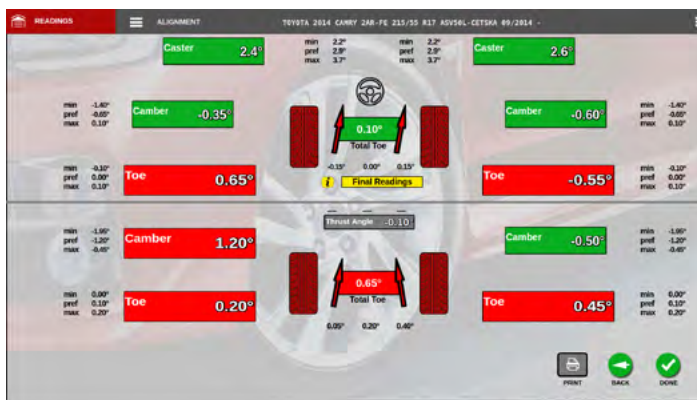

REPORTS

At the Completion of the alignment process several printable reports are available. Use the scroll bar to view the selections. The selected report is shown in the preview window in the center of the screen. The current time and the alignment duration is displayed to the right. Select **“Print”** to print the selected report or **“Home”** to save the alignment and return to the Home screen.

Select the print language to be used here.

Select **“Customer Info”** to enter information about the customer and or vehicle.

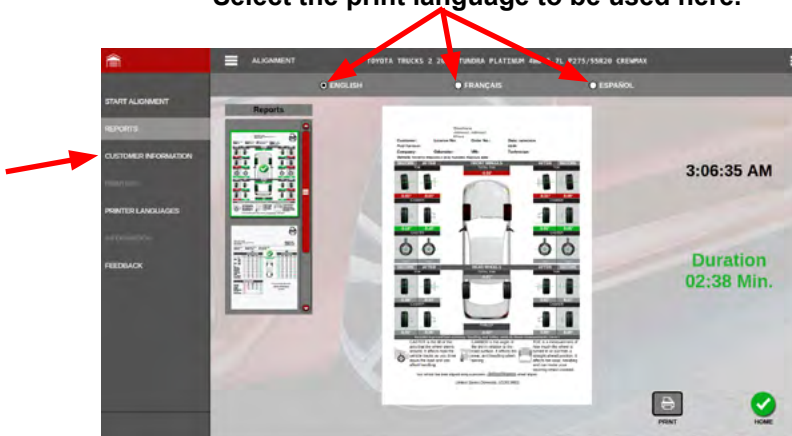

OPTIONAL TOWER MOTORIZED KIT

The optional Tower Motor kit when used allows the cameras to track the vehicle on the lift provided all 4 targets are mounted to the vehicle prior to beginning the alignment process. The cameras will either raise or lower depending on mode of operation the alignment system is processing. The user is alerted with a warning should the tracking operation become disabled. (see photo)

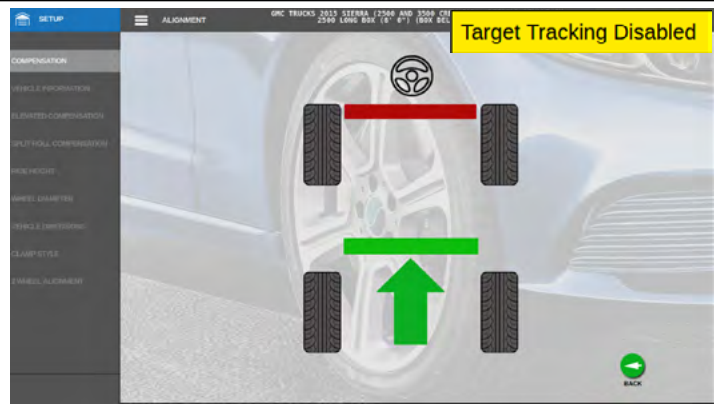

Should the camera need to be raised or lowered manually during the alignment process the user can click on the **“System Status”** option from the alignment menu.

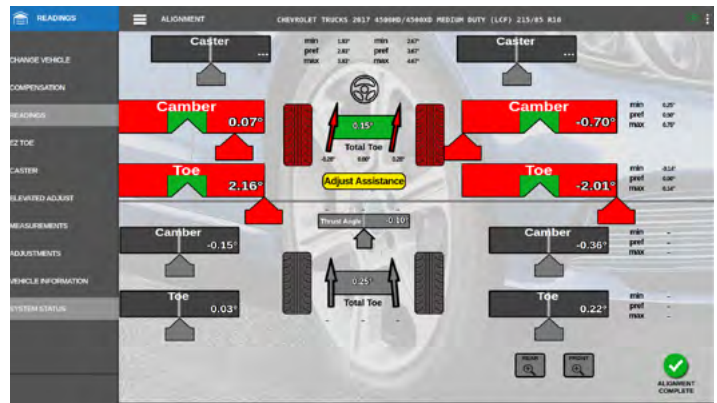

Choose the **“Camera View”** option.

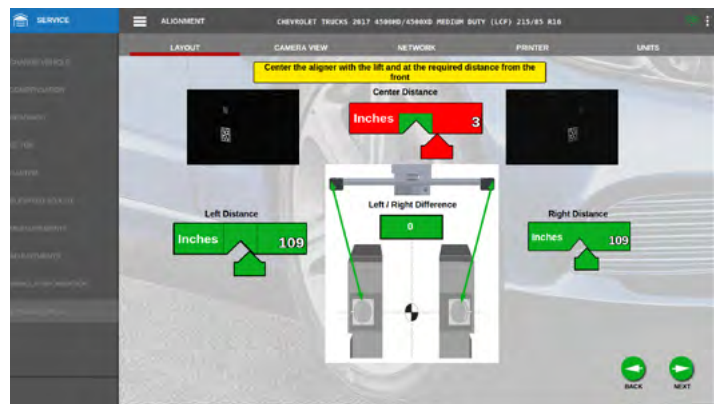

Select the **“Manual”** tracking mode and using the pointer click on either the up or down arrow depending on the direction the cameras need to be moved.

The manual option can also be selected without the use of the targets should the camera beam need to be raised or lowered. From the Main Menu select **“SERVICE”** **“CAMERA DIAGNOSTIC”**.

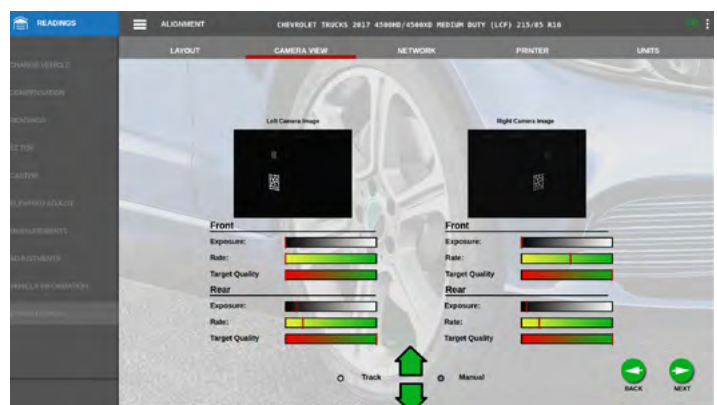

OPTIONAL MANUAL TOWER MOVEMENT

The optional Tower Manual moveable requires that the operator manually move the camera beam either up or down based on the location of the targets mounted on the vehicle. This movement of the beam is needed when the vehicle is moved up or down and the cameras loose track of the targets. This is easily identified by looking at the VODI wheel indicator lights. (see graphic below)

The camera beam can be moved by grasping the camera beam handle and moving the camera beam either up or down. Move Camera Beam until VODI lights are green.

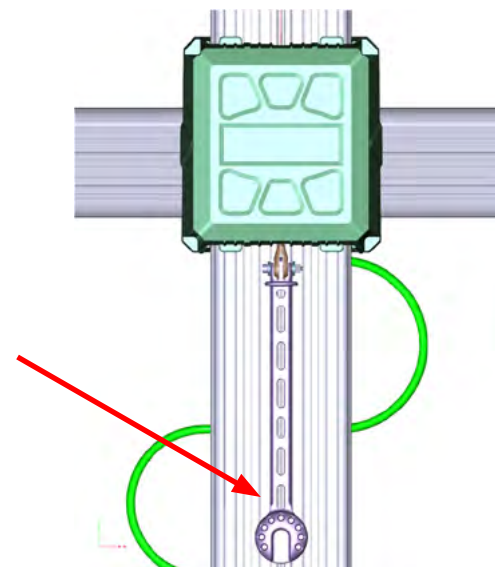

VODI lights are red and the camera beam must be moved either up or down.

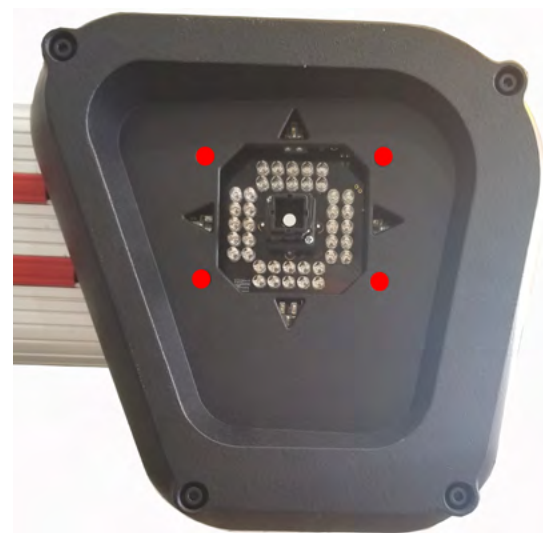

VODI lights are green the cameras can see the targets and the alignment can be completed.

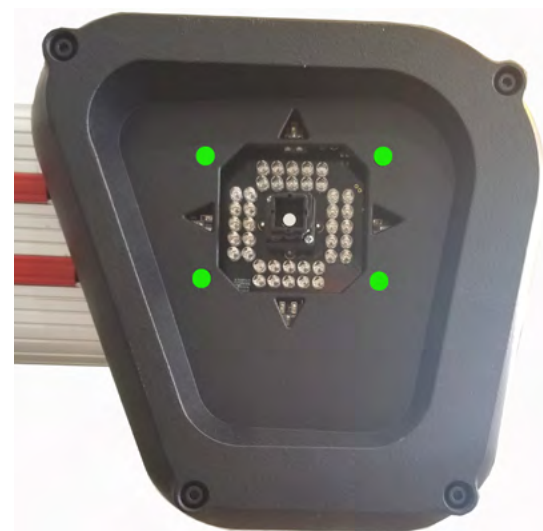

BLANK PAGE

USA

Snap-on Equipment
309 Exchange Avenue
Conway, Arkansas 72032
Tel.: (800) 225-5786

CANADA

Snap-on Equipment
6500 Millcreek Drive
Mississauga, Ontario
Canada L5N 2W6
Tel: (905) 814-0114
Fax: (905) 814-0110

Italy

Snap-on Equipment S.r.L.
Via Provinciale per Carpi 33,
42015 Correggio (R.E.), Italy
Tel. ++39 (0)522 733480
Fax: ++39 (0)522 733479

EUROPE MIDDLE EAST AFRICA JAPAN

Snap-on Equipment s.r.l. · Via Prov. Carpi, 33
42015 Correggio (RE) Italy
Phone: +39 0522 733 411 · Fax: +39 0522 733 479
www.snapon-equipment.eu

France

Snap-on Equipment France
ZA du Vert Galant · 15, rue de la Guivemone BP97175,
ST Ouen L'Aumone · 95056 Cergy Pontoise Cedex
Phone: +33 (0) 1 3448 5878 · Fax: +33 (0) 1 3448 5870
www.snapon-equipment.fr

Germany

Snap-on Equipment GmbH · Konrad-Zuse-Straße 1
84579 Unterneukirchen
Phone: +49 (0) 8634 6220 · Fax: +49 (0) 8634 5501
www.snapon-equipment.de

United Kingdom

Snap-on Equipment Ltd. · 48 Sutton Park Avenue
Reading RG6 1AZ
Phone: +44 (0) 118 929 6811 · Fax: +44 (0) 118 966 2922
www.snapon-equipment.co.uk

Notice: The information contained in this document is subject to change without notice. **Snap-on** makes no warranty with regard to this material, shall not be liable for errors contained herein or for incidental consequential damages in connection with furnishings, performance, or use of this material.

This document contains proprietary information which is protected by copyright and patents. All rights are reserved. No part of this document may be photocopied, reproduced, or translated without prior written consent of **Snap-on**.