

---

# V3300 and 770XD ALIGNER

Quick Start EEWA552B2/H2 and EEWA752B2/H2 Models



All information contained or disclosed in this document is considered confidential and proprietary by Snap-on. All manufacturing, use, reproduction, and sales rights are reserved by Snap-on and the information contained herein shall not be used in whole or in part without the express written consent of Snap-on.

# Table of Contents

SAFETY INFORMATION.....	1
SAFETY INSTRUCTIONS .....	2
APPLY SYSTEM POWER.....	4
SHUT DOWN PROCEDURES.....	5
SYSTEM MAIN MENU .....	6
MAINTENANCE .....	7
START AN ALIGNMENT.....	8
SELECTING A VEHICLE.....	8
VEHICLE SUMMARY.....	9
VEHICLE POSITIONING SCREEN.....	10
CASTER.....	11
READINGS.....	13
FINAL READINGS.....	14
REPORTS .....	14
PORTABILITY.....	15
PREPARING FOR RELOCATION.....	15

---

---

## SAFETY INFORMATION

For your safety, read this manual thoroughly before operating the equipment.

The Aligner is intended for use by properly trained skilled automotive technicians. The safety messages presented in this section and throughout the manual are reminders to the operator to exercise extreme care when performing wheel alignments with this product.

There are many variations in procedures, techniques, tools, and parts for servicing vehicles, as well as the skill of the individual doing the work. Because of the vast number of vehicle applications and potential uses of the product, the manufacturer cannot possibly anticipate or provide advice or safety messages to cover every situation. It is the automotive technician's responsibility to be knowledgeable of the vehicle to be aligned. It is essential to use proper service methods and perform wheel alignments in an appropriate and acceptable manner that does not endanger your safety, the safety of others in the work area or the equipment or vehicle being serviced.

It is assumed that, prior to using the Aligner, the operator has a thorough understanding of the vehicle systems being serviced. In addition, it is assumed he has a thorough knowledge of the operation and safety features of the alignment rack or lift, and has the proper hand and power tools necessary to perform wheel alignments.

When using your garage equipment, basic safety precautions should always be followed, including:

1. Read all instructions.
2. Care must be taken as burns can occur from touching hot parts.
3. The socket-outlet (wall outlet) shall be located near the equipment and shall be easily accessible.
4. Do not operate power tools or equipment with a damaged power cord or if the equipment has been dropped or damaged until it has been examined by a qualified serviceman.
5. Do not let cord hang over edge of table, bench or counter or come in contact with hot manifolds or moving fan blades.
6. If an extension cord is necessary, a cord with a current rating equal to or more than that of the equipment should be used. Cords rated for less than the equipment may overheat. Care should be taken to arrange the cord so that it will not be tripped over or pulled.
7. Always unplug equipment from electrical outlet when not in use. Never use the cord to pull the plug from the outlet. Grasp plug and pull to disconnect.
8. Let equipment cool completely before putting away. Loop cord loosely around equipment when storing.
9. To reduce the risk of fire, do not operate equipment in the vicinity of open containers of flammable liquids, such as gasoline.
10. Adequate ventilation should be provided when working on operating internal combustion engines.
11. Keep hair, loose clothing, fingers, and all parts of body away from moving parts.
12. To reduce the risk of electrical shock, do not use on wet surfaces or expose to rain.
13. Use only as described in this manual. Use only manufacturer's recommended attachments.
14. ALWAYS WEAR SAFETY GLASSES. Everyday eyeglasses only have impact resistant lenses, they are NOT safety glasses.
15. Know and understand the proper operating procedures for all power tools used.
16. *Caution:* Risk of explosion if any battery is replaced by an incorrect type. Dispose of used batteries according to local and state government regulations.

**IMPORTANT!! SAVE THESE INSTRUCTIONS  
DO NOT DISCARD!!**

---

## SAFETY INSTRUCTIONS

### IMPORTANT!! SAVE THESE INSTRUCTIONS



Risk of electrical shock.

- **Do not operate equipment with a damaged power cord or if the equipment has been dropped or damaged, until it has been examined by a qualified service person.**
- **If an extension cord is necessary, a cord with a current rating equal to or greater than that of the equipment should be used. Cords rated for less current than the equipment can over-heat.**
- **Unplug equipment from electrical outlet when not in use. Never use the cord to pull the plug from the outlet. Grasp plug and pull to disconnect.**
- **Do not expose the equipment to rain. Do not use on wet surfaces.**
- **Plug unit into correct power supply.**
- **Do not remove or bypass grounding pin.**

*Contact with high voltages can cause death or serious injury.*



Risk of electrical shock. High voltages are present within the console unit.

- **There are no user serviceable items within the console other than the keyboard and printer.**
- **Service on the unit must be performed by qualified personnel.**
- **Do not open any part of the console other than noted areas.**
- **Turn power switch off and unplug the unit before servicing.**

*Contact with high voltages can cause death or serious injury.*



Risk of eye injury. Debris, dirt, and fluids may drop from vehicles.

- **Knock off any loose debris. Clean surfaces as needed to avoid any materials from falling.**
- **Wear approved safety glasses when servicing.**

*Debris, dirt, and fluids can cause serious eye injury.*



Risk of crushing. Vehicles may roll off alignment lift if not secured.

- **Leave automatic transmission in park or manual transmission in gear unless equipment operation steps require vehicle in neutral.**
- **Apply parking brake unless equipment operation steps require wheel movement.**
- **Use wheel chocks whenever vehicle is positioned on the lift.**
- **Follow rack or lift manufacturer's safety recommendations when lifting a vehicle.**

*Vehicles rolling off lifts can cause death or serious injury.*



Risk of entanglement or crushing. There are moving parts on vehicle lifts during operation.

- **Keep all persons clear of lifts.**
- **Read lift manufacturer's operation instructions carefully.**
- **Follow lift manufacturer's safety recommendations.**

*Contact with moving parts could cause injury.*



Risk of pinching or crushing body parts when jacking vehicles.

- **Keep hands and other body parts away from jacking surfaces.**
- **Do not use unapproved adapters (i.e. wooden blocks) when jacking a vehicle.**
- **Do not bypass any jack manufacturer's safety features.**
- **Read jack manufacturer's operation instructions carefully.**
- **Follow jack manufacturer's safety recommendations.**

*Improperly used or maintained jacks can cause injury.*



Risk of burns.

- **Do not touch hot exhaust systems, manifolds, engines, radiators, etc.**
- **Wear gloves whenever performing a service near hot components.**

*Hot components can cause burns.*



Risk Of Explosion.

- **This equipment has arcing or sparking parts which should not be exposed to flammable vapors.**
- **This equipment should be located at least 460mm/18inches above the floor, and not in a recessed area.**
- **Do not operate with the cover of the electrical box removed.**
- **Do not remove/alter grounding wires.**



Risk of pinching when camera beams and/or pods are in motion

- **Keep hands and other body parts away from camera beams and/or pods when they are in motion**



Risk of injury. Tools may break or slip if improperly used or maintained.

- **Use the correct tool for the task.**
- **Frequently inspect, clean, and lubricate (if recommended) all tools.**
- **Follow recommended procedures when performing vehicle services.**

*Tools that break or slip can cause injury.*

---

## APPLY SYSTEM POWER

1. Ensure that a properly grounded outlet is used. Failure to use proper voltage can and will result in a system failure.
2. The main power switch is located on the front inside of the Console. Open the front door of the cabinet. Look at the upper left inside and locate the green toggle switch. With power connected the switch will illuminate.
3. When the power switch is turned on, the unit initiates the cortex boot-up. The Home screen will appear next as the software finishes loading.



This boot sequence will take a few moments. If any problems are encountered during the Power On boot-up sequence, consult the service representative in your area. The unit may become unresponsive in the event of a severe power fluctuation such as Electrical Fast Transients or Electrostatic Discharge. To restore the unit to operating condition, turn off all power switches, wait 10 seconds, and turn them back on. If the unit is still unresponsive contact a qualified service technician for repairs.

## SHUT DOWN PROCEDURES

It is recommended that the system be shut down using this procedure. Although powering down the system by directly shutting off the power switch has been used, the “Shut Down” procedure ensures the Host Controller is properly powered down. After shutting down the software, the switch(s) must be toggled off to remove electrical power from the Host Controller (cabinet).

1. From the Main Menu click on “Shut Down”.

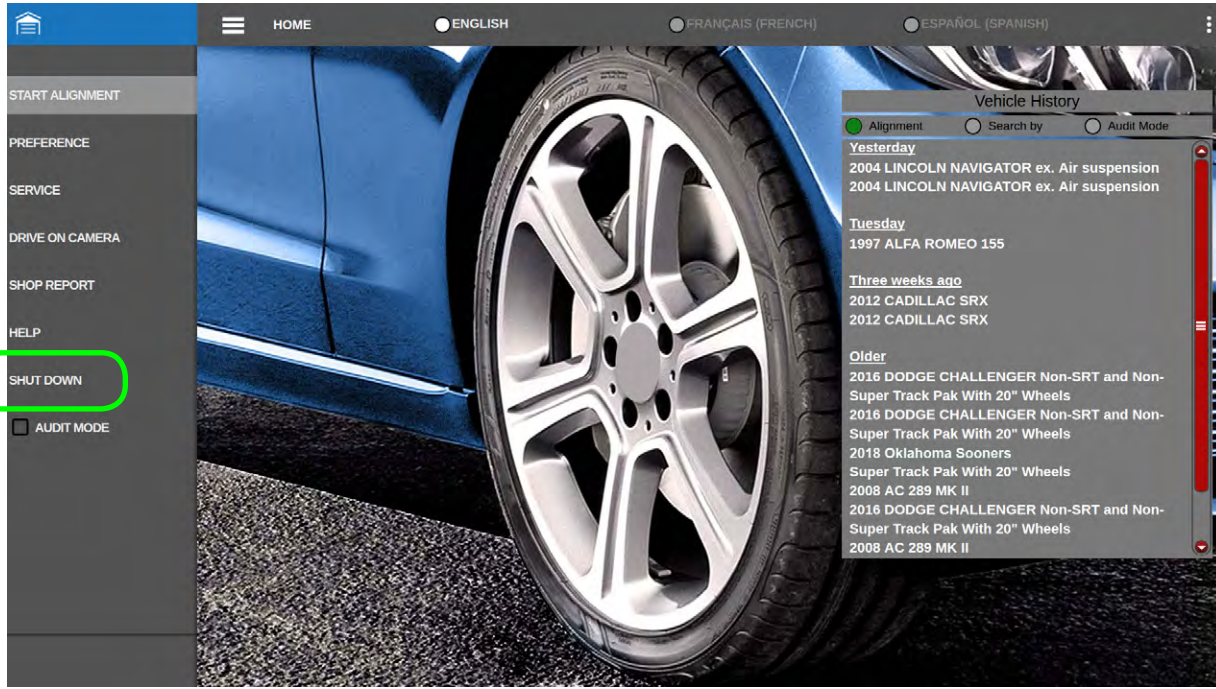

2. The user is given approximately 10 seconds to abort the unit Shut Down process by clicking on the <BACK> button.

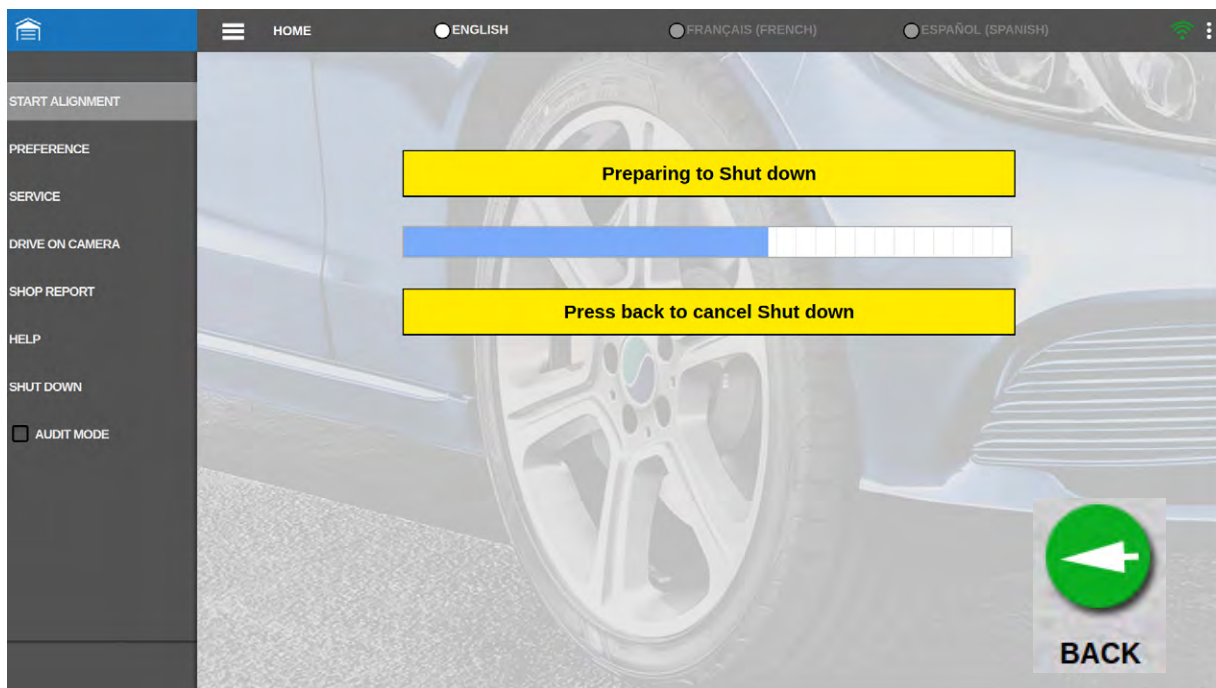



## SYSTEM MAIN MENU

All system usage resides from the Home Screen. Each function of the aligner will be followed with screen prompts. The user needs to simply click a command and the aligner will easily prompt the user to the next step. No guessing required as the system has been designed with each user in mind.

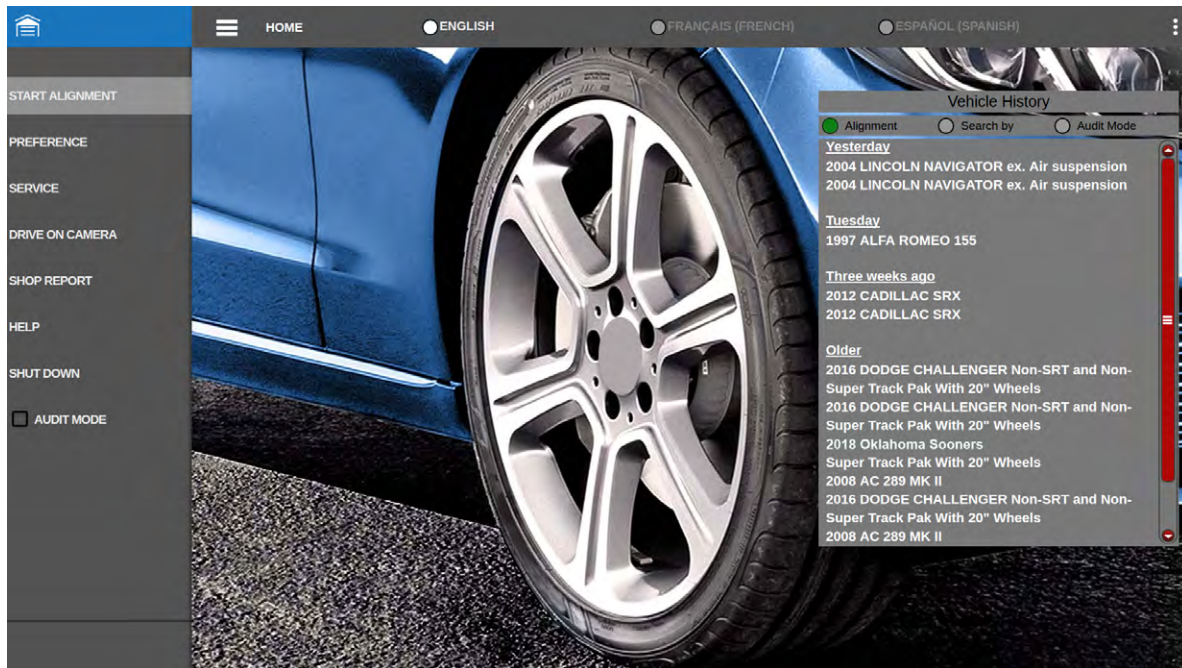

- **Start Alignment** - Begin an alignment process
- **Preferences** - A menu to setup the aligner for desired user interaction
- **Service** - Choose to access the local or network server, access the Calibration sub menu and several diagnostic screens
- **Drive on Camera** - Feature allows the user to use the aid of a camera to assist the user when pulling onto the rack.
- **Shop Report** - Allow the user to retrieve and print alignment reports.
- **Help** - Select to display assistance for the selected screen.
- **Shut Down** - Used to shut the software before disconnecting power.
- Audit Mode** - Quick Alignment Check.

**NOTE: THE "MENU" PULL OUT TAB IS AVAILABLE ON MOST PAGES TO ALLOW YOU ACCESS OF IMPORTANT SCREENS REGARDLESS WHERE YOU ARE IN THE ALIGNMENT PROCESS.**



---

**MAINTENANCE**

Service of an aligner requires extreme care and knowledge. Service should be performed only by a qualified service technician.

- Always check equipment for damaged parts before use.
- Replace or repair damaged parts before use. Check alignment of moving parts. Binding of moving parts or broken parts may alter operation.
- Have damaged parts properly repaired or replaced by an Authorized Service Center.
- Do not use equipment if switch does not turn it on and off.
- Maintain equipment. Keep equipment dry, clean and free of oil and grease for better and safer performance.
- Clean the glass surfaces of all targets once a week with an ammonia-free cleaner and a lint-free cloth.
- Lightly lubricate the lead screw on the wheel clamps once a month with machine oil.
- Lightly lubricate the rubber o-rings on the wheel clamp claws once a month with machine oil.
- For the location of the nearest Snap-on repair center, call Snap-on customer service.

**WARNING**

- Use safety equipment, Always wear eye protection.
- Wear safety gloves as necessary to protect hands.
- Not for outdoor use exposed to rain or heavy condensation

**INFORMATION:**

Should the system become unresponsive in the event of a severe power fluctuation such as Electrical Fast Transients or Electrostatic Discharge. To restore the unit to operating condition, turn off all power switches, wait 10 seconds, and then turn back on.

## PORTABILITY

The Aligner was designed with multiple bay capability. With its unique Camera Foldup system an Operator can simply fold up the Camera Arms, unlock the smooth mobility wheels and roll the system to a different bay to perform fast and accurate alignments. Before moving the system to a different bay please follow the simple steps listed below before moving the system.

**CAUTION!**  
NEVER RELOCATE THE ALIGNER WITH THE CAMERA ARMS FOLDED OUT IN THE ALIGNMENT MODE.  
  
NEVER MOVE THE SYSTEM USING THE CAMERA ARMS

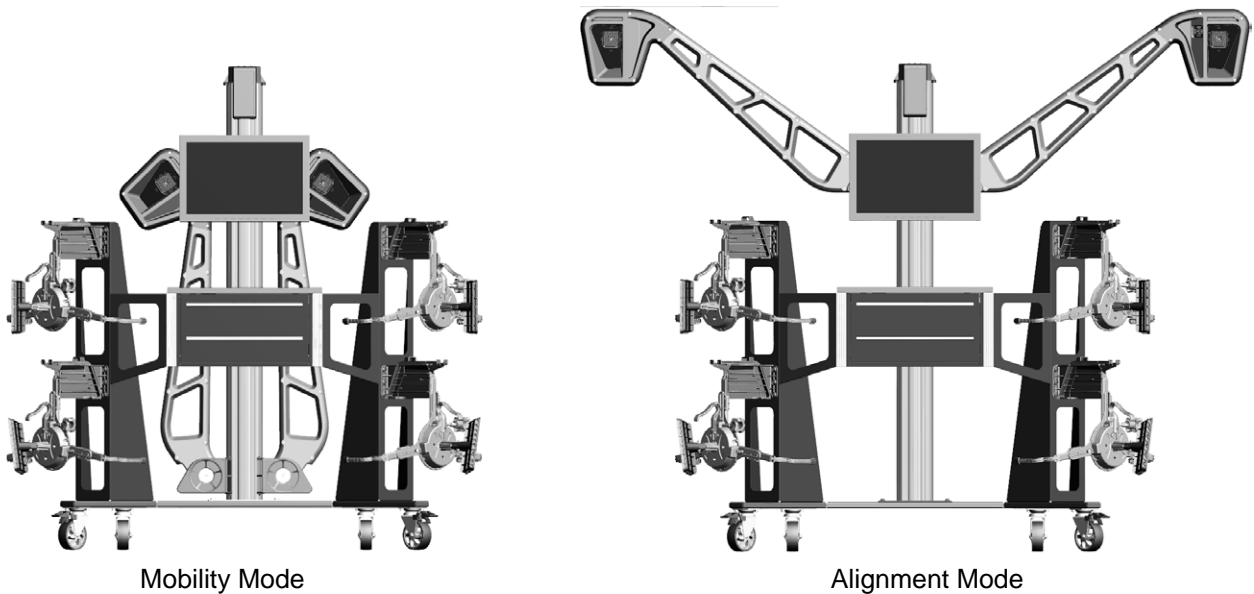

### PREPARING FOR RELOCATION

Before moving the alignment system it is recommended that the camera arms be in their lowest most position.

1. From the Home screen select "Service".

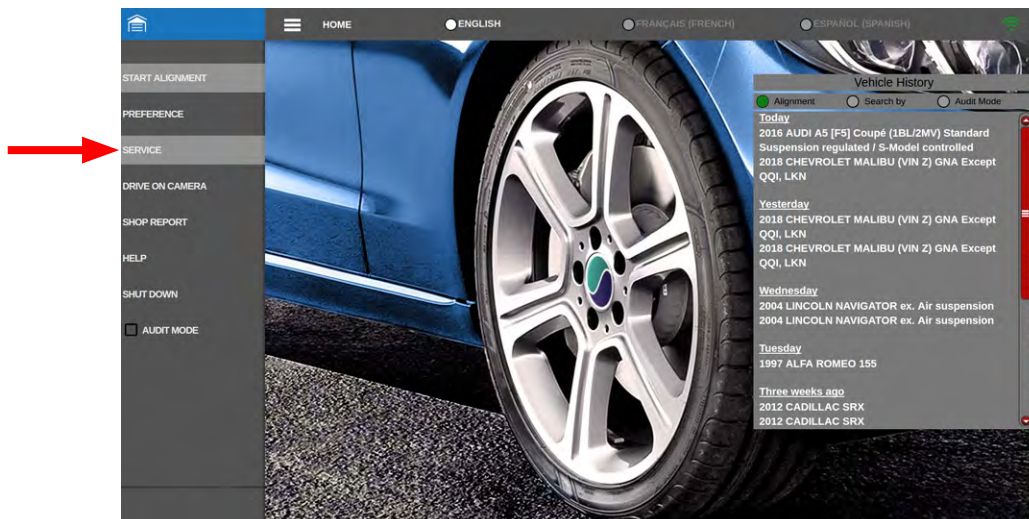

2. From the Service Menu select “Camera Diagnostic”.

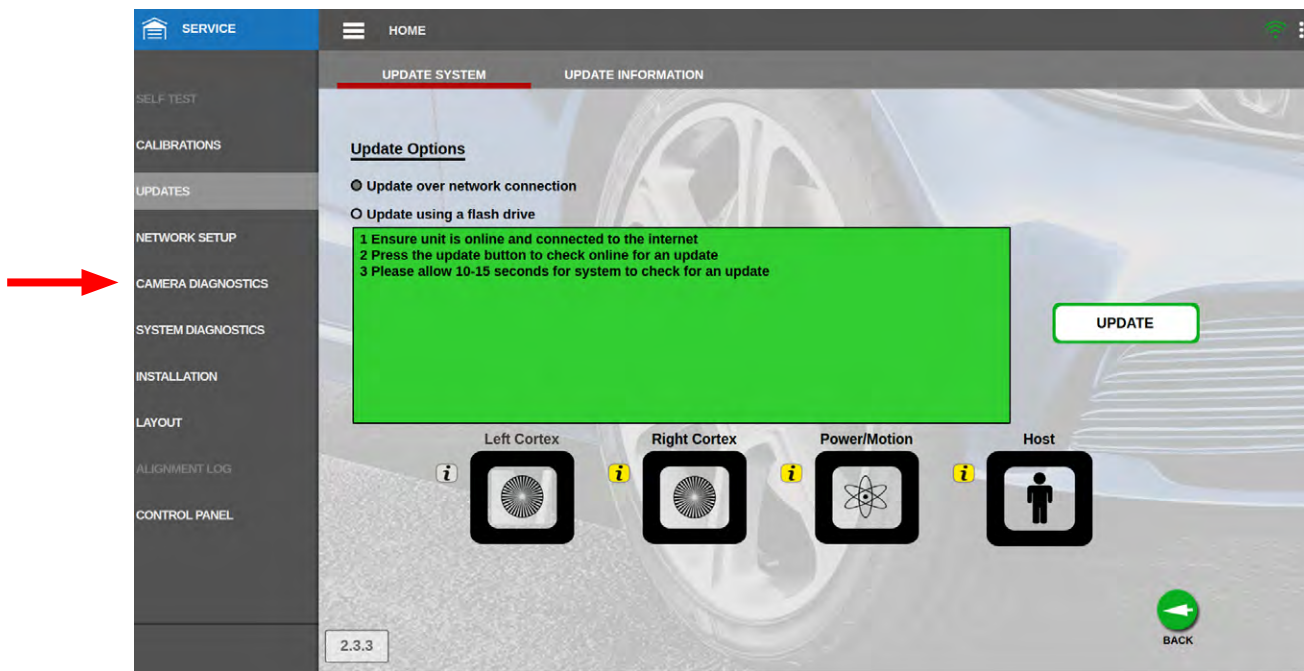

3. Click the “Manual” button. Using the pointing device click on the GREEN DOWN arrow. Continually click on the arrow until the camera arms are at their lowest position.

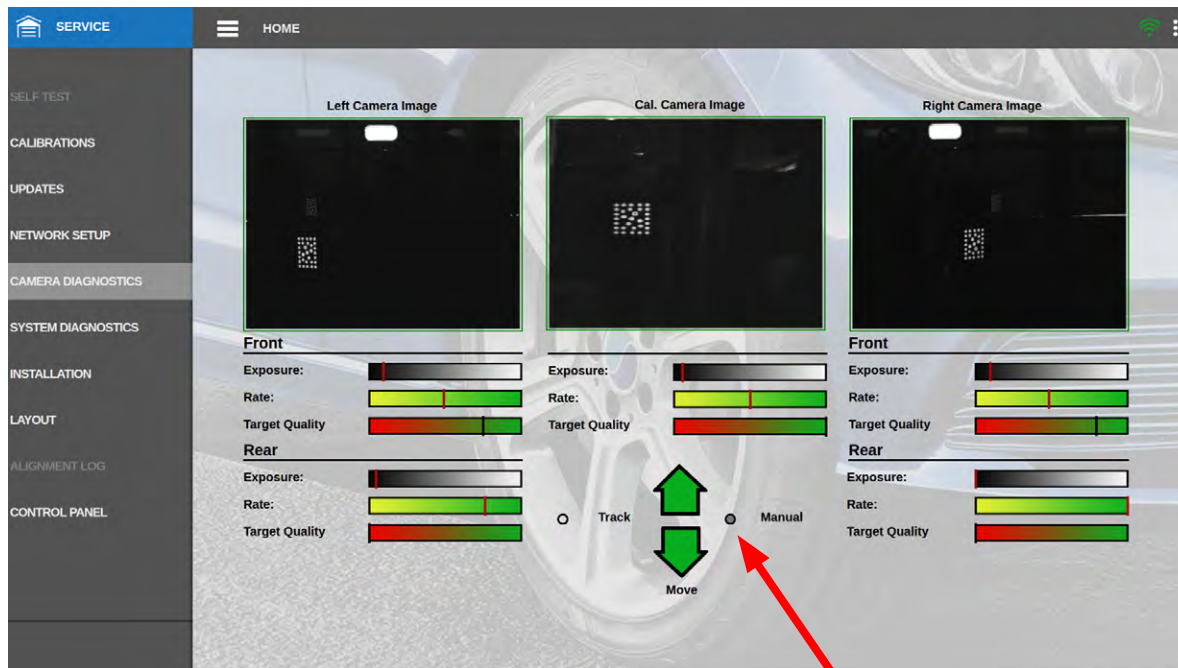

4. Once the camera’s have reached their lowest position follow the procedures for properly powering down the system.



## Portability

5. From the back of the system gently push up on the camera (indicated by red arrows) arms to the mobility positions.
6. Once the camera arm(s) have been properly folded the holding pins will automatically lock the cameras in the mobility position.

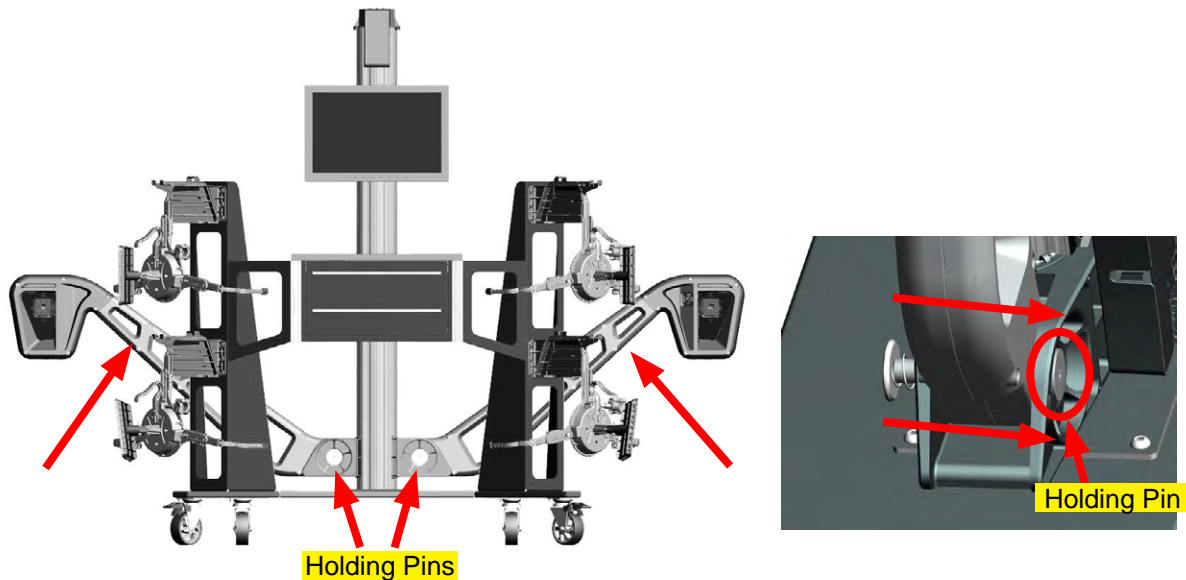

7. Once both Camera arms have been locked in the Mobility Mode, unlock both front wheels on the mobility cart and relocate the system to a different bay.
8. Please follow the installation instructions to properly square the system in the new bay.
9. Follow the "Power Up" sequence mentioned earlier in this quick start.
10. To lower the camera arms remove the pressure from the arms by pushing the cameras in the direction of the arrows and pulling the holding pins. Carefully lower the cameras down. Once lowered to the alignment position, the locking pins will not lock. This will allow the camera arms freedom should there be an obstruction below them during the alignment process. There will be no need to manually raise the carriage system as the system will automatically self-track once the alignment process is started.

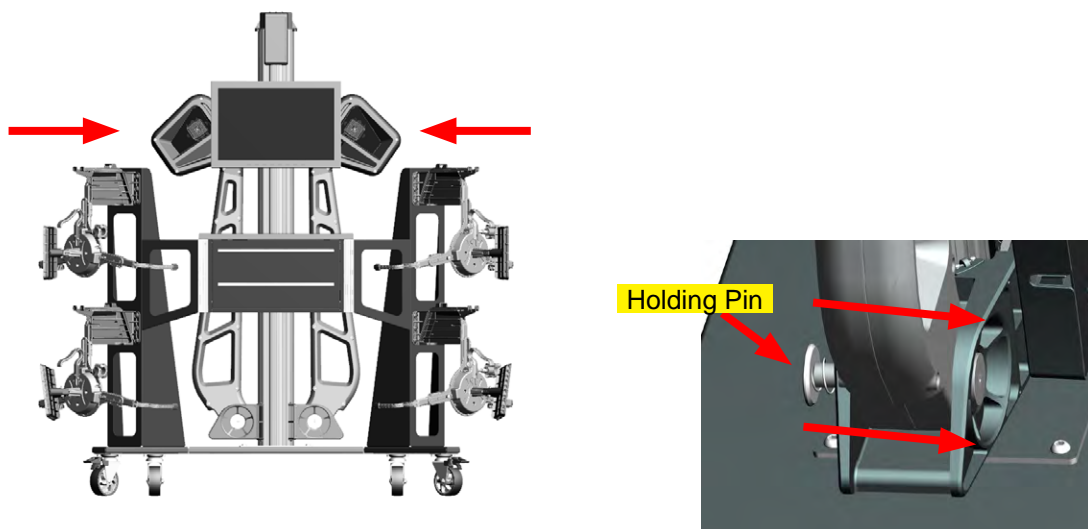

## START AN ALIGNMENT

### SELECTING A VEHICLE

Before beginning the alignment the vehicle being serviced should be selected from the database so the machine can reference the manufacturers specifications.

First select Make of the vehicle

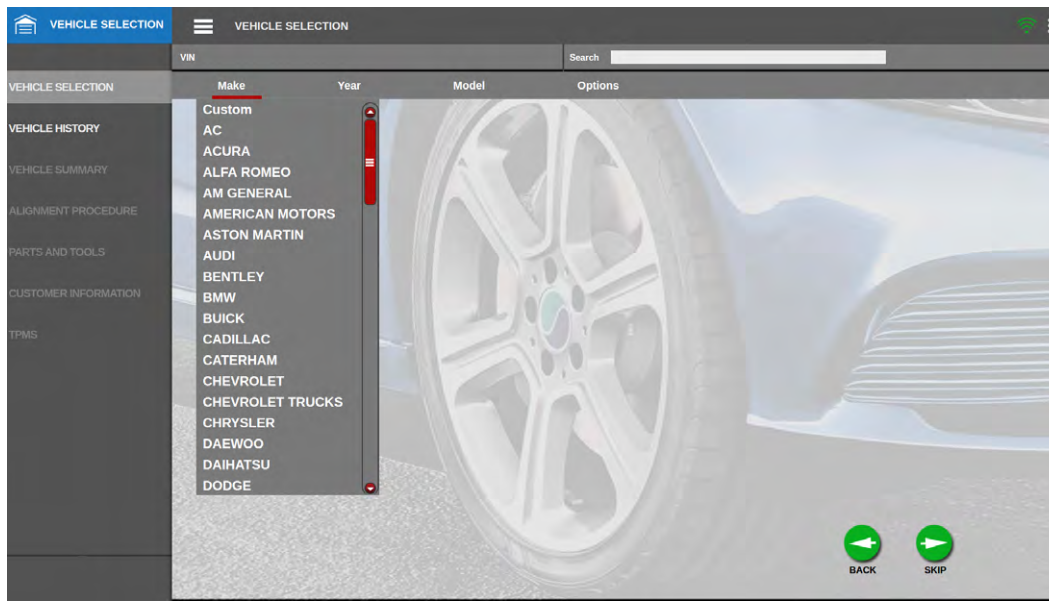

Next select the Year of vehicle



Select the Model



Then select Options if applicable. Vehicle Options are usually listed on a "Service Parts ID Label". This label is found on some vehicles on the spare tire cover, rear compartment, glove box or door post.

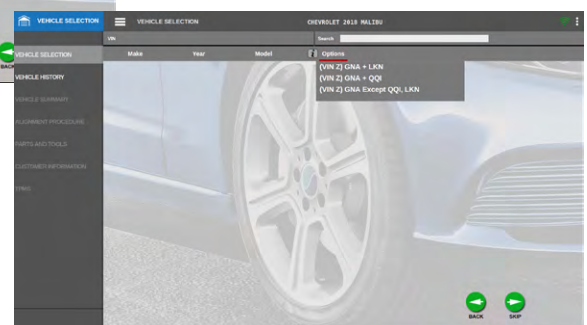

Select "Use Photo" to attach a photo of the vehicle to the alignment report, or click "Use Vehicle" to skip adding the photo.

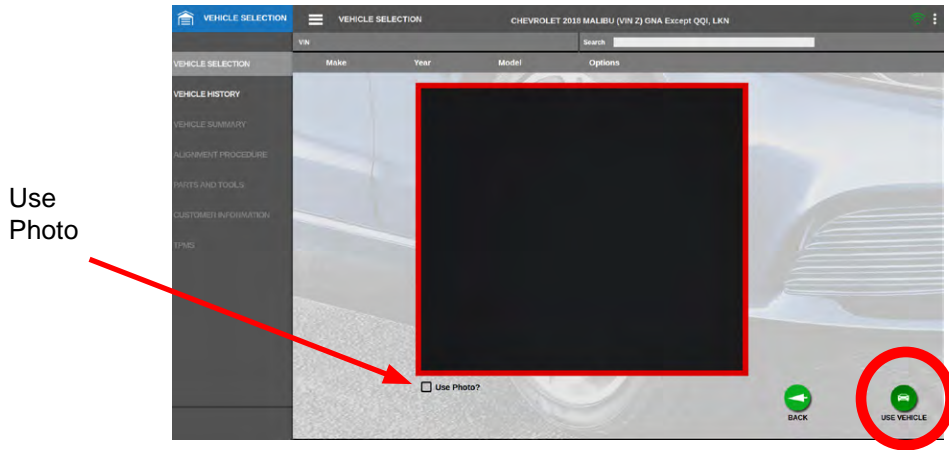

**VEHICLE SUMMARY**

The Vehicle Summary page displays the alignment specifications, any safety recalls and other special considerations required of the vehicle being aligned. Some considerations are: Vehicle loading, ride height requirements and if an SAS reset is required after adjustment. Click on "Start" to continue.

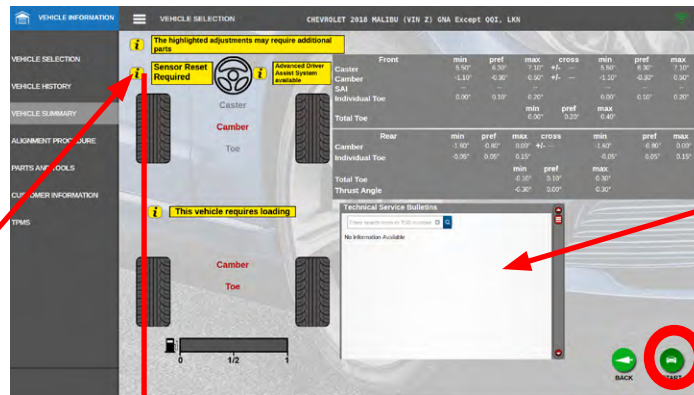

**NOTE: CLICKING ON AN "I" WILL GIVE A USER ADDITIONAL INFORMATION.**

With a subscription and cloud access, Vehicle specific information can be found here.

**NOTE: NOT ALL MARKETS HAVE MITCHELL 1 ACCESS. PLEASE CHECK WITH YOUR REPRESENTATIVE IN YOUR AREA.**

Clicking on underlined text will display additional information procedures.

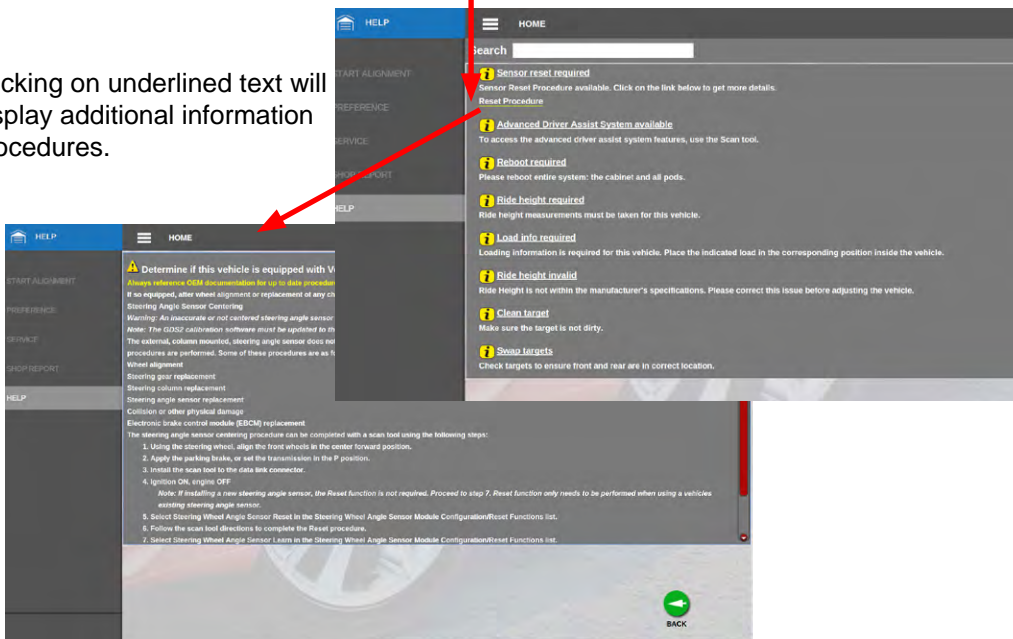



## VEHICLE POSITIONING SCREEN

The Vehicle Positioning screen displays an arrow that prompts you to move the vehicle forward. The graphic image on the screen follows the vehicle's movement as you roll the vehicle in the direction indicated. When the arrow turns red, stop.

**NOTE: THE WHEEL CLAMP TYPE DICTATES THE DIRECTION OF THE ROLLBACK**

Move the vehicle rearward as indicated. The arrow will again turn red when the correct position is reached.

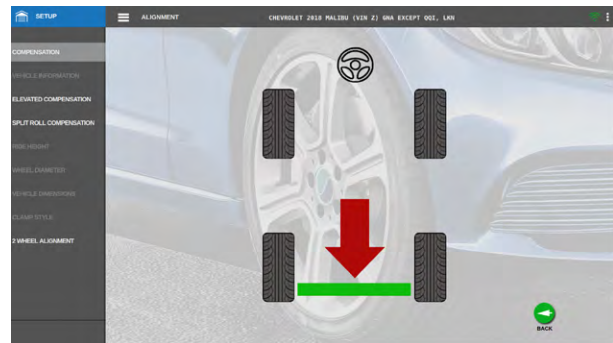
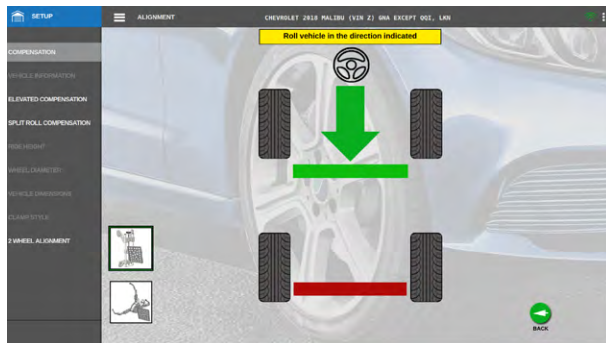

Move the vehicle forward again to the indicated position.

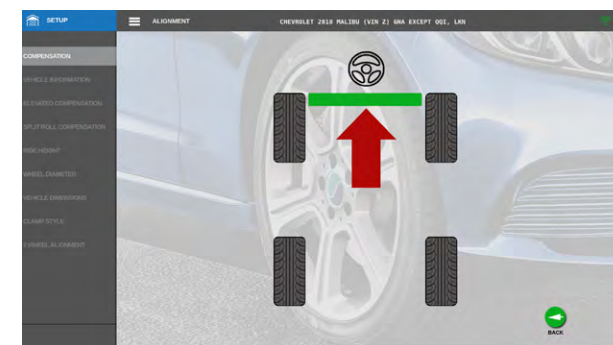
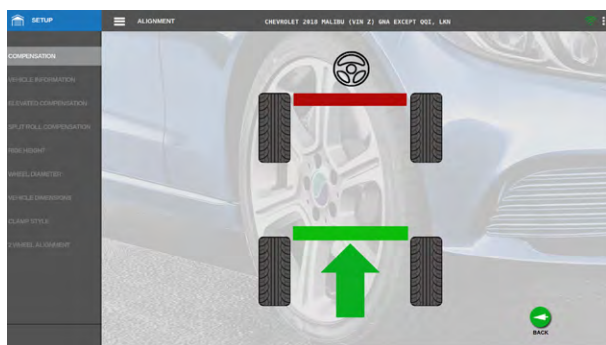

Once the vehicle has returned to the start position, compensation is complete. If changes were detected in one or more suspension angles the screen will alert the user to roll the vehicle to relieve stress and then to perform compensation again. Click the **"BACK"** button to re-do rollback or **"SKIP"** to proceed. Please note that skipping the error may give incorrect alignment readings.

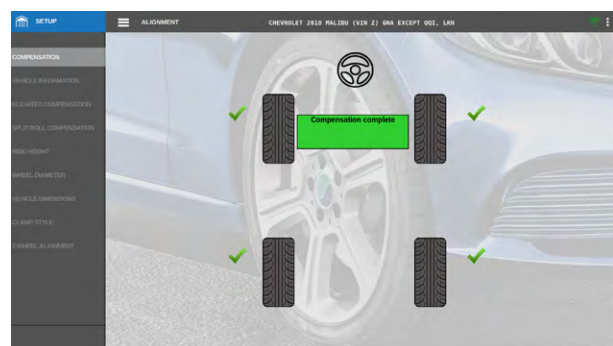
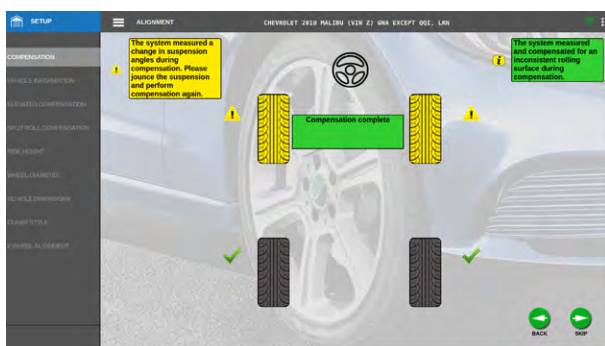

If there are no errors the system will display 4 wheel check marks and auto advance. Green check marks indicate a good positioning has been achieved.



## CASTER

Prior to measuring caster you will be prompted to perform several necessary tasks:

1. **Start the vehicle**
2. **Install the brake pedal depressor**
3. **Turn off the vehicle**
4. **Unlock the turntable and rear slip plates**
5. **Center the steering.**

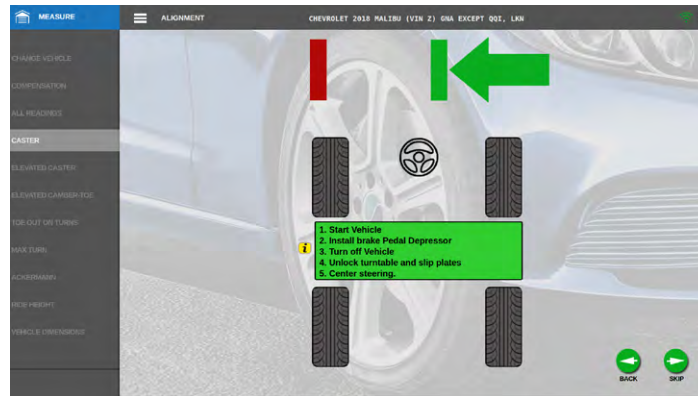

Steer the wheels to the direction indicated. When you have reached the desired angle the arrow will turn red and the bar turns green.

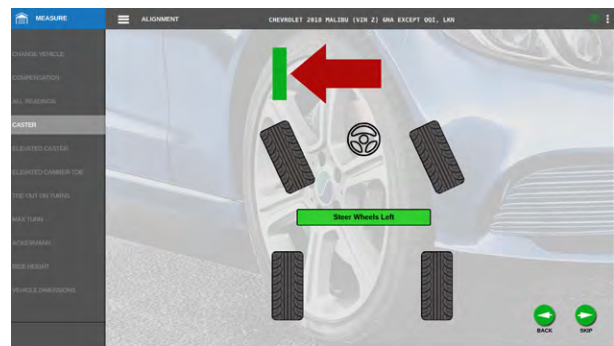

Steer the wheels in the opposite direction.

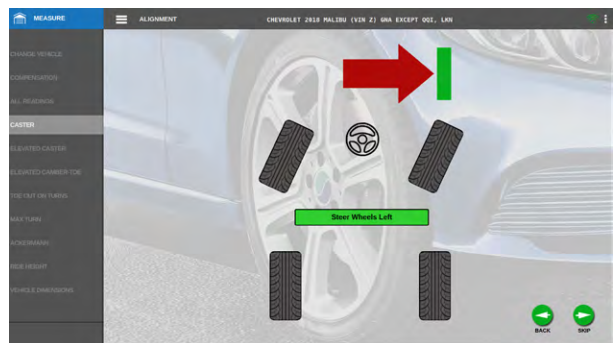

When you have reached the desired angle the arrow will turn red and the bar turns green.

Steer back to center. When the wheels are centered the position bar turns to green and the direction arrow will turn red to indicate correct position.

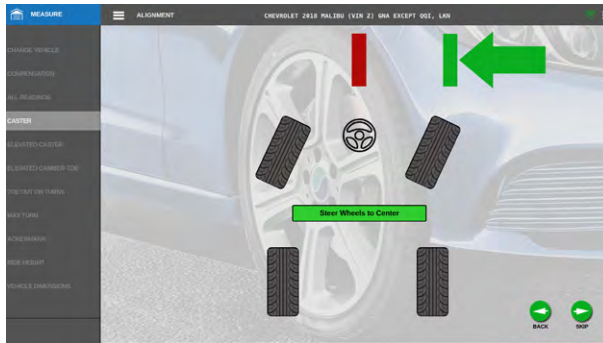

Level the steering wheel. The system will auto advance.

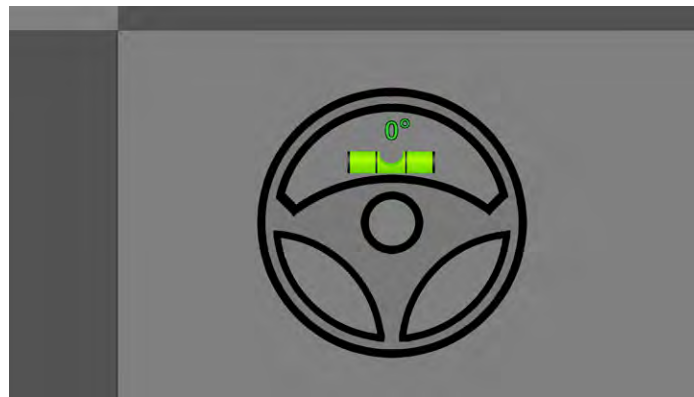

## READINGS

This screen illustrates all readings for both front and rear. The primary use for the Readings Screen is for the User to determine if the vehicle requires an alignment. Readings are live “Real Time” values indicating a green or red color if the value is “In” or “Out” of specification respectively. Grey bars indicate that no manufactured vehicle specifications are provided.

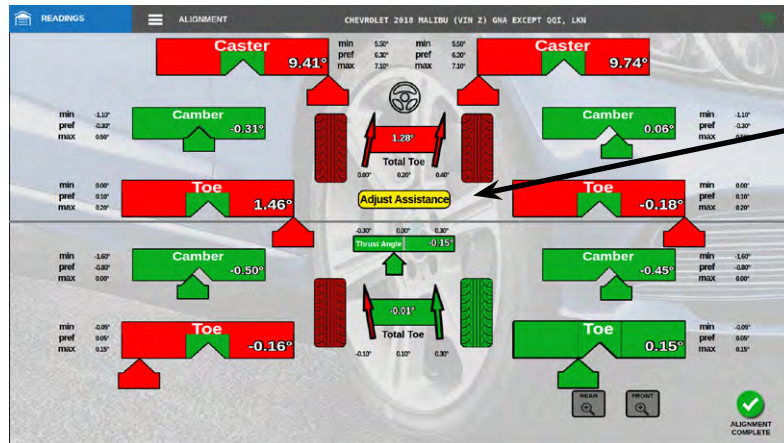

Alignment Assistance  
Appears in yellow in  
center of screen.

Specifications for the vehicle under test are shown on the screen with minimum, maximum and preferred values. The actual live value is shown inside the measurement block. Cross values, total toe and thrust angle are displayed in the center of the screen.

Readings that are in specification displays the pointer in green, while those out of specification are colored red.

As you adjust the vehicle for proper alignment the pointer moves indicating the direction of adjustment. The indicator pointer will turn green when it begins to “Nest” in the preferred range of specifications. A near perfect value will show to be fully nested.

**NOTE: THE “MENU” PULL OUT TAB IS AVAILABLE ON MOST PAGES TO ALLOW YOU ACCESS OF IMPORTANT SCREENS REGARDLESS WHERE YOU ARE IN THE ALIGNMENT PROCESS.**

From the Menu pull out tab, click on the “**Measurements**” or “**Adjustments**” menu to access all alignment measure and adjust procedures including those below and many more.

- Change Vehicle** - Select different vehicle
- Compensation** - Rollback
- Readings** - Display live readings
- EZ Toe** - Toe adjustment feature
- Caster** - Perform Caster Measurement
- Elevated Adjust** - Adjust vehicle elevated
- Measurement** - Measure Vehicle angles
- Adjustments** - Adjust vehicle angles
- Vehicle Information** - Manufacture vehicle information
- System Status** - Alignment System information

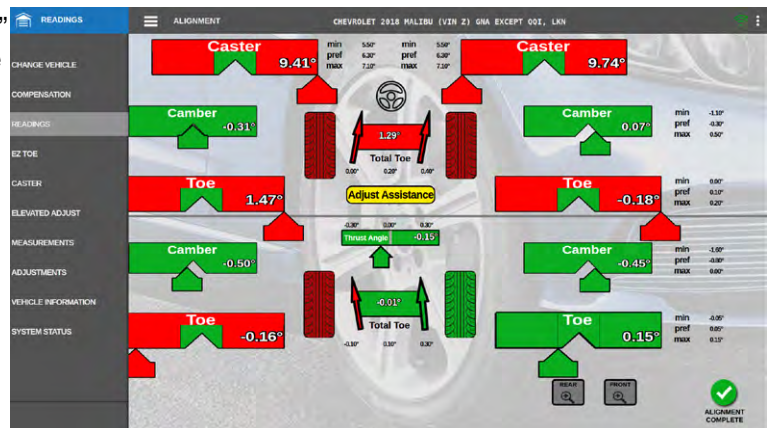

Click “**Alignment Complete**” to store the values.

## FINAL READINGS

This screen displays the completed angles for the vehicle tested. Click "Done" to continue to the Reports page.

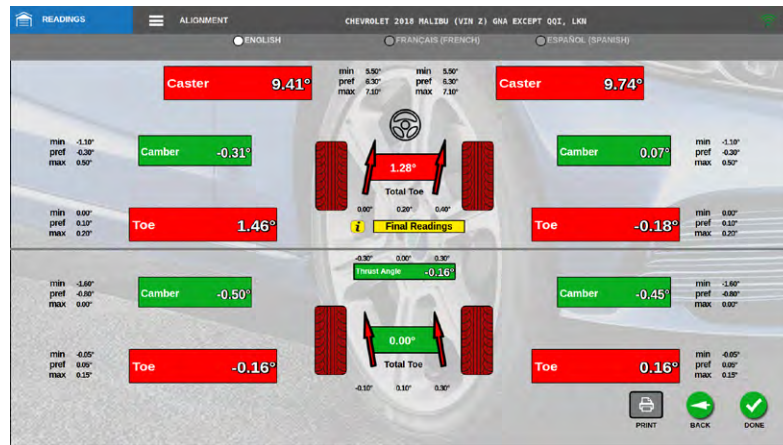

## REPORTS

At the Completion of the alignment process several printable reports are available. Use the scroll bar to view the selections. The selected report is shown in the preview window in the center of the screen. The current time of the alignment duration is displayed to the right. Select "PRINT" to print the selected report or "HOME" to save the alignment and return to the Home screen.

Select the print language to be used here.

Select "Customer Info" to enter information about the customer and or vehicle.

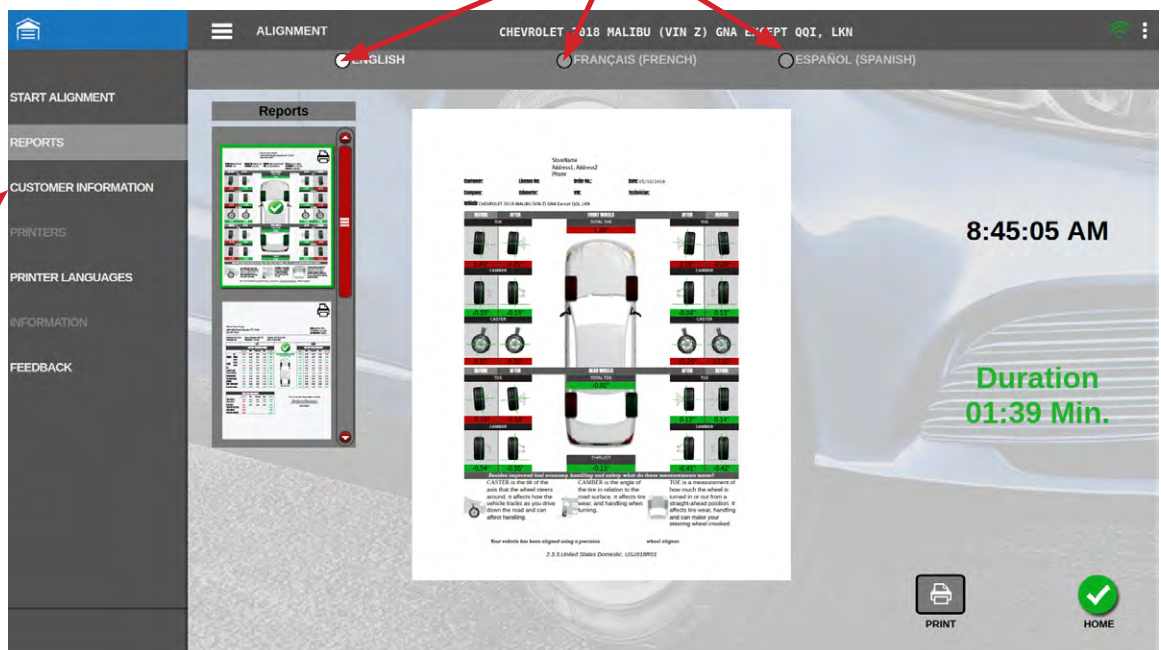

Blank Page

Blank Page



---

## USA

Snap-on  
309 Exchange Avenue  
Conway, Arkansas 72032  
Tel.: (800) 225-5786

## CANADA

Snap-on  
6500 Millcreek Drive  
Mississauga, Ontario  
Canada L5N 2W6  
Tel: (905) 814-0114  
Fax: (905) 814-0110

## Italy

**Snap-on Equipment S.r.L.**  
Via Provinciale per Carpi 33,  
42015 Correggio (R.E.), Italy  
Tel. ++39 (0)522 733480  
Fax: ++39 (0)522 733479

## EUROPE MIDDLE EAST AFRICA JAPAN

Snap-on Equipment s.r.l. · Via Prov. Carpi, 33  
42015 Correggio (RE) Italy  
Phone: +39 0522 733 411 · Fax: +39 0522 733 479  
[www.snapon-equipment.eu](http://www.snapon-equipment.eu)

## France

Snap-on Equipment France  
ZA du Vert Galant · 15, rue de la Guivemone BP97175,  
ST Ouen L'Aumone · 95056 Cergy Pontoise Cedex  
Phone: +33 (0) 1 3448 5878 · Fax: +33 (0) 1 3448 5870  
[www.snapon-equipment.fr](http://www.snapon-equipment.fr)

## Germany

Snap-on Equipment GmbH · Konrad-Zuse-Straße 1  
84579 Unterneukirchen  
Phone: +49 (0) 8634 6220 · Fax: +49 (0) 8634 5501  
[www.snapon-equipment.de](http://www.snapon-equipment.de)

## United Kingdom

Snap-on Equipment Ltd. · 48 Sutton Park Avenue  
Reading RG6 1AZ  
Phone: +44 (0) 118 929 6811 · Fax: +44 (0) 118 966 2922  
[www.snapon-equipment.co.uk](http://www.snapon-equipment.co.uk)

---

**Notice:** The information contained in this document is subject to change without notice. **Snap-on** makes no warranty with regard to this material, shall not be liable for errors contained herein or for incidental consequential damages in connection with furnishings, performance, or use of this material.

This document contains proprietary information which is protected by copyright and patents. All rights are reserved. No part of this document may be photocopied, reproduced, or translated without prior written consent of **Snap-on**.