

# ***Motorized Truck Balancer***

---

Operation manual

Wheel balancer for truck wheels



## IMPORTANT SAFETY INSTRUCTIONS

When using your garage equipment, basic safety precautions should always be followed, including the following:

1. Read all instructions.
2. Care must be taken as burns can occur from touching hot parts.
3. Do not operate equipment with a damaged cord or if the equipment has been dropped or damaged - until it has been examined by a qualified serviceman.
4. Do not let cord hang over edge of table, bench, or counter or come in contact with hot manifolds or moving fan blades.
5. If an extension cord is necessary, a cord with a current rating equal to more than that of the equipment should be used. Cords rated for less current than the equipment may overheat. Care should be taken to arrange the cord so that it will not be tripped over or pulled.
6. Always unplug equipment from electrical outlet when not in use. Never use the cord to pull the plug from the outlet. Grasp plug and pull to disconnect.
7. Let equipment cool completely before pulling away. Loop cord loosely around equipment when storing.
8. To reduce the risk of fire, do not operate equipment in the vicinity of open containers of flammable liquids (gasoline).
9. Adequate ventilation should be provided when working on operating internal combustion engines.
10. Keep hair, loose clothing, fingers, and all parts of body away from moving parts.
11. To reduce the risk of electric shock, do not use on wet surfaces or expose to rain.
12. Use only as described in this manual. Use only manufacturer's recommended attachments.
13. **ALWAYS WEAR SAFETY GLASSES.** Everyday eyeglasses only have impact resistant lenses, they are NOT safety glasses.

**SAVE THESE INSTRUCTIONS**

**DISCLAIMER OF WARRANTIES AND LIMITATIONS OF LIABILITIES**

While the authors have taken care in the preparation of this manual, nothing contained herein:

- modifies or alters in any way the standard terms and conditions of the purchase, lease or rental agreement under the terms of which the equipment to which this manual relates was acquired,
- increases in any way the liability to the customer or to third parties.

**TO THE READER**

While every effort has been made to ensure that the information contained in this manual is correct, complete and up-to-date, the right to change any part of this document at any time without prior notice is reserved.

---

**Before installing, maintaining or operating this unit, please read this manual carefully, paying extra attention to the safety warnings and precautions.**

---

## Table of Contents

<b>Safety</b> .....	<b>5</b>
1.1 <b>Typographical conventions</b> .....	<b>5</b>
2.0 <b>Specifications.</b> .....	<b>6</b>
2.1 <b>Conditions.</b> .....	<b>6</b>
3.1 <b>Accessories.</b> .....	<b>8</b>
3.2 <b>Optional Accessories</b> .....	<b>9</b>
4.0 <b>Layout.</b> .....	<b>10</b>
4.1 <b>The display.</b> .....	<b>11</b>
4.2 <b>The input panel</b> .....	<b>12</b>
5.0 <b>Operation</b> .....	<b>14</b>
5.1 <b>Operation of the pneumatic loading device</b> .....	<b>14</b>
5.1.1 <b>Clamping a truck wheel</b> .....	<b>15</b>
5.1.2 <b>Clamping a car wheel</b> .....	<b>16</b>
5.2 <b>Preparation</b> .....	<b>17</b>
5.2.1 <b>Power up</b> .....	<b>17</b>
5.2.2 <b>Emergency stop</b> .....	<b>17</b>
5.2.3 <b>Shutting down</b> .....	<b>18</b>
5.2.4 <b>Settings</b> .....	<b>18</b>
5.3.2 <b>Balancing</b> .....	<b>19</b>
5.3.2.1 <b>Normal weight mode</b> .....	<b>19</b>
5.3.2.2 <b>ALU weight modes</b> .....	<b>19</b>
5.3.2.3 <b>Alu2P and Alu3P (HWM) mode</b> .....	<b>20</b>
5.3.2.4 <b>Static balancing</b> .....	<b>20</b>
5.3.2.5 <b>Internal Balancing</b> .....	<b>21</b>
5.3.3 <b>Spinning the Wheel</b> .....	<b>21</b>
5.3.4 <b>Weight application</b> .....	<b>22</b>
5.3.5 <b>Check spin</b> .....	<b>24</b>
5.3.6 <b>Results recalculation</b> .....	<b>24</b>
5.3 <b>Balancing procedure</b> .....	<b>25</b>
5.3.1 <b>Rim data input</b> .....	<b>26</b>
5.4 <b>Special modes</b> .....	<b>28</b>
5.4.1 <b>Split Weight Mode</b> .....	<b>28</b>
5.4.2 <b>Balancing optimisation / Weight minimisation</b> .....	<b>28</b>
5.5 <b>Special functions</b> .....	<b>37</b>
5.5.1 <b>Non-skid function</b> .....	<b>37</b>
5.6 <b>Calibration</b> .....	<b>38</b>
5.6.1 <b>User calibration</b> .....	<b>38</b>
5.7 <b>Selecting the operating mode</b> .....	<b>39</b>
6.0 <b>Maintenance</b> .....	<b>44</b>
7.0 <b>Troubleshooting</b> .....	<b>45</b>
8. <b>Instructions For Disposal</b> .....	<b>51</b>
9.0 <b>Appendices</b> .....	<b>51</b>
<b>Appendix: Installation Instructions</b> .....	<b>52</b>
iii <b>Installation procedures</b> .....	<b>55</b>
iv <b>Test procedures</b> .....	<b>57</b>
v <b>Instructing the operator</b> .....	<b>57</b>

May 2005 - Revision B note:  
 - Chapter 3.1: HNA accessories information, added

November 15 2006 - Rev D note:  
 Streamlined book to include only one language per pub. Spanish and French available on layers

April 2006 - **Revision C** note:  
 - Page2: Safety Information, added  
 - Chapter 8.1: New chapter implementation

November 29 2008 - Rev E note:  
 Created generic files for all channels

# 1 Safety

All Safety Precautions relevant to the unit are described in the Safety Booklet, refer to Figure 1 – 1.

The Safety Precautions should be fully understood and observed by every operator. We suggest you store (a copy) of the Safety Booklet near the unit, within easy reach of the operator.

The Operator's Manual will contain specific warnings and cautions when dangerous situations may be encountered during the procedures described.

## 1.1 Typographical conventions

This manual contains text styles intended to make the reader pay extra attention:

Note: Suggestion or explanation.

**CAUTION: INDICATES THAT THE FOLLOWING ACTION MAY RESULT IN DAMAGE TO THE UNIT OR OBJECTS ATTACHED TO IT.**

**WARNING: INDICATES THAT THE FOLLOWING ACTION MAY RESULT IN (SERIOUS) INJURY TO THE OPERATOR OR OTHERS.**

- Bulleted list:
- Indicates that action must be taken by the operator before proceeding to the next step in the sequence.



1-1

## 2.0 Specifications.

### Power:

Power Supply	115/120V AC, 0.3 kW, 50/60 Hz, 1 ph
Power consumption	2.0 A
Motor rating	0.25 kW
Mains fuses	2x IEC 127 T5A
Protection class	IP23

### Measurements:

Measuring time	< 20 s
Measuring speed	< 100 rpm
Offset	0-340 mm
Resolution:	(see Product Requirements table)

### Wheel dimensions:

Max. width	26" - 650 mm
Max. diameter	50" - 1300 mm
Max. weight	550lbs - 250 Kg
Rim width	76-510mm / 3-20"
Rim diameter:	205-635mm / 8-25"

### Shaft and cones:

Stub shaft diameter	40 mm
Light truck, cone	4.8"-6.85" 122 - 174 mm
Light truck, cone HNA	4.45"-6.7" 113 - 170 mm

### Dimensions:

Weight	562 lbs - 255 kg
Shipping weight	628lbs - 285 kg
Dimensions (hxdxw)	75.6"x54"x54.7"
	(1920x1370x1390 mm)
Shipping dimensions	57.9"x43.3"x50.4"
	(1470x1100x1280 mm)

### Miscellaneous:

Noise level	<70 db(A)
-------------	-----------

## 2.1 Conditions.

During use or long term storage, the conditions should never exceed:

Temperature range	32 - 122 °F (0-50 °C)
Humidity range	10-90 %, non condensing

### 3.0 Introduction.

This wheel balancer combines advanced, high-performance technology, robustness and reliability with very simple, user-friendly operation.

The low rotation speed of the wheel ensures that this balancer is very safe.

It is characterised by a display and input panel which are easy to use and guarantee rapid, intuitive operation. Operator time and effort are reduced to a minimum, while maintaining accuracy and reliability.

Always work in a clean area and with clean wheels, no dirt stuck in the tire or on the rim. That way proper mounting of the wheel and an optimal balancing result can be achieved.

#### **Application.**

The off-the-vehicle wheel balancer is designed for dynamic and static balancing of truck, light-truck and passenger car wheels, that fall within the limits stated in the technical specifications.

This is a high precision measuring device. Handle with care.

#### **Manuals for the unit.**

Information related to the unit is in:

- Operator's Manual (Chapter 1 – 9)  
The operator must be familiar with it.  
Before proceeding be familiar with the operation of the balancer.  
Read the Safety cautions.

### 3.1 Accessories.

Standard accessories for HNA (USA-CANADA only):

Figure 3.1-1.

- |   |                              |             |
|---|------------------------------|-------------|
| 1 | Basic centering device       | EAA0306D13A |
| 2 | Adaptor                      | EAA0260D32A |
| 3 | Centering cone 4 1/4-6 5/8"  | 6410648     |
| 4 | Distance ring                | EAA0277D59A |
| 6 | Hexagon socket head key SW14 | 1101013     |
| 7 | User Calibration weight      | EAM0005D40A |
| 8 | Quick-Nut                    | 6415899     |
| 9 | 4/5 Point Adaptor            | EAA0307G80A |

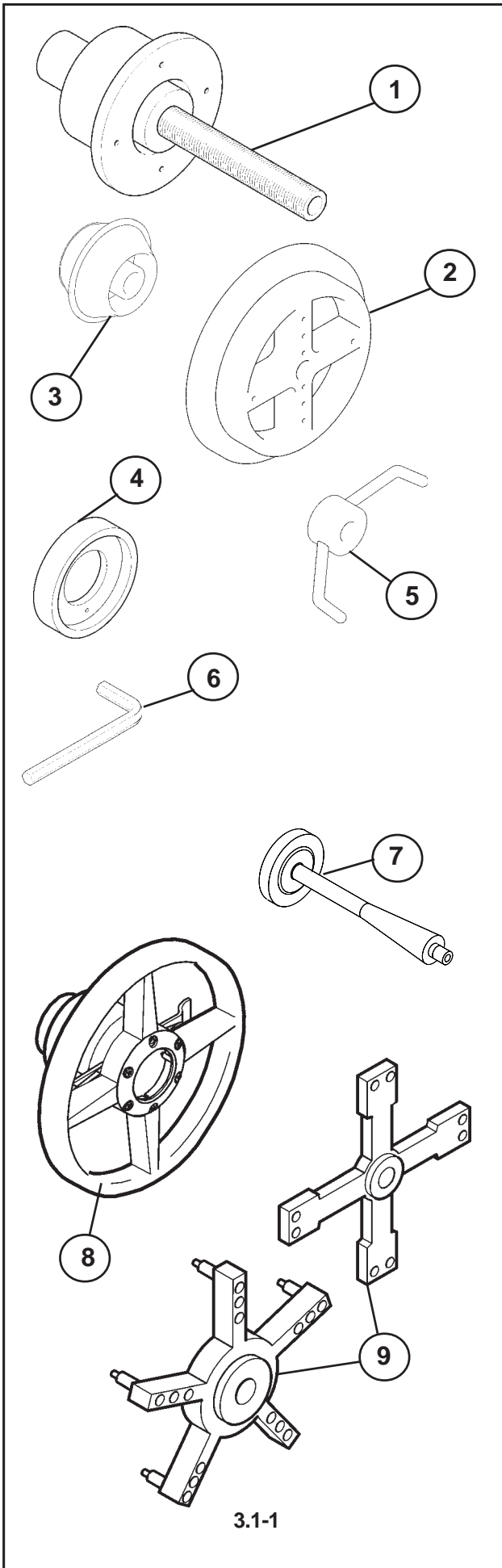



**Standard accessories for HNA**

Figure 3.2-1.

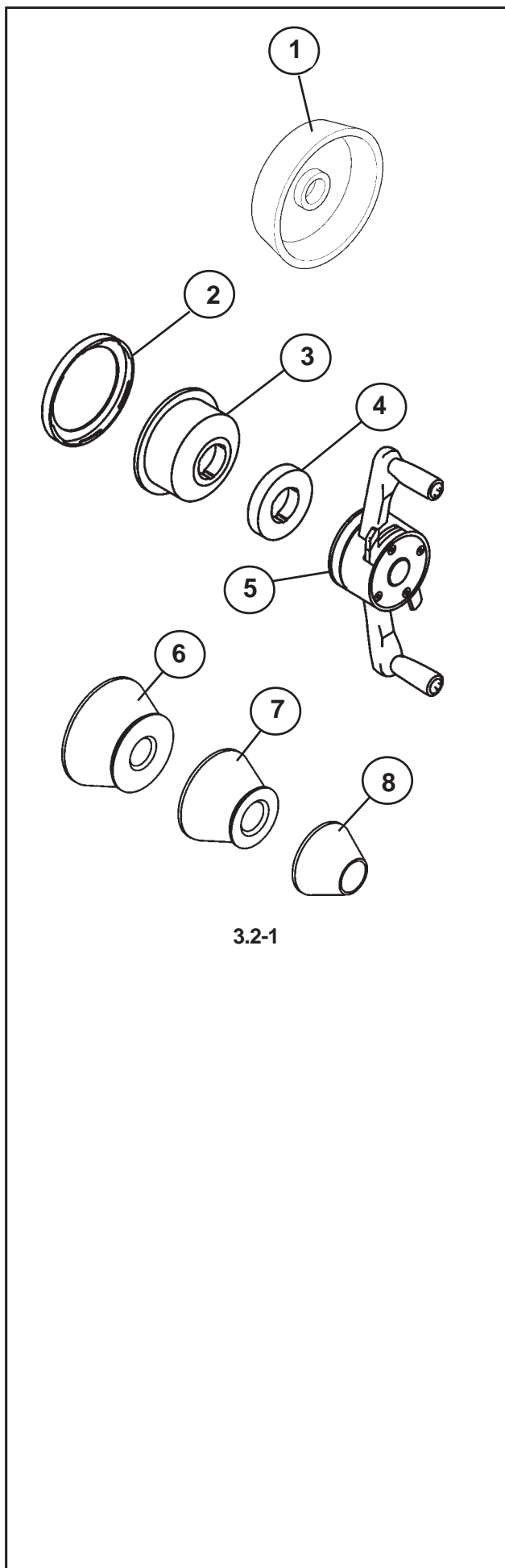

3.2-1

1	Cone 8' - 9"	641571711
2	Universal drum cushion	EAC0058D15A
3	Universal drum	EAC0058D07A
4	Spacer ring	EAC0058D08A
5	Quick-Release Hub Nut	EAA0263G66A
6	Large cone	EAM0005D25A
7	Medium cone	EAM0005D24A
8	Small cone	EAM0005D23A

## 4.0 Layout.

Refer to Figure 4-1.

Functional description of the unit:

1. **Display**  
Refer to Chapter 4.1.
2. **Input panel**  
Refer to Chapter 4.2.
3. **Internal gauge arm**
4. **Flange**
5. **Stub shaft with hub nut**
6. **Weight compartments**
7. **Storage areas for cones and hub nuts**
8. **Wheel guard**

Refer to Figure 4-2.

1. **Mains switch (ON/OFF)**

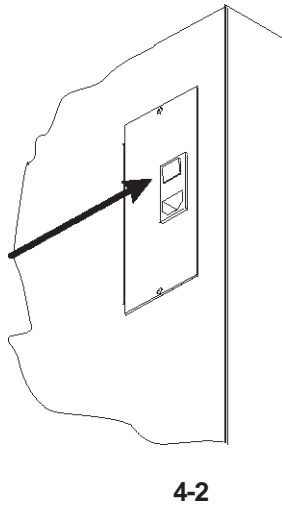
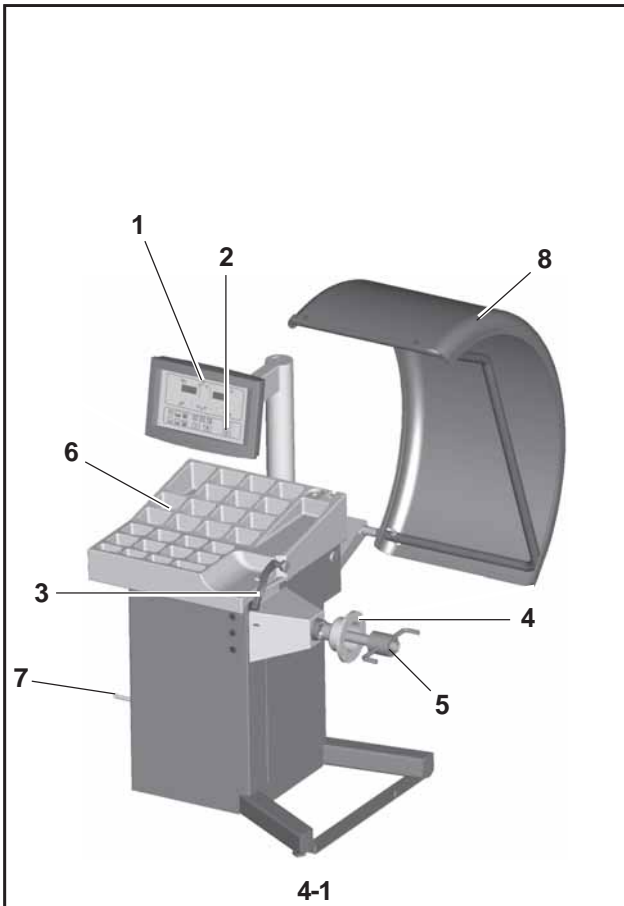

## 4.1 The display.

Refer to Figures 4.1-1, 4.1-2.

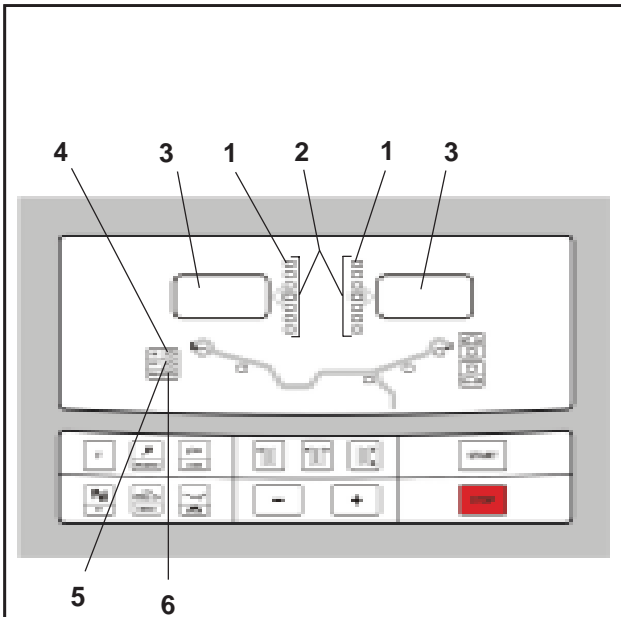

4.1-1

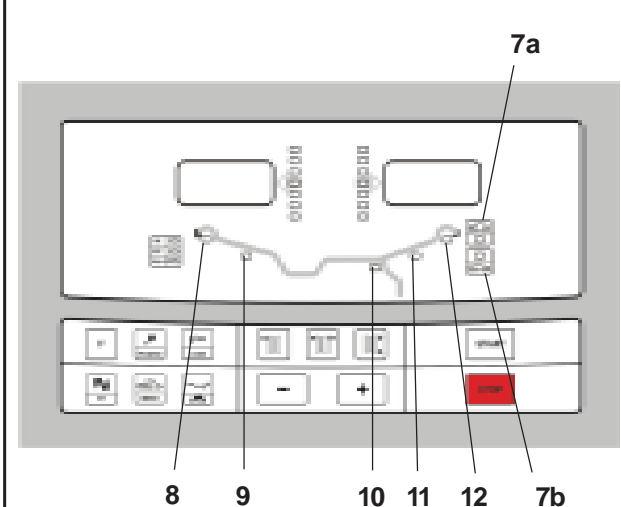

4.1-2

### 1. Rotation indicators of the correction plane.

The indicators show the direction the operator has to rotate the wheel (by hand) after a balancing run.

### 2. Weight Application Position Indicator.

The indicator will light up when the wheel is in the correct position for weight application. This indicator will be referred to as the WAP indicator.

Refer to the weight mode selected before applying a weight!

### 3. Display.

Depending on the stage of the program the display gives the operator information about rim sizes, balancing weights, error codes, etc.

### 4. Weight units indicator, "Oz".

The indicator will light if the weight is displayed in ounces (default) instead of grams.

### 5. INT function.

This indicator lights up when the "INTERNAL" balancing mode is selected.

### 6. Flange compensation.

This indicator lights up when flange compensation is activated

### 7. Truck, Light-Truck and Car Mode Indicator.

This indicator lights up as follows depending on which mode is active.

- **Truck Mode:** both LEDs are OFF .
- **Light-Truck Mode:** the 7a LED is ON.
- **Car Mode:** the 7b LED is ON.

### 8,12

#### Weight Position Indicator.

Apply a clip-on weight to the rim at the position indicated when the Weight Application Position Indicator for this plane lights up.

### 9,10,11

#### Weight Position Indicator.

Apply a stick-on weight to the rim at the position indicated when the Weight Application Position Indicator for this plane lights up.

## 4.2 The input panel

Refer to Figure 4.2-1.

### 1. Diameter key with indicator.

Press to select "rim diameter" mode, the current diameter or "dia" value will appear and the unit will beep.

The current value will be shown on the display and can be edited.

### 2. Width key with indicator.

Press to select "rim width" mode, the [|- - -|] symbol will appear, representing the width value and the unit will beep.

The current value will be shown on the display and can be edited.

### 3. Offset key with indicator.

Press to select "Offset" mode, the ---| or current offset value will appear and the unit will beep.

### 4. + key.

To increase an input value (e.g. rim diameter, offset, rim width).

Hold the key down to increase the values shown automatically.

### 5. - key.

To decrease an input value (e.g. rim diameter, offset, rim width).

Hold down the key to reduce the values shown automatically.

### 6. Function key.

Activates the second function of multi-function keys (indicated by the graphics on the lower section of the keys). Press this key and F appears on the left display then disappears when you press one of the function keys. The F on the display also disappears when you press the function key again (it is sometimes used like enter).

### 7. Fine key.

Press to toggle the read-out accuracy between Normal, or 25, 50 or 100 (0,5,1 or 2 oz) depending on the registered value and Fine i.e. 10 grams (0.5oz) regardless of the registered value. The unit will beep. Release the key to return to normal accuracy. F+Fine key activates the car wheel optimisation and minimisation operation. The unit will beep.

Release the key to return to normal accuracy.

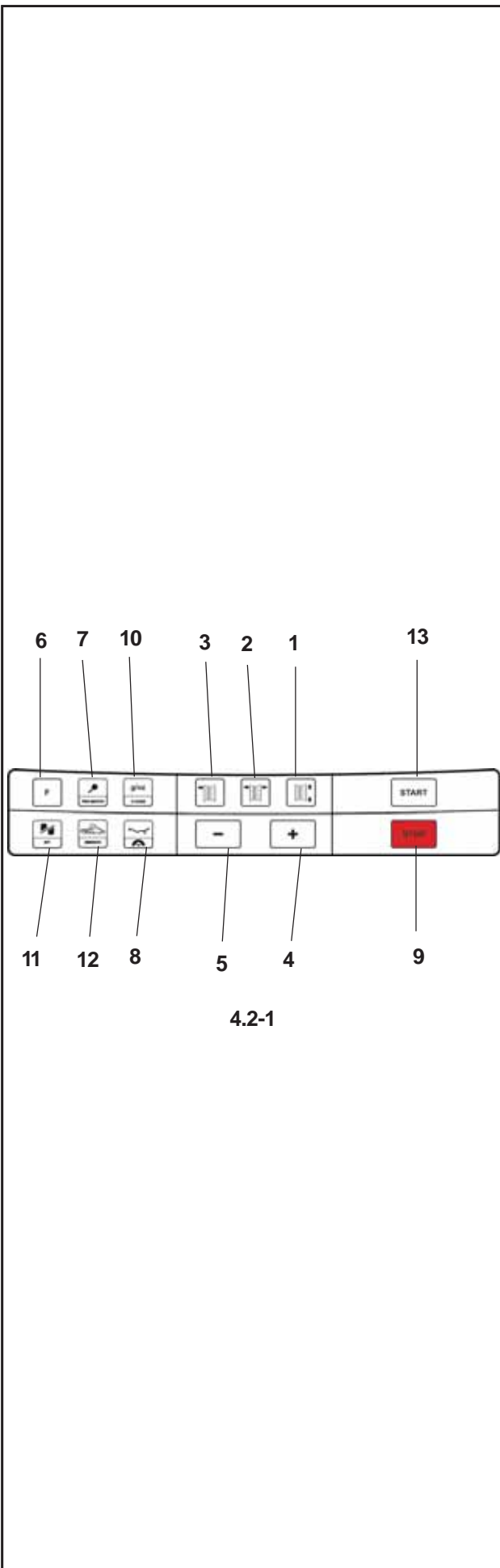

4.2-1

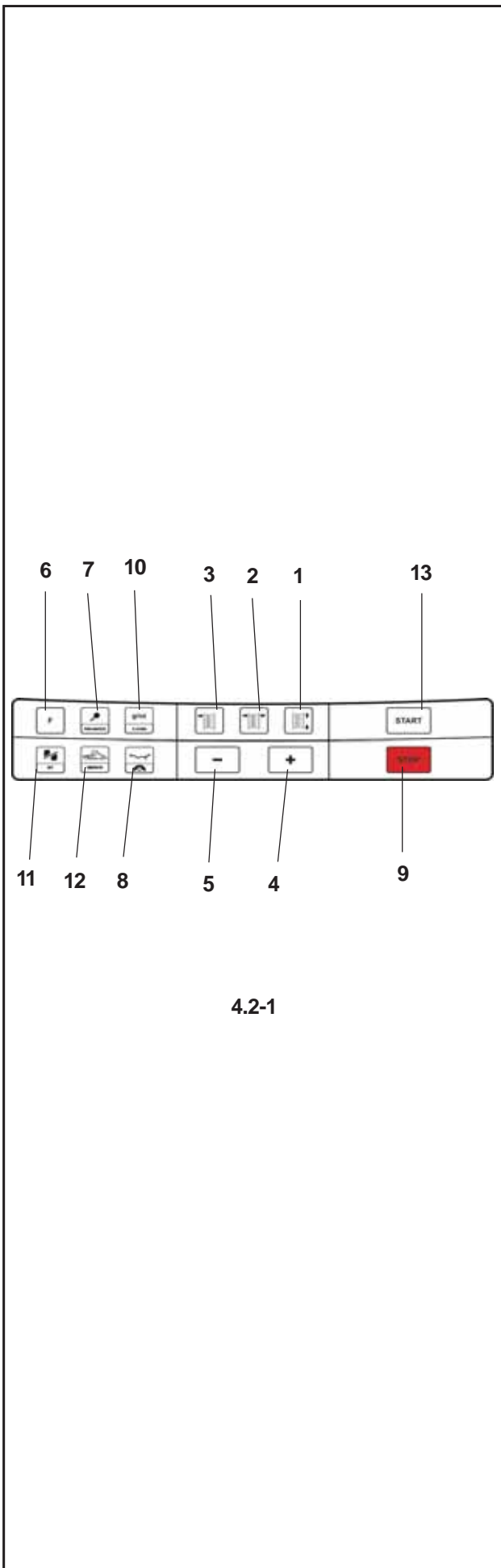

4.2-1

**8. Weight key.**

Press to select the required weight application mode (weight mode), the unit will beep.  
 F+Weight key; activates the SWM function, hidden weight split. This can only be activated after selecting the ALU2P/ALU3P application mode.

**9. Stop key.**

Press to stop spinning the wheel.  
 The STOP key also has an emergency stop function.

**10.g/oz key.**

Toggles between reading in grams and in ounces, and vice versa.  
 F+g/oz; activates the C-Code functions, special user functions.

**11. Static/Dynamic key.**

Toggles between dynamic and static modes.  
 F+Stat/Dyn; activates the function for balancing with a stick-on counterweight inside the tyre.  
 The INT LED on the panel lights up.

**12.Truck/Light-Truck/Car key.**

Toggles between the vehicle type setting: Truck, Light-truck or car  
 F+Vehicle; allows you to change the unit of measurement according to the size of the wheel.  
 Switches from millimetres to inches and vice versa.

**13.START key.**

Starts the machine spinning the wheel.

## 5.0 Operation

This chapter describes how to operate the unit in order to balance a wheel.

The standard balancing runs will be described first.

In chapter 5.4 and up special modes and functions will be described.

Be sure to be familiar with:

- possible dangers, refer to chapter 1
- the unit, refer to chapter 4.

## 5.1 Operation of the pneumatic loading device

The loading device is required by truck wheel legislation but it is not included with the unit.

Fig. 5.1-1 Control column and function of the pneumatic loading device

- 1 Switch lever for UP - DOWN travel
- 2 Air connection
- 3 Hook for storage of adaptors when not in use

- Lower loading device to bottom position.
- Roll wheel onto sliding carriage and lean it against the handle.
- Raise loading device to the required height.

- Position the wheel on the adaptor using the sliding carriage and clamp.
- Lower loading device until the wheel can rotate freely.

To remove a wheel proceed as follows:

- Remove the wing nut and then the cone or centering star.
- Remove the wheel using the loading device.

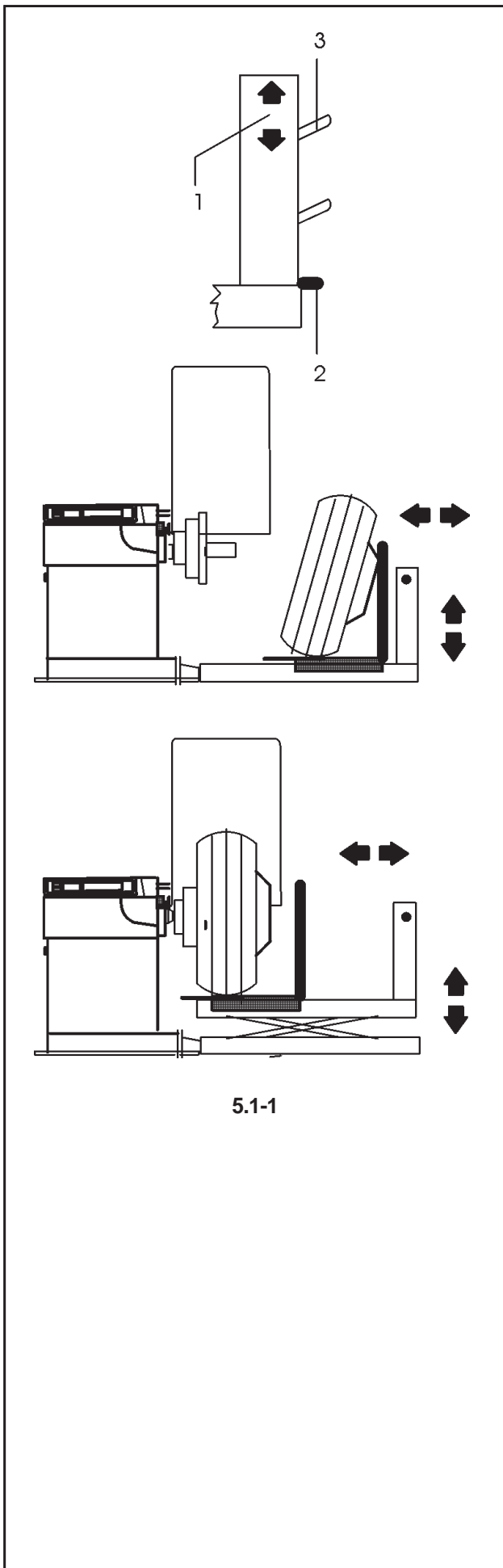

## 5.1.1 Clamping a truck wheel

The machine is delivered with an adaptors for light-truck wheels.

Clamping accessories for truck wheels are optional extras, but they are indispensable for balancing the following types of wheel:

**Fig. 5.1-2 Clamping a truck wheel using an adaptor and a centering cone**

- 1 Truck wheel flange
- 2 Rim
- 3 Centering cone
- 4 Clamp nut for clamping

**Fig. 5.1-3 Clamping a truck wheel using an adaptor and a centering star**

- 1 Truck wheel flange
- 2 Rim
- 3 Centering star
- 4 Clamp nut for clamping

### Note

To clamp a truck wheel with flange and centering star, the golden truck wheel flange has to be used.

### Clamping procedure

- Before clamping the wheel, check that the centre bore is machined sufficiently accurately and not deformed (e.g. uniformly round) and that the contact surface of the wheel (central rim disc) is clean and intact.
- Select and prepare a suitable clamping adaptor for the wheel to be balanced (Fig. 5.1-2 and 5.1-3).
- Position the wheel bore at the centre of the clamping adaptor (Fig. 5.1-1).
- Fit the cone or centering star and partly tighten the wheel with the wing nut.
- Lower the loading device until the wheel can rotate freely.
- As the wheel is further clamped continue rotating the wheel slightly and further tighten the wing nut. In this way the wheel will be aligned evenly with the centering cone or centering star and will run smoothly when clamped.

### Note

For best balancing results the adaptors must always be kept clean and stored correctly when not in use.

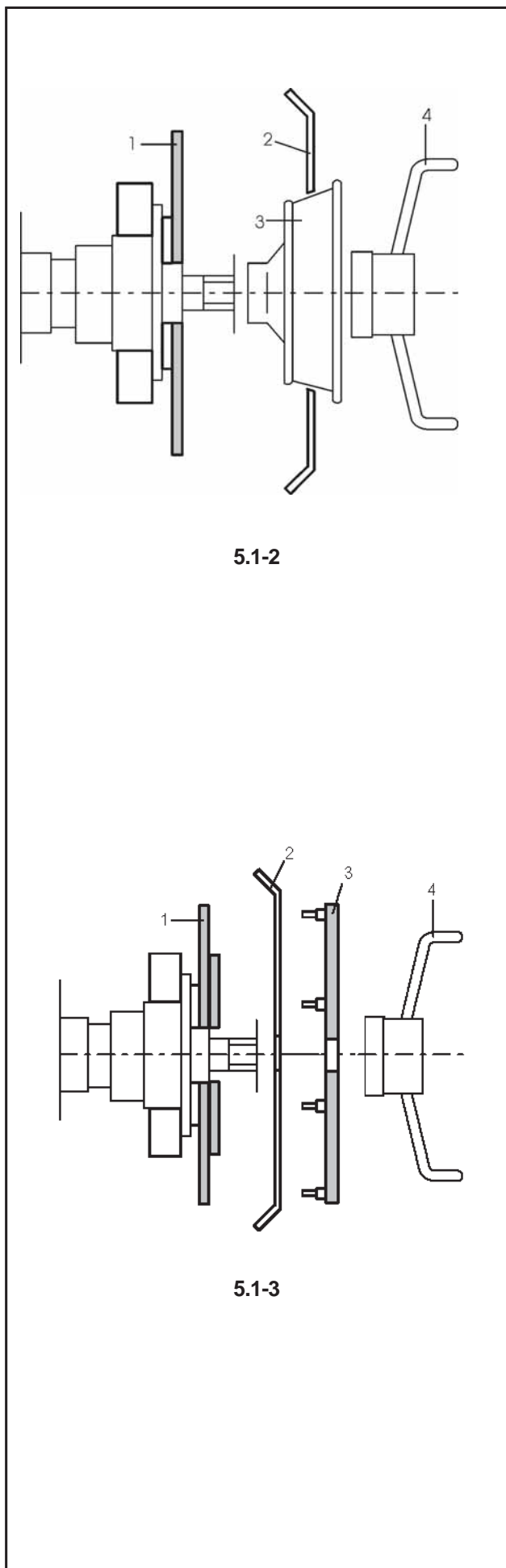

## 5.1.2 Clamping a car wheel

Fig. 5.1-4 illustrates clamping a conventional car wheel using a clamping adaptor on the central bore.

Fig. 5.1-5 illustrates clamping a stud hole located car wheel or a car wheel without centre bore using a universal clamping adaptor.

The centering cones for clamping car wheels are not part of the standard equipment. These cones as well as various special clamping and centering means are available on request.

The range and applications of the clamping means are described in separate leaflets.

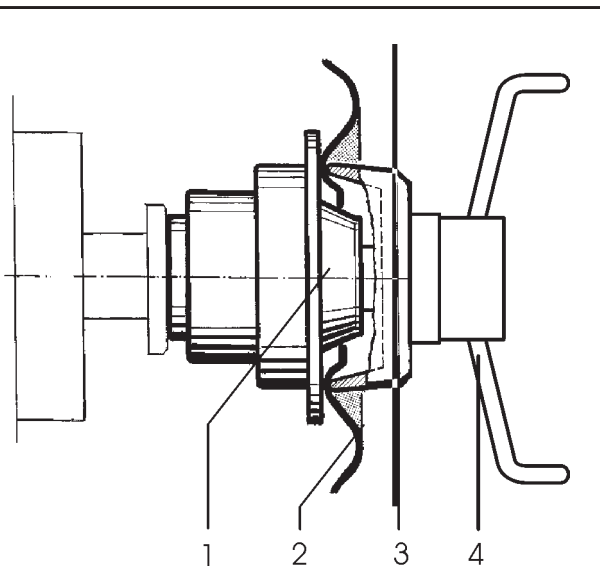

5.1-4

Fig. 5.1-4 Clamping adaptor to clamp center bore located car wheels

- 1 Cone for car wheels
- 2 Rim
- 3 Clamping head with clamping nut (quick-clamping nut)
- 4 Wing nut for clamping

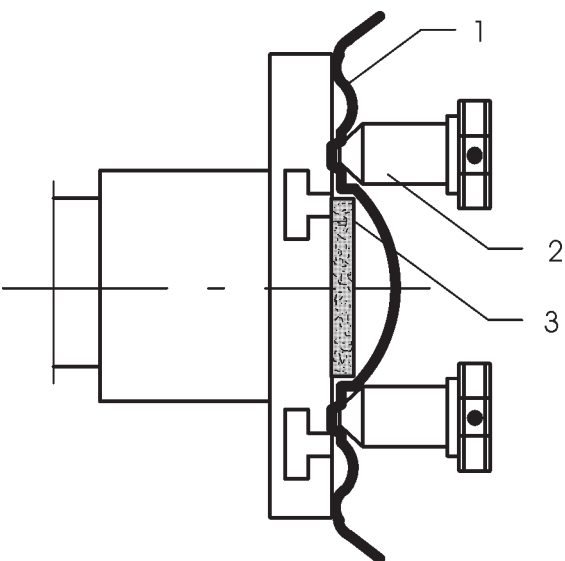

5.1-5

Fig. 5.1-5 Universal clamping adaptor for clamping stud hole located wheels or wheels with closed rim. This clamping adaptor is also capable of clamping center bore located wheels when suitable centering rings are used.

- 1 Rim
- 2 Quick-clamping nut
- 3 Centering ring for center bore located car wheels (optional extra)



## 5.2 Preparation

- The operator should be familiar with the warnings and cautions.
- The operator should be qualified to work with the unit.
- Always ensure that the wheel guard (when applicable) is lifted and the gauge arm is in its home position (far left position) when the unit has been switched off.

### 5.2.1 Power up

- Do not keep any key pressed down during power up.

Refer to Figure 5.2.1-1.

- Insert the power cable plug in the mains socket.
- Set the switch on the socket to the “I” position.

Note: If the unit beeps and does not proceed or if an error code is shown, refer to Chapter 7.

The unit will beep and perform a self-test now.

The display and the weight position indicators relating to the current weight mode will stay on (default).

Refer to Figure 5.2.1-2 for an example.

The unit is now ready to receive input.

### 5.2.2 Emergency stop

Refer to Figure 5.2.2-1.

To perform an emergency stop:

- **Select the STOP key to apply the electronic brake.**

In the event of an emergency stop due to an unexpected action by the unit, rethink the steps that were made:

**Did the operator make an error or omit to do something?**

Correct the input and continue working. No special procedure is required.

**Did the unit do something unexpected?**

- Read the relevant chapters again.
- Prepare the unit for a restart:
  - switch off the unit
  - switch on the unit again.
- Carefully repeat the commands with the manual available.
- If the unit does not function correctly, call the service team immediately and:

**WARNING: PREVENT ANY FURTHER USE OF THE UNIT.**

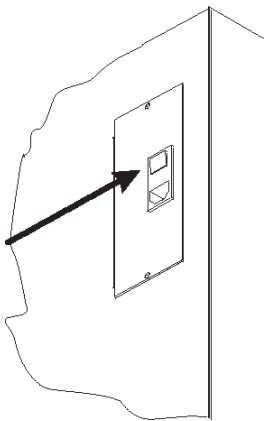

5.2.1-1

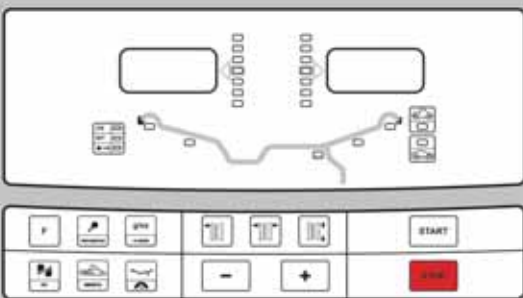

5.2.1-2

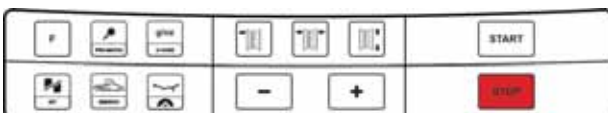

5.2.2-1

## 5.2.3 Shutting down

Always shut down properly when work is complete:

- Remove the wheel from the balancer.
- Remove the cones and hub nut from the shaft. Check the surfaces (internal and external) of the cones for damage. The condition of the cone is very important for a good balance quality.
- Check the thread of the hub nut and shaft.
- Clean all threads and surfaces with a dry, soft cloth.
- Store the cones and the hub nut in the correct place.
- Unplug the mains cable from the power outlet.
- Check the power cable for damage or wear.
- Tidy up the storage areas.
- Clean the display and input panel with a soft, dry cloth.
- Remove old wheel weights and other material from under the balancer. The balancer must rest on its three feet only.

## 5.2.4 Settings

After switching on the unit, a default weight mode is shown. If the unit then shows another weight mode, refer to Chapter 5.3.2.

The unit of measurement indicated at power up is inches, but the setting selected before switching off for grams / ounces remains.

### 5.2.4.1 Changing the Weight Unit

Default weight unit setting: Ounces

Proceed as follows to change the weight unit, whether you have already spun the wheel or not.

- Press and hold down the "F" key and then press "-Gr/Oz".

Repeat the procedure to turn the display back to grams.

### 5.2.4.2 Changing the Dimensions Unit

Default diameter and width unit setting: inches.

- Press and hold down the "F" key and then press "-mm-inch".

Repeat the procedure to turn the display back to inches.

## 5.3.2 Balancing

This chapter describes how to balance a wheel.

For help on:

- rim data input refer to Chapter 5.3.1
- spinning the wheel refer to Chapter 5.3.3
- weight application refer to Chapter 5.3.4
- the check spin refer to Chapter 5.3.5

### 5.3.2.1 Normal weight mode

(Available in TRUCK and CAR/LIGHT-TRUCK modes)

When selected, the display is as shown in Figure 5.3.2.1-1.

Figure 5.3.2.1-2 shows the rim reference point.

- Establish the following dimensions:
  - Rim diameter of the reference point.
  - Rim width.
  - Offset of the reference point.
- After entering the dimensions, spin the wheel.
- Apply the **clip-on** weights at the indicated positions, at the 12 o'clock position.
- Perform a check spin when done.

### 5.3.2.2 ALU weight modes

Select an ALU weight mode if one or more stick-on weights will be used.

ATTENTION: IN TRUCK MODE ONLY THE NORMAL, ALU1 AND ALU2P MODES ARE AVAILABLE.

When selected, the display shows:

ALU1: Refer to Figure 5.3.2.2-1.

ALU2: Refer to Figure 5.3.2.2-2.

ALU3: Refer to Figure 5.3.2.2-3.

ALU4: Refer to Figure 5.3.2.2-4.

ALU5: Refer to Figure 5.3.2.2-5.

- Establish the following dimensions:
  - Rim diameter of the reference point.
  - Rim width.
  - Offset of the reference point.

Note: For ALU2 and ALU3 the right hand plane is equal to the front surface of the flange. The weight should be applied in that plane. Deviations in that plane should be compensated by increasing or reducing the weight applied. Refer to Figure 5.3.2.2-6.

- After entering the dimensions, spin the wheel.
- Apply the **clip-on/stick-on weights** at the indicated 12 o'clock positions.
- Perform a check spin when done.

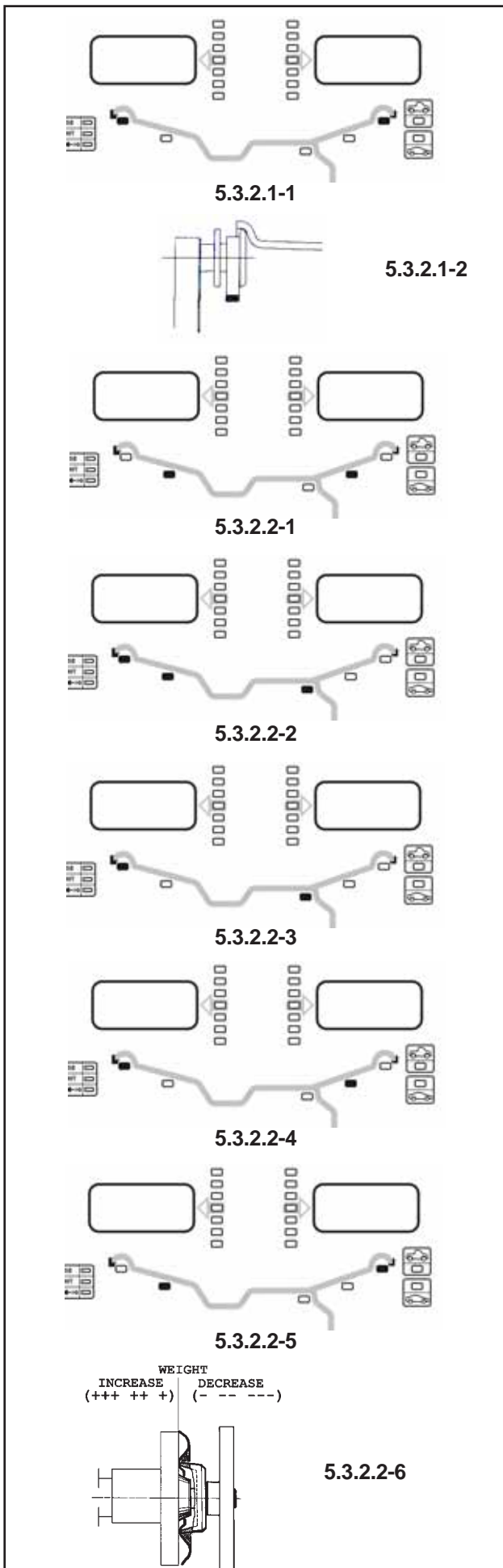

### 5.3.2.3 Alu2P and Alu3P (HWM) mode

Select this mode for more exact balancing, weight positioning behind spokes or special rims (PAX, TRX, CTS, etc.).

When selected, the display shows:

HWM1: Refer to Figure 5.3.2.3-1.

Two stick-on weights.

HWM2: Refer to Figure 5.3.2.3-2.

Left plane: clip-on weight

Right plane: stick-on weight.

Note: The relevant HWM indicator is lit.

Figure 5.3.2.3-3 (1) and (2) shows the rim reference points.

- Use the gauge arm to enter the two rim reference points.  
The distance between the left plane and right plane offset points must be 77 mm (3") minimum.  
Note: To balance a PAX wheel (HWM1 only):
- Select mm mode (Chapter 5.2.4.2).
- The rim diameter can only be changed to the predefined values. Enter dimensions.
- After entering the dimensions, spin the wheel.

Always apply the **stick-on weights** with the gauge arm at the positions indicated. Check the correct weight application distance when the display shows the value "0" and the machine beeps.

Note: If the arm is extracted with the wheel incorrectly positioned, warning H21 appears on the display, see Chapter 7.

- Apply the weight in the left plane.  
**Note:** If the weight is to be split and put exactly behind two spokes, select SWM now. Refer to Chapter 5.12.
- Apply the weight in the right plane.
- Perform a check spin.

### 5.3.2.4 Static balancing

Only static imbalance is measured and corrected.

When selected, the display is as shown in Figure 5.3.2.4-1.

Figure 5.3.2.4-2 shows the recommended rim reference point.

- Establish the following dimensions:
  - Rim diameter of the reference point.
  - Width. If the rim width is  $\leq 3"$ , enter 3".
  - Offset of the reference point.
- After entering the dimensions, spin the wheel.
- Apply the **stick-on** or **clip-on** weight at the 12 o'clock position.
- Perform a check spin when done.

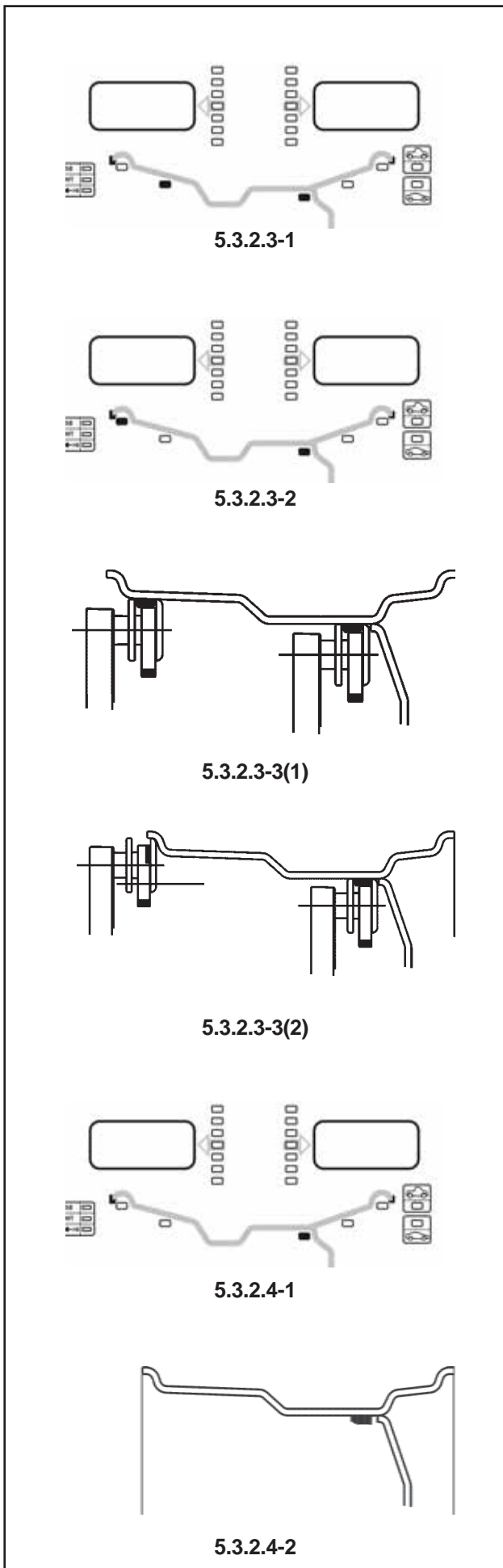

### 5.3.2.5 Internal Balancing

Application of a patch inside a tyre.

To activate the procedure press key "F" (1) then the "INT" (2) key, Figure 5.3.2.5-1. The left-hand display shows the text "d IA", which means you must enter the external tyre diameter which will be shown on the right-hand display.

Note: The procedure is the same as for static balancing; the only difference being that you need to enter the external tyre diameter in order to calculate the weight.

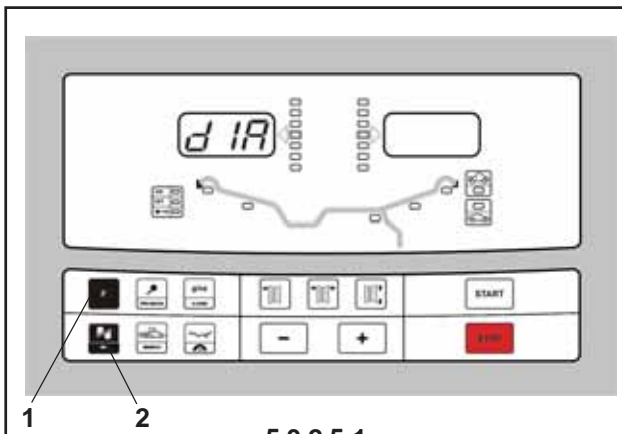

5.3.2.5-1

### 5.3.3 Spinning the Wheel

The wheel data must be acquired and the type of rim to be used must be entered.

- Lower the Wheel Guard to its horizontal position.
- Press "START" to spin the wheel, Figure 5.3.3-1.

The motor starts up and the wheel spins.

Wheels must turn towards the right, seen from the side of the unit on which they are mounted.

The measurement is completed as soon as the direction indicators light up. The unit beeps. The brake will be applied automatically and the wheel will stop in the correct left plane weight application position.

The weight(s) to be applied will be shown on the display. For higher precision, select Fine.

- Lift the wheel guard to its vertical position.

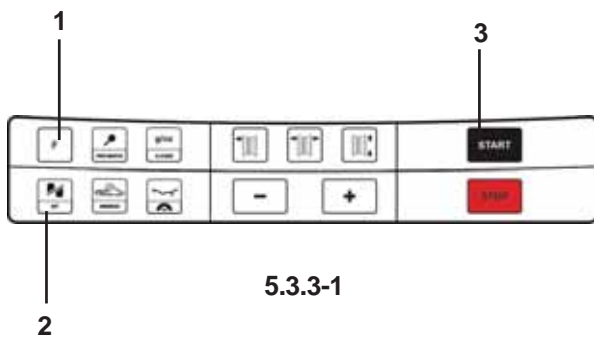

5.3.3-1

## 5.3.4 Weight application

The following weight types and application methods are available:

- clip-on weights.  
Always apply by hand.
  - stick-on weights.  
Must be applied by hand or with the gauge arm, depending on the weight mode.
- Note: Hand applied weights must always be applied exactly perpendicular to the shaft (12 o'clock position).

After spinning the wheel (refer to Figure 5.3.4-1):

- Look at the rotation indicators for the left plane of the wheel.

If one or more indicators are lit:

- Turn the wheel to find the application point.

As the correct angular position of the wheel is approached the indicator will light. When all indicators are lit, the position is correct, Figure 5.3.4-2.

- Note: At the correct angular position all rotation indicators will be lit. If the wheel has been rotated too far, only the indicators for the other half will be lit. Refer to Figure 5.3.4-3. The wheel has to be gently reversed.

The weight to be applied in that plane is shown on the display:

In Truck and Light-truck modes an electromechanical brake stops the wheel turning.

- Press the STOP key to release the brake.
- Turn the wheel manually until it reaches the counterweight application point

### Attaching a clip-on weight.

Refer to Figure 5.3.4-4.

- Clip-on weights must always be applied in the 12 o'clock position.
- The lip should rest on the rim edge. Use the weight pliers to position it.

In STATIC mode only the left hand display is used.

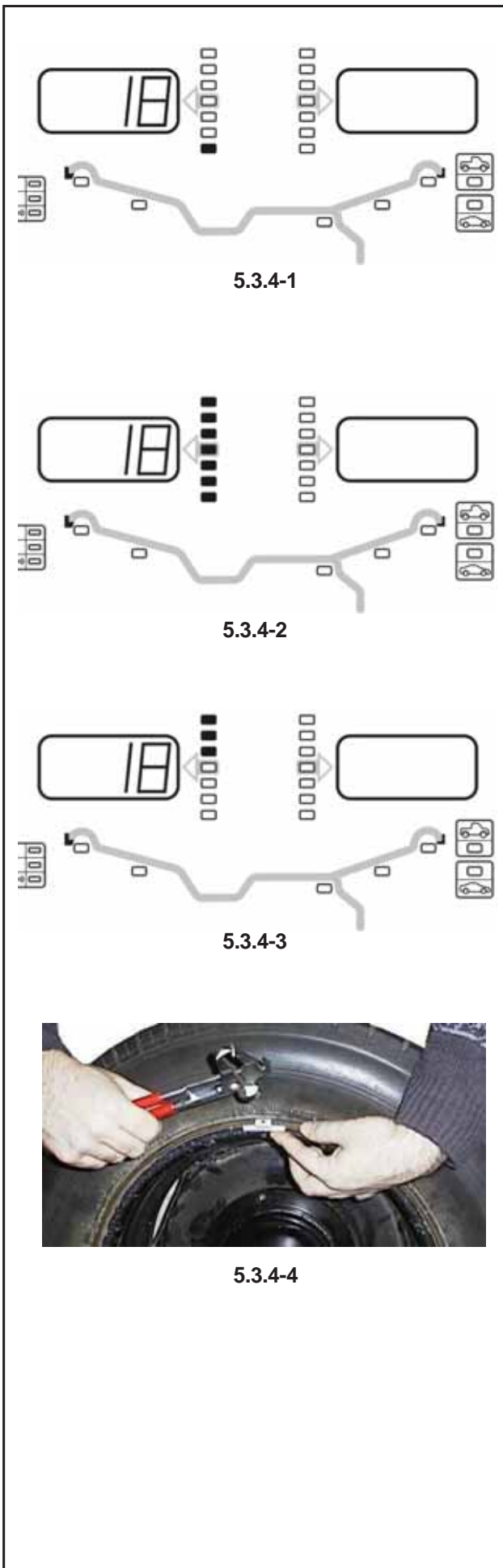

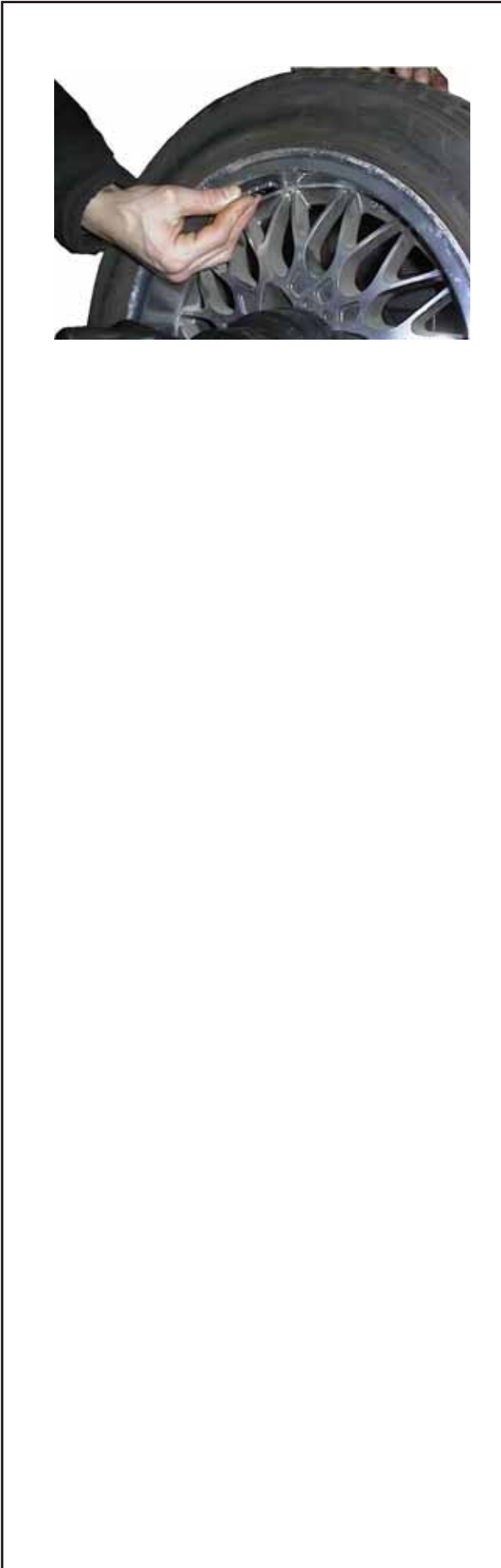

**Attaching a stick-on weight.**

**ALU or STATIC weight modes only:**

Refer to Figure 5.3.4-5.

- Apply the weight on the rim in the 12 o'clock position at the correct offset position.
- The lit indicator on the display gives an indication of the correct position.

**Note:** With STATIC weight modes, always apply the weight at the rim centre line. If not possible, split the weights evenly and apply on another surface of the rim (symmetrical to the rim centre line).

**Alu 2P and Alu 3P (HWM) weight modes:**

Refer to Figure 5.3.4-6.

The gauge arm must be used to apply the stick-on weight(s).

- Place the stick-on weight on the gauge arm. Refer to Figure 5.3.4-7.
- Bring the gauge arm to the left plane reference point.

**Note:** When the value "0" appears while moving the arm, the machine beeps to indicate that the correct application position has been reached.

- Apply the weight to the correct point on the rim.
- Decide to use Weight Mode now (Chapter 5.4.1).
- Rotate the wheel to the next Weight Application Indicator position, put the stick-on weight on the gauge arm and apply the weight at the right plane reference point.

**Note:** When the internal gauge is removed, the data is normally displayed, unless the left plane has reached the angular position for weight application and a stick-on weight is used.

Or

The right plane has not reached the angular position for weight application.

When this happens, the appropriate weight and a variable number appear on the other display to indicate the direction in which the gauge arm must be moved in order to find the correct weight application position.

### 5.3.5 Check spin

It is good practice to perform a check spin after applying the weights.

- Spin the wheel.

If the wheel has been balanced properly, "000" will be displayed for both planes. To check how much imbalance is left:

- Select the fine key.
- Rotate the wheel by hand.

The weight to be applied is shown on the display.

**Note:** The operator should decide if applying the stated weight is necessary.

### 5.3.6 Results recalculation

After spinning a wheel it is possible to enter new rim data or select another weight mode. The results are recalculated automatically, if possible.

**Editing rim data:**

- non-HWM: automatic recalculation
- HWM: both plane reference points should be entered again.

**Selecting another weight mode**

- Between NORMAL, ALU and STATIC: no additional steps required.
- From non-HWM to HWM: input of plane reference points is required.

**Note:** The minimum HWM diameter differs from the non-HWM types.

- From HWM to non-HWM: check diameter, offset and width.

**Note:** These dimensions relate to the latest input done in NORMAL, ALU or STATIC mode.

- From HWM1 to HWM2: no additional steps required.
- From HWM2 to HWM1: input of plane reference points required.
- Select "**fine**" Figure 5.3.6-1 to toggle between Weight Application Mode and Data Entry Mode.
- State the new plane reference points.
- Apply the weight(s).

To have a recalculation done:

- Select the required weight mode. Check and/or edit rim or plane data when necessary.
- Rotate the wheel to the left plane Weight Application Position Indicator and apply the weight.
- Rotate the wheel to the right plane Weight Application Position Indicator and apply the weight.
- Perform a check spin

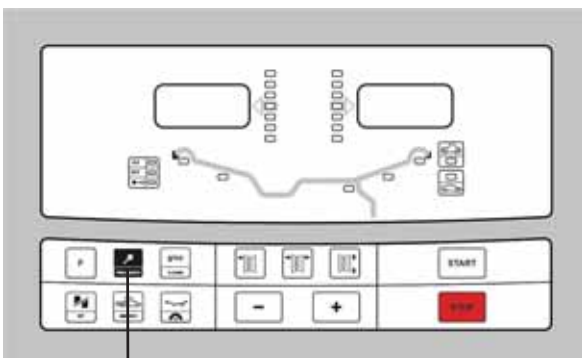

1

5.3.6-1



## 5.3 Balancing procedure

The unit always has a weight mode automatically selected, refer to the display. Select the appropriate key (refer to Figure 5.3-1) to scroll through the weight modes continuously. The weight mode currently selected is shown by the illuminated indicator(s).

### NORMAL

Used for steel rims.

### ALU mode

Used for light alloy rims or where one or more stick-on weights are to be used.

The stick-on weight(s) must be applied by hand.

### Hidden Weight Mode

Used for light alloy rims or for wheels that are difficult to balance.

The stick-on weight(s) must be applied with the gauge arm. This guarantees more accurate weight positioning compared to applying the stick-on weight(s) by hand.

**Note:** If the stick-on weight must be hidden behind two spokes, select the Split Weight Mode before applying the weight in the right plane. Refer to Chapter 5.4.1.

### STATIC

Retrieve the function with key 12 fig. 5.3-2. Two LEDs light up and flash.

Used for small wheels that are not balanced dynamically, e.g.: small moped wheels.

No "left" or "right" weight is calculated.

Mount the wheel according to Chapter 5.1 and select the correct weight mode.

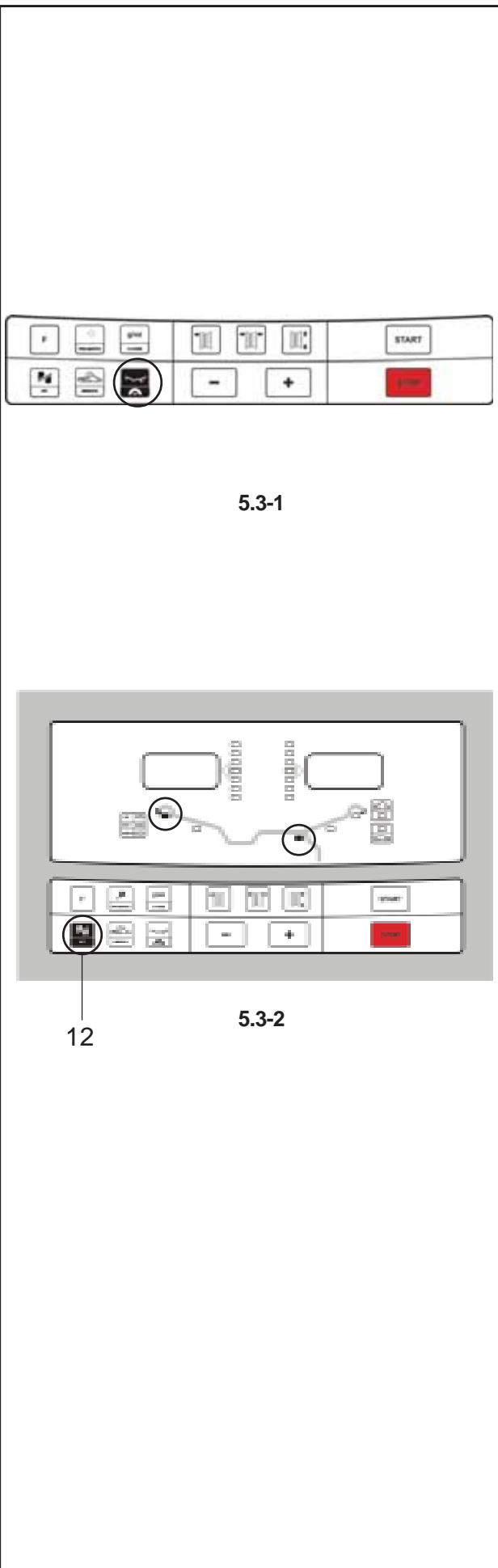

5.3-1

5.3-2

12

## 5.3.1 Rim data input

Dimensions can be entered either automatically using the gauge arm or measured by hand and then typed in on the keyboard.

### Dimension Units

diameter: inches (default) or mm.

rim width: inches (default) or mm.

offset: millimetres.

To change the units, refer to Chapter 5.2.4.2.

### Automatic data entry by using the GAUGE ARM

#### Non HWM mode:

- Rim diameter
  - Ensure that the gauge arm is in the home position.
  - To position the arm correctly on the rim, pull the gauge head holding ring inwards and hold it there until it has taken the measurement (1-Fig. 5.3.1-3)
  - Position the gauge arms correctly on the rim, so that the reference point on the arm is in contact with the reference point on the rim (2-Fig. 5.3.1-3)
  - Hold the gauge arm steady for at least one second. The machine will beep to indicate that the measurement has been taken and is within the program's parameter range.
- Rim width
  - Measure the rim manually with the callipers (refer to Fig. 5.3.1-1) or read the measurement directly on the rim itself if it's written there.
  - Press the "Rim width" key.
  - Enter the value manually using the keyboard.

**Note:** when the Automatic Measurer has registered the Diameter and Offset, the machine is immediately ready for the Wheel Width measurement to be entered.

- Offset
 

Offset equals the distance from the unit zero point to the rim reference or weight fixing plane reference point. Refer to Figure 5.3.1-2.

The rim or plane reference point **depends on the type of wheel**, refer to Chapter 5.3.2.

These measurements are always taken at the same time as that of the diameter. If you need to repeat the operation.

Proceed as described above for the rim diameter.

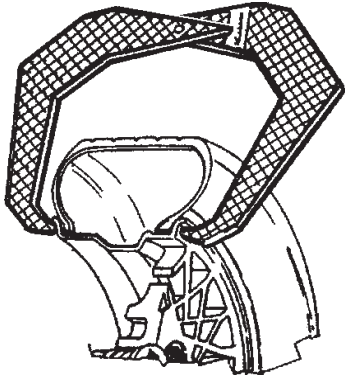

5.3.1-1

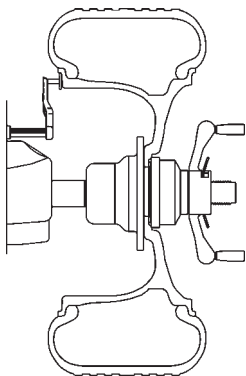

5.3.1-2

## Operation

At this point the LEDs on the control panel show again the weight application method selected and the width and diameter measurements appear on the display.

If a measurement operation has already been performed you can recalculate the measurements according to the new wheel data by activating a machine function, for example, by changing the weight allocation method or the imbalance precision display (Fine key) etc

### HWM mode

HWM mode data entry is as described above apart from after a diameter or offset has been measured by the gauge arm and the machine indicates exactly where the counterweights should be placed.

### MANUAL data entry

Manual data entry is required only if the gauge arm malfunctions. In that case proceed as follows:

- Rim or tyre diameter
  - Read the nominal rim diameter directly on the rim or tyre itself.
  - Select the diameter key on the control panel. The last value entered appears.
  - Enter the value read previously using the appropriate keys (refer to Chapter 4.2).
  - Select another measurement to edit (if necessary) or spin the wheel.

**Note:** the **MANUAL data entry** is also used for the "Tyre diameter" measurement requested for certain special Internal Balancing operations (Chapter 5.3.2.5).

- Rim width
  - Proceed as described above for the Automatic Data Entry operation.
- Offset:
  - Position the gauge arm correctly as described above in the "Rim Diameter" phase of the Automatic Data Entry operation
  - Read the arm extraction value on the gauged column.
  - Enter the value read previously using the appropriate keys.

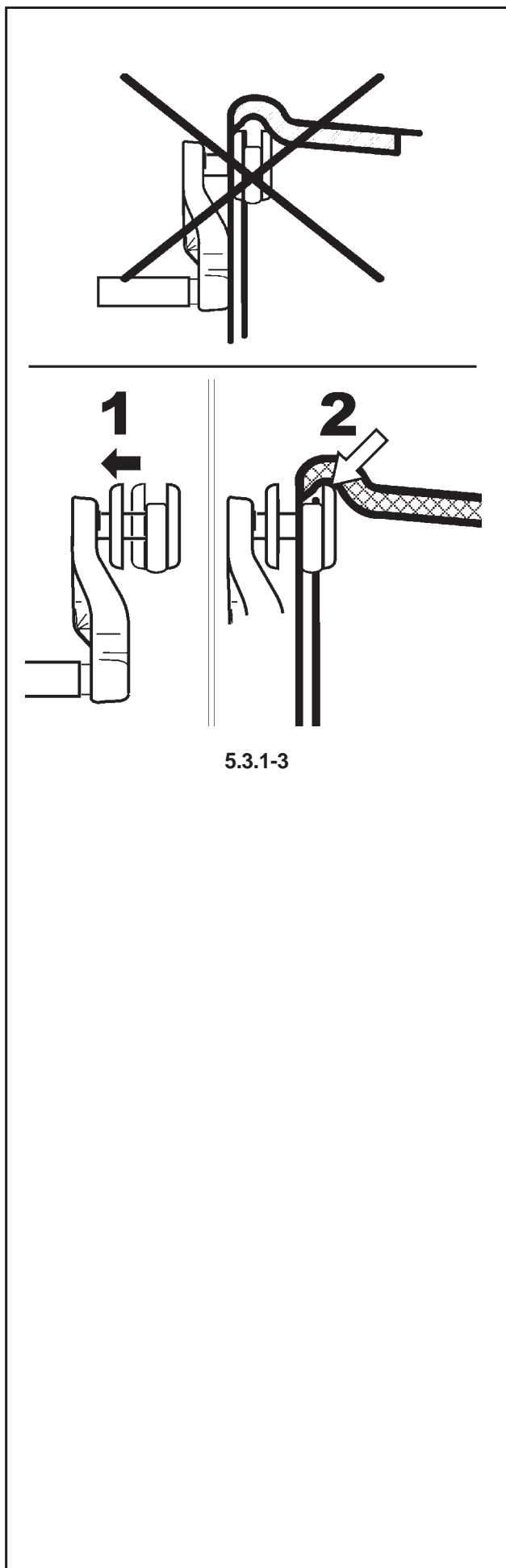

## 5.4 Special modes

Selecting the **F** key enables the operator to scroll the following modes in sequence:

- Split Weight Mode (SWM),
- Minimisation mode.

### 5.4.1 Split Weight Mode

Selecting is possible only after balancing a HWM wheel that has an imbalance  $\geq 10$  gram in the right plane.

**Note:** The “fine” read-out accuracy is not available with this mode.

Select this mode to “hide” the right plane weights split into two parts behind the two spokes that are nearest to the calculated weight application position. That way, the weights are not visible from “outside”.

Take into account the following limitations (refer to Figure 5.4.1-1):

- The whole enclosed angle is limited to  $120^\circ$ .
- both angles (from “visible weight position” and “hidden weight position”) must be greater than  $0^\circ$ .
- Apply the weight in the left plane of an HWM wheel.
- Don't apply the weight on the right plane but in the recommended application point press **F** (1)+ **Spoke** (2) figure 5.4.1-2. S1 appears.
- Turn the wheel until one of the spokes is in the 12 o'clock position, near the application position.
- Press **F** (1 Fig. 5.4.1-2). S2 appears.
- Turn the wheel until the adjoining spoke is in the 12 o'clock position.
- Press **F** (1 Fig. 5.4.1-2). The weight is now split.

The machine can now indicate the two weights and the relative application points.

### 5.4.2 Balancing optimization / Weight minimization

**Note:** even if the optimisation procedure can be carried out on truck wheels, it is mainly used for car wheels.

#### General

Optimisation is a refined form of matching. For optimisation the tire is mounted relative to the rim in a position selected according to the results of various measurements. This normally further reduces any radial and axial run-out as well as lateral and radial forces, making the wheel run as silently as possible. In addition,

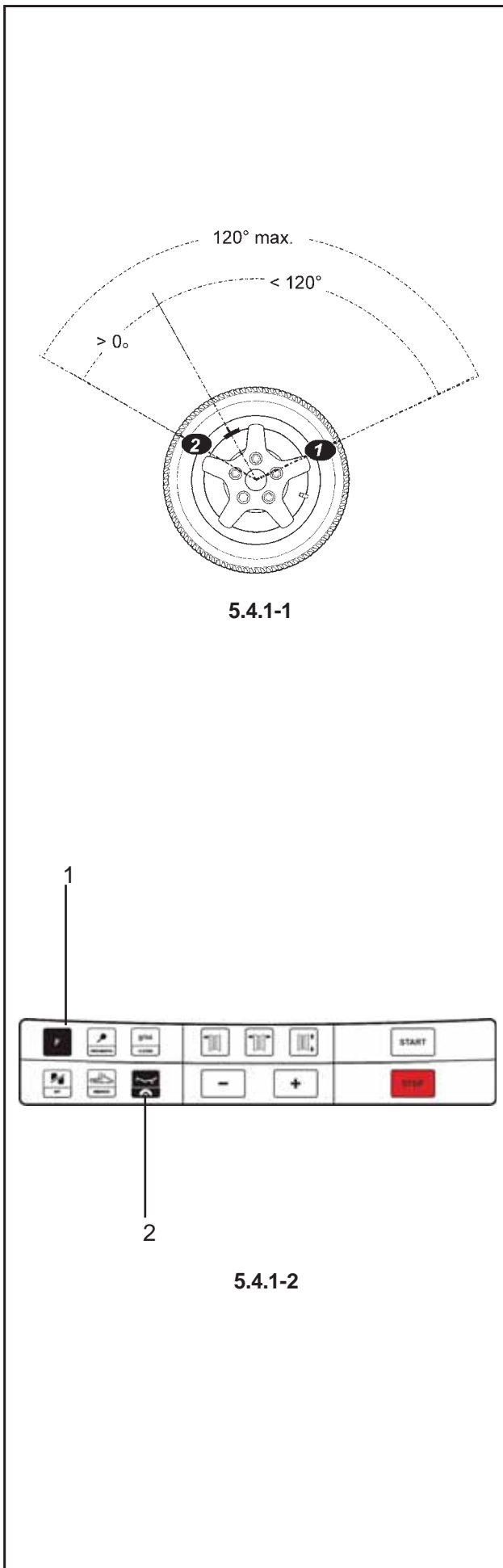

5.4.1-1

5.4.1-2

## Operation

the correction weights needed for balancing can also be reduced.

If optimisation is not required, weight minimisation (also known as matching) is possible.

For example, when the rim has no shape defects, meaning that wheel imbalance depends exclusively on tire irregularities. In such cases, the rim imbalance may be positioned relative to the tire imbalance so that they compensate one another and the machine calculates a minimum correction weight.

### Instructions for balancing optimisation / weight minimisation

During tire changing operations required for balancing optimisation / weight minimisation, the wheel balancer can be used as a conventional wheel balancer by another operator.

For this purpose, interrupt the optimisation / minimisation program by pressing the STOP key (4). The electronic unit will store the current program step, the rim dimensions and all measurements taken so far.

To continue with the optimisation / minimisation program, press the F key (1) in succession. The program then continues from the step where it was interrupted, with the relative measurement values and the balancing optimisation / weight minimisation may continue.

If a measuring run is interrupted by operation of the STOP key (e.g.: to clamp the wheel better or due to an emergency), the machine returns to the previous program step. Reset the valve position and continue balancing optimisation / weight minimisation.

After interruption by operation of the STOP key the readings refer to the imbalance of the latest measuring run.

To restart balancing optimisation / weight minimisation after an interruption, simply press the PRO-MATCH key (2).

During balancing optimisation / weight minimisation a measuring run always has to be started with the **START** key (3). The "Start measuring run by closing wheel guard" operating mode is not operative in this case.

Wheel clamping means compensation is cancelled by starting the balancing optimisation / weight minimisation cycle.

### Balancing optimisation program cycle

The following is a description of the balancing optimisation program cycle (code OP) and weight minimisation (code UN).

### Balancing optimisation

If after the measuring run the imbalance in the left or right correction plane and/or the static imbalance is more than 30 grams, perform automatic optimisation by activating the **F+PRO-MATCH** symbol.

- Before optimisation check that the rim dimensions have been set correctly.

You cannot correct the data later.

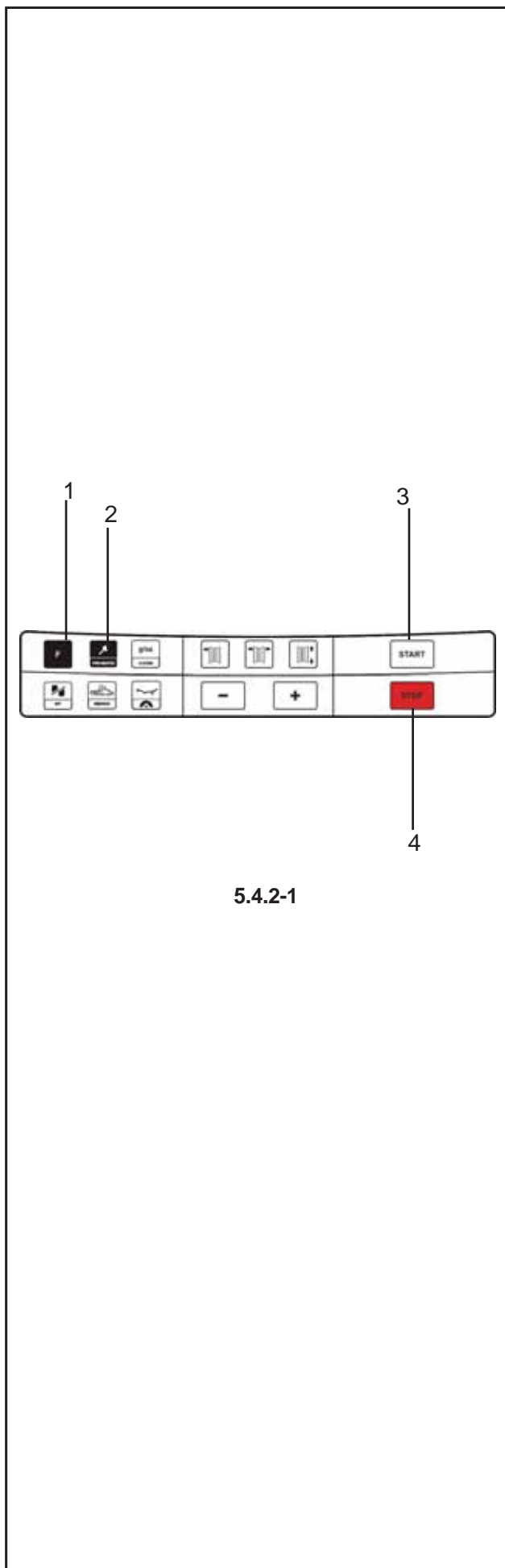

5.4.2-1

## Operation

- Demount the tire and clamp only the rim for the compensation run.

- Press the **PRO-MATCH** key (2).

The OP.1 reading appears.

In all figures in which the valve symbol appears on the edge of the rim, shift the tire on the rim then press the PRO-MATCH key (2) to set the valve position (exactly perpendicular to and above the main shaft).

- Readjust the rim so that the valve is exactly perpendicular to and above the main shaft.
- Press the **PRO-MATCH** key (2) to acquire the valve position.

The OP.2 reading appears.

An incorrect valve position entry can be corrected afterwards.

### Weight minimisation

If no optimisation, but only weight minimisation (i.e. without compensation run for the rim without tyre), proceed as follows:

- Clamp the complete wheel (rim and tyre).
- Press **F** (1) + **PRO-MATCH** (2) if minimisation is starter separately from optimisation.

The OP.1 reading appears.

- Press the **F** key (1) to activate the weight minimisation program.

The Un.3 reading appears. Run the minimisation program.

- With program OP.2 the rim compensation run can still be omitted. Go to the next step in the program by pressing the **F** key (1).

The UN.4 reading appears.

- Continue the minimisation program.

The valve position entered with OP.1 is automatically used.

### Continuing balancing optimisation

- Press the **START** key (3) to start the rim compensation run without the tyre.

After the measuring run the OP.3 reading appears.

- Mount the tire and inflate correctly (see note below).

### Note

For mounting and demounting (tire changer) and tire turning or readjustment on the rim, always apply a sufficient amount of tire lubricant on the tire beads and the rim edges and shoulders. Each time the position of the tire is changed on the rim, inflate the tire to overpressure (approx. 3.5 bar) then deflate to correct tire pressure.

Make sure the centering line is correctly positioned on the tire bead.

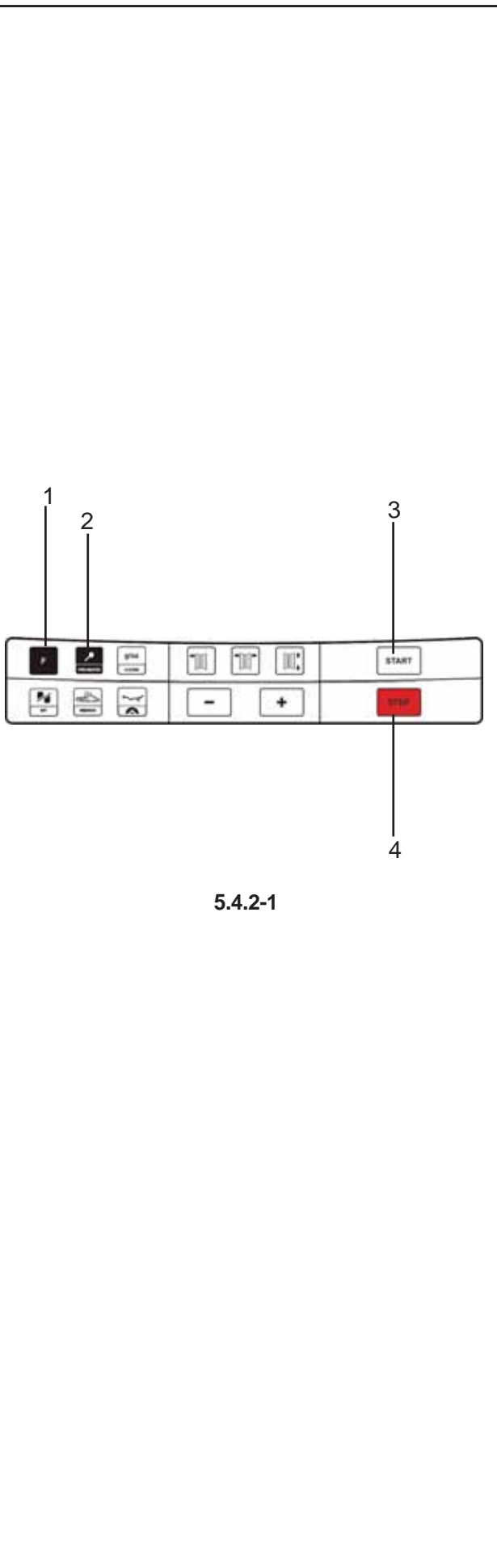

## Operation

- Clamp the wheel.
- Position the valve exactly perpendicular to and above the main shaft.
- Press the **PRO-MATCH** key (2) to acquire the valve position.

OP.4 appears.

- Press the **START** key.

The measuring run is carried out. After the measuring run two readings are possible:

### OP.5 - H1

Further optimisation is not recommended, but possible.

### OP.5 – Reference mark

Continue with the OP program.

### Reading OP.5 - H1

If OP.5 - H1 appears, further optimisation is not recommended, since the measurement values which activated the optimisation recommendation are below the limit value. However, it is possible to continue optimisation for the most silent possible wheel running, reducing imbalances below the limit value (critical vehicle).

To continue optimisation

- To continue with the OP program proceed as specified for OP.5 – Reference mark (see next page).

To abort optimisation

- Press the **STOP** key to return to the balancing program and balance the wheel according to the readings.

### Reading OP.5 - Reference mark

- After the measuring run readjust the wheel following the direction indicator and make a chalk mark on the right side of the tire exactly perpendicular to and above the main shaft.
- Readjust the tire on the rim so that the reference mark made is aligned with the valve (use tire changer).
- Clamp the wheel on the balancer and readjust it until the valve is exactly perpendicular to and above the main shaft.
- Press the **PRO-MATCH** key (2) to acquire the valve position.

The OP.6 reading appears.

- Press the **START** key.

After the measuring run four readings are possible:

### === - OP.7

Proceed with the OP program. It is recommended that the tire be turned over on the rim.

### OP.7 - ===

Proceed with the OP program. It is recommended that the tire be turned over on the rim.

### H0

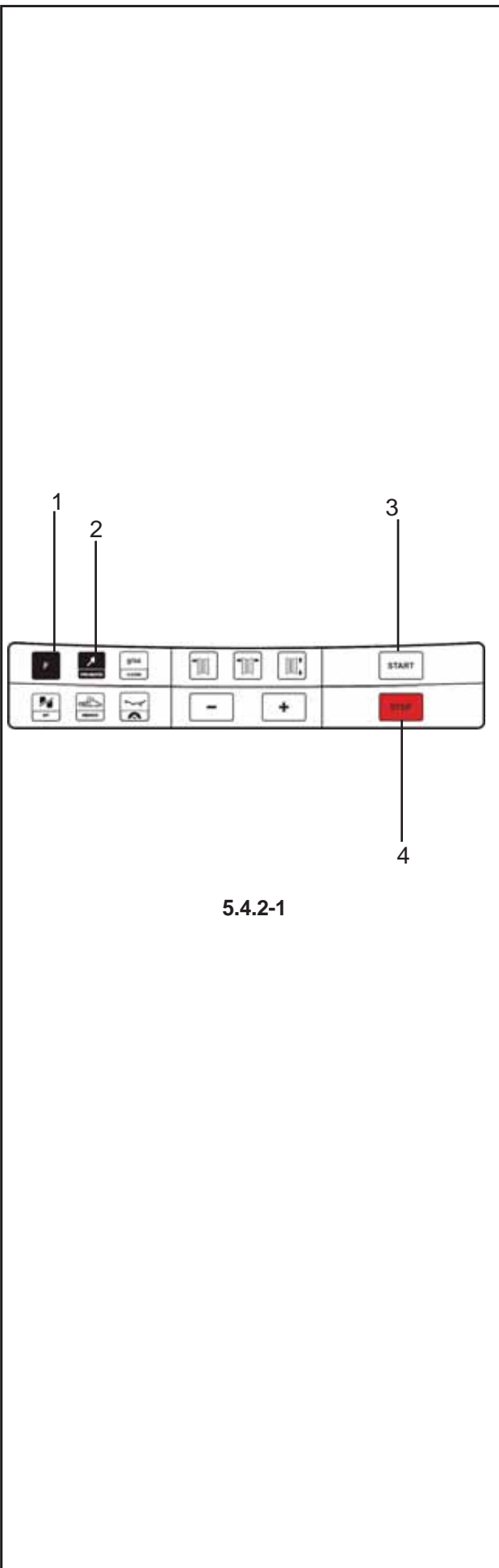

5.4.2-1

## Operation

Optimum condition has been achieved and cannot be improved.

### H2

Silent running cannot be improved.

However, it is possible to readjust the tire relative to the rim to achieve significant weight minimisation (i.e.: smaller balance weights) without having an adverse effect on silent running.

Depending on the readings, there are several possibilities for proceeding with the program. These possibilities are described below.

### Reading === - OP.7

Turn the tire over on the rim (the left display bars are rotating).

**Option 1:** Turn the tire over on the rim (normal program).

- Readjust the wheel according to the left direction indicator and make a double mark on the left side of the tire exactly perpendicular to and above the main shaft.

- Remove the wheel from the machine.

- Turn the tire over on the rim and readjust until the double mark coincides with the valve.

- Clamp the wheel on the balancer and readjust it so that the valve is exactly perpendicular to and above the main shaft.

- Press the **PRO-MATCH** key (2) to acquire the valve position.

Reading OP.8 appears.

- Press the **START** key (3) (check run).

If balancing optimisation (silent running) has been carried out correctly (according to the program cycle), after the check run the machine automatically returns to the type of weight positioning previously selected and indicates the residual dynamic imbalance on the wheel.

- Balance the wheel according to the readings.

Both optimisation and balancing are accomplished.

### Message E9

Message E9 means that at least one error occurred during the optimisation cycle. Press the **STOP** key (4) to exit the optimisation program and repeat optimisation if necessary.

**Option 2:** Do not turn the tire over on the rim

- Press the F key (1).

The result is recalculated.

Reading OP.7 - = = = or H0 or H2 appears

- To go to === - OP.7 (turning over the tyre) press the **F** key (1) again.

**Option 3:** Abort optimisation

- Press the **STOP** key (4) to exit the OP program and return to the balancing program

The imbalance on the wheel is shown on the readout.

- Balance the wheel according to the readings.

### Reading OP.7 - ===

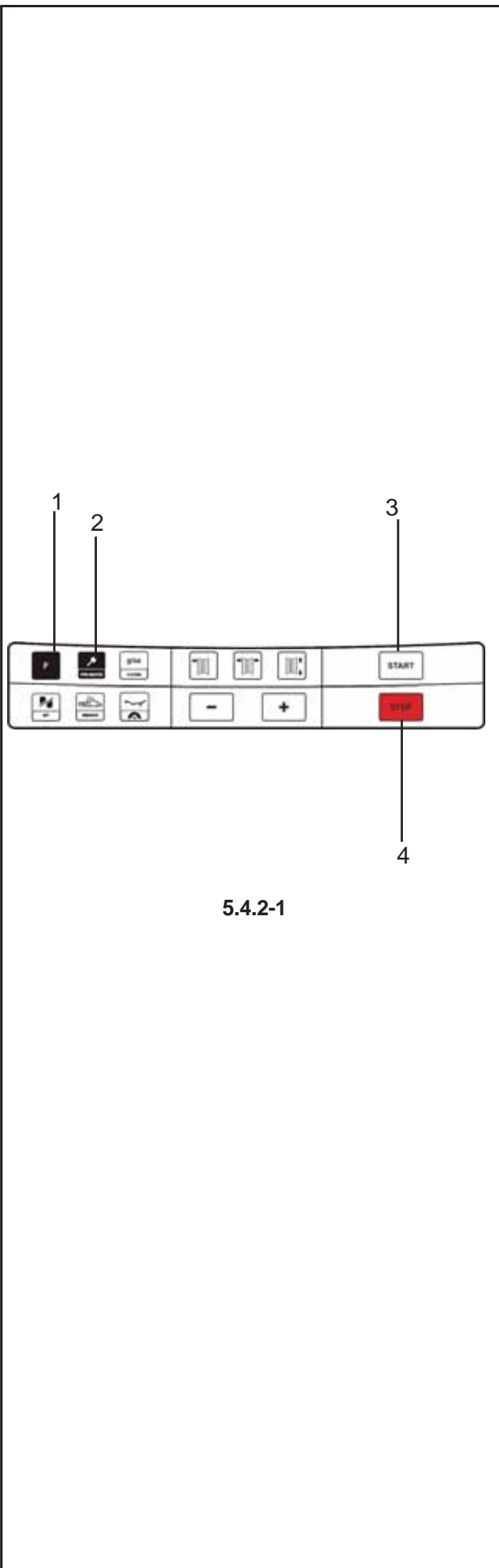



## Operation

Readjust the tire on the rim (the right display bars light up permanently).

**Option 1:** Readjust the tire on the rim (normal program)

- Readjust the wheel following the right direction indicator and make a double mark on the right side of the tire exactly perpendicular to and above the main shaft.
- Remove the wheel from the machine
- Readjust the tire on the rim until the double mark coincides with the valve.
- Clamp the wheel on the balancer and readjust so that the valve is exactly perpendicular to and above the main shaft.
- Press the **PRO-MATCH** key (2) to acquire the valve position.

Reading OP.8 appears.

- Press the **START** key (3) (check run).

If balancing optimisation (silent running) has been carried out correctly according to the program cycle, after the check run the machine automatically returns to the type of weight positioning previously selected and indicates the residual dynamic imbalance on the wheel.

- Balance the wheel according to the readings. Both optimisation and balancing are accomplished.

### Message E9

Message E9 means that at least one error occurred during the optimisation cycle. Press the STOP key (4) to exit the optimisation program and repeat optimisation if necessary.

**Option 2:** do not adjust the tire on the rim

- Press the **STOP** key (4) to exit the OP program and return to the balancing program. The imbalance on the wheel is shown on the readout.
- Balance the wheel according to the readings.

### Reading H0

- Press the **STOP** key (4) to exit the OP program and return to the balancing program. The imbalance on the wheel is shown on the readout.
- Balance the wheel according to the readings.

The optimum balancing optimisation condition has been achieved and cannot be improved.

### Reading H2

Silent wheel running cannot be improved. However, it is possible to achieve weight minimisation (readings with code UN.).

**Option 1:** Weight minimisation

- Press the **F** key to continue the program. As a result reading is === - Un.7 or Un.7 - ===

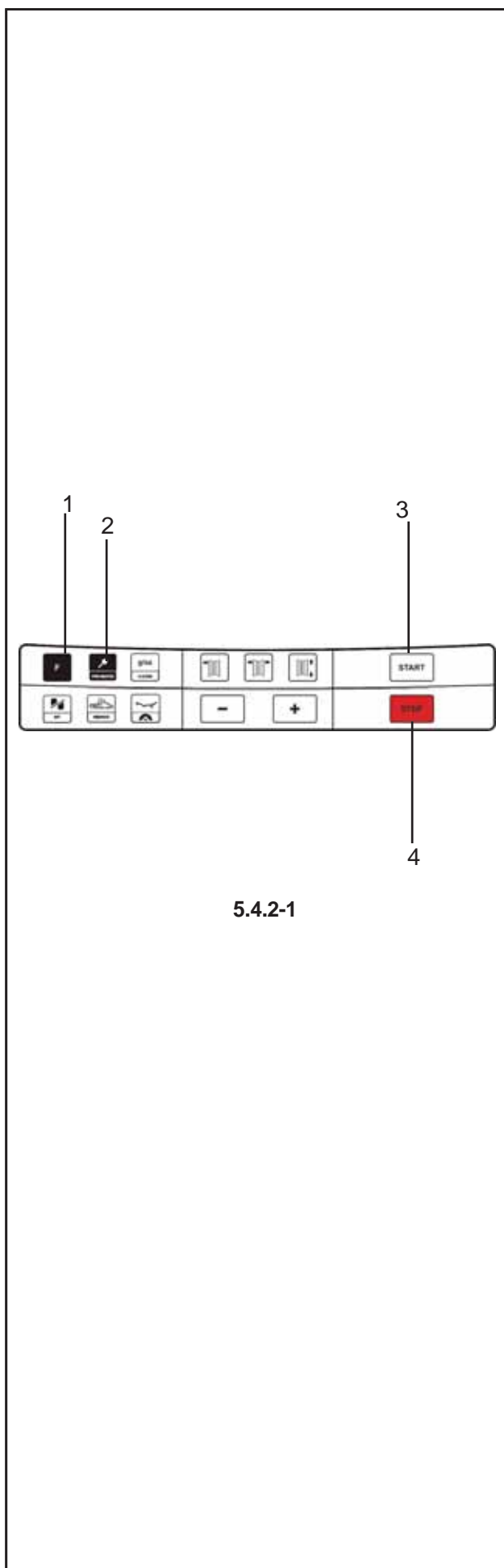

5.4.2-1

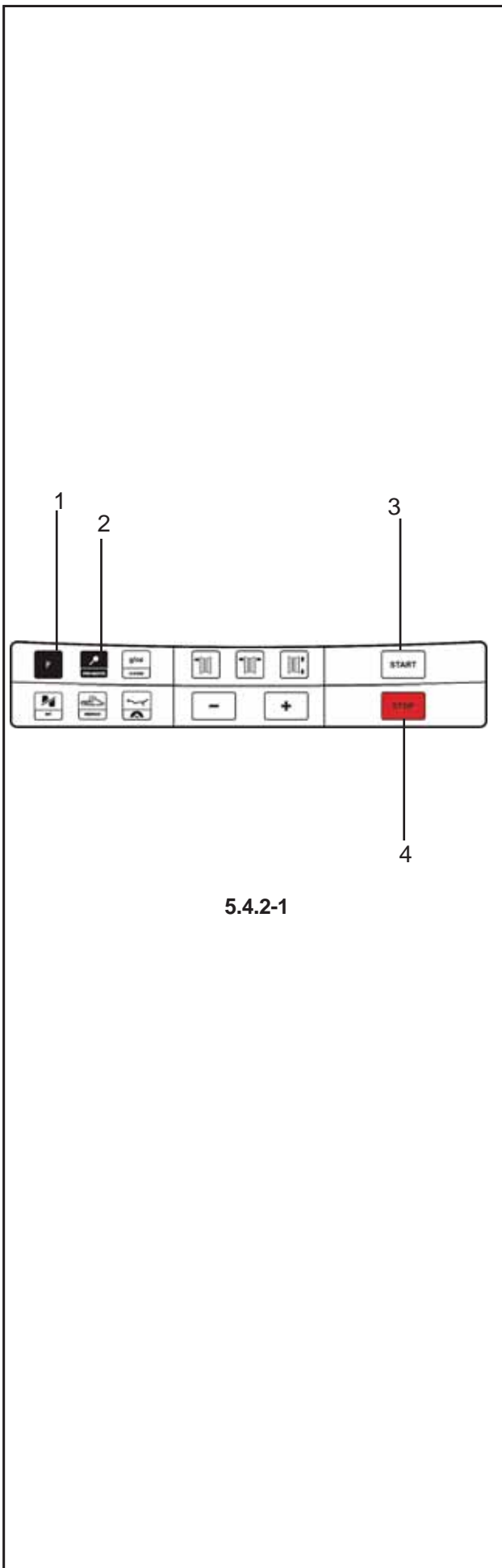

5.4.2-1

**Option 2:** Abort optimization

- Press the **STOP** key (4) to exit the OP program and return to the balancing program.
- The imbalance on the wheel is shown on the readout.
- Balance the wheel according to the readings.

**Weight minimisation program cycle**

If the rim compensation run was omitted and the **F** key (1) was pressed to go directly into the minimization program (reading Un.), proceed as follows.

- Clamp the wheel.
- Position the valve exactly perpendicular to and above the main shaft.
- Press the **PRO-MATCH** key (2) to acquire the valve position.

Reading Un.4 appears.

- Press the **START** key (3).

The measuring run is carried out. After the measuring run two readings are possible:

**Un.5 - H1**

Further minimisation is not recommended, but is possible.

**Un.5 – Reference mark**

Continue with the UN program.

**Reading Un.5 - H1**

If Un.5 - H1 appears, further minimisation is not recommended since the measurement values do not exceed the limit values. However, it is possible to continue minimisation so as to achieve an improvement, if only slight (e.g.: for critical vehicles).

To continue minimisation:

- Proceed as indicated for reading Un.5 – Reference mark.

To abort minimisation:

- Press the **STOP** key to return to the balancing program and balance the wheel according to the readings.

**Reading Un.5 – Reference mark**

- After the measuring run readjust the wheel according to the direction indicator and make a chalk mark on the right side of the tire exactly perpendicular to and above the main shaft.
- Readjust the tire on the rim so that the mark coincides with the valve (use the tire changer).
- Clamp the wheel on the balancer and readjust it so that the valve is exactly perpendicular to and above the main shaft.
- Press the **PRO-MATCH** key (2) to acquire the valve position.

Reading Un.6 appears.

- Press the **START** key (3).

## Operation

The machine performs the second measuring run with the tire. After the measuring run three readings are possible:

### === - Un.7

Proceed with the UN program. It is recommended that the tire be turned over on the rim.

### Un.7 - ===

Proceed with the UN program. It is recommended that the tire be readjusted on the rim.

### H0

The optimum minimisation condition has been achieved and cannot be improved.

Depending on the readings, there are several possibilities for proceeding with the program. These possibilities are described below.

### Reading === - Un.7

Turn the tire over on the rim (the left display bars are rotating).

**Option 1:** Turn the tire over on the rim (normal program)

- Readjust the wheel according to the left direction indicator and make a double mark on the left side of the tire exactly perpendicular to and above the main shaft.
- Remove the wheel from the machine.
- Turn the tire over on the rim and readjust until the double mark coincides with the valve.
- Clamp the wheel on the balancer and readjust it so that the valve is exactly perpendicular to and above the main shaft.
- Press the **PRO-MATCH** key (2) to acquire the valve position.

Reading Un.8 appears.

- Press the **START** key (3) (check run).

If weight minimisation was carried out correctly (according to the program cycle), after the check run the machine automatically returns to the type of weight positioning previously selected and indicates the residual dynamic imbalance on the wheel.

- Balance the wheel according to the readings.

Both weight minimisation and balancing are accomplished.

### Message E9

Message E9 means that at least one error occurred during the minimisation cycle. Press the **STOP** key (4) to exit the minimisation program and repeat minimisation if necessary.

**Option 2:** Do not turn the tire over on the rim

- Press the **F** key (1).

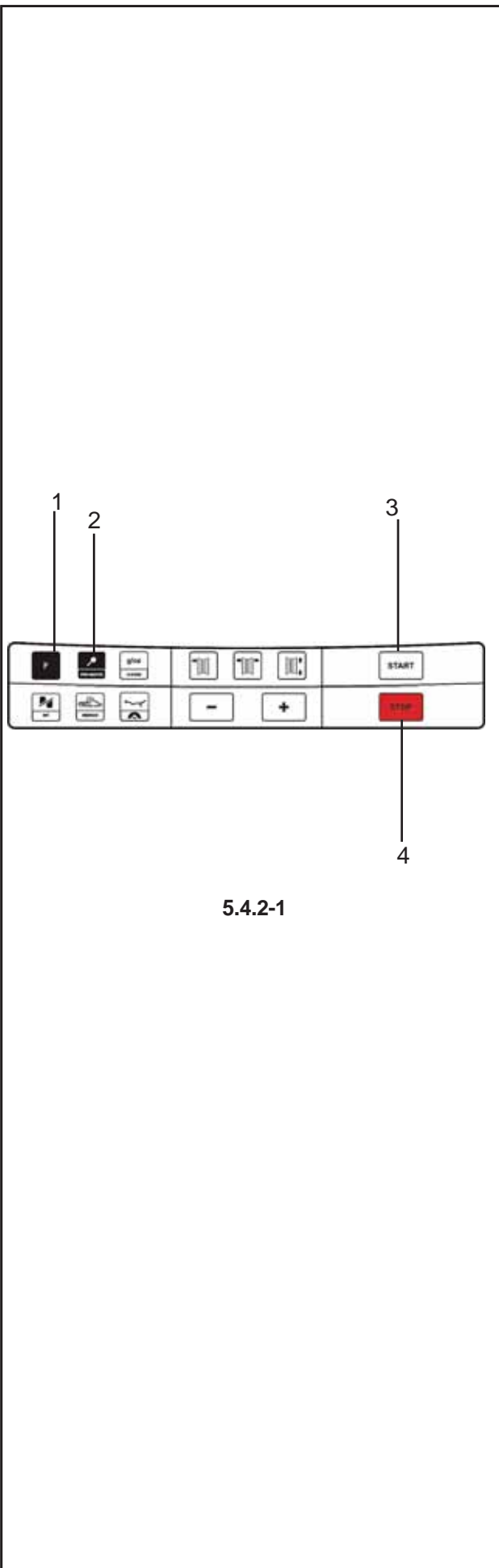

## Operation

The result is recalculated.

Reading Un.7 - == = or H0 appears

- To return to == = - Un.7 (turning over the tyre) press the **F** key (1) again.

### Option 3:

- Press the **STOP** key (4) to exit the minimisation program and return to the balancing program

The imbalance on the wheel is shown on the readout.

- Balance the wheel according to the readings.

### Reading Un.7 - == =

Readjust tire on the rim (the right display bars light up permanently).

**Option 1:** Readjust the tire on the rim (normal program)

- Readjust the wheel according to the right direction indicator and make a double mark on the right side of the tire exactly perpendicular to and above the main shaft.

- Remove the wheel from the machine.

- Readjust the tire on the rim until the double mark coincides with the valve.

- Clamp the wheel on the balancer and readjust it so that the valve is exactly perpendicular to and above the main shaft.

- Press the **PRO-MATCH** key (2) to acquire the valve position.

Reading Un.8 appears.

- Press the **START** key (3) (check run).

If weight minimisation was carried out correctly (according to the program cycle), the machine automatically returns to the type of weight positioning previously selected and indicates the residual dynamic imbalance on the wheel.

- Balance the wheel according to the readings.

Both weight minimisation and balancing are accomplished.

### Message E9

Message E9 means that at least one error occurred during the minimisation cycle. Press the **STOP** key (4) to exit the minimisation program and repeat minimisation if necessary.

**Option 2: Do not** readjust the tire on the rim

- Press the **STOP** key (4) to exit the minimisation program and return to the balancing program

The imbalance on the wheel is shown on the readout.

- Balance the wheel according to the readings.

### Reading H0

The optimum minimisation condition has been achieved and cannot be improved.

- Press the **STOP** key (4) to return to the balancing program and continue according to the readings.

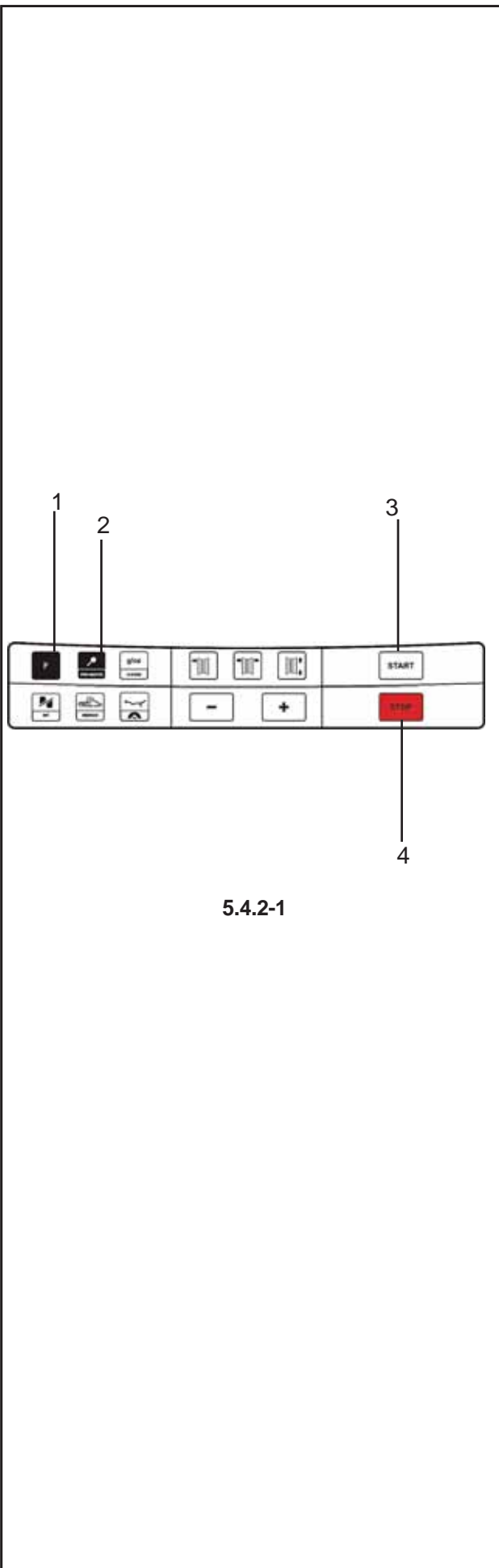

5.4.2-1

## 5.5 Special functions

In this chapter all functions that may be accessed by the operator are described. A special function is a “mode” that is not necessarily required to balance a wheel properly.

### 5.5.1 Non-skid function

On wheels with a limited weight, skid specifications may make it impossible to perform a run at the normal measuring speed.

This function may be disabled for a single run:

- Hold the **START** key down while the wheel guard is lowered.

**Note:** the machine will start the wheel spinning gradually in order to stop it from skidding and avoiding the consequent error messages (E17).

## 5.6 Calibration

This chapter describes the calibrations that can be performed by the operator.

### 5.6.1 User calibration

If a number of different measuring runs have to be performed to balance a wheel and the values and positions of the weights have to be changed, it generally means that measuring is not precise.

In this case the operator can recalibrate the machine. To perform a so-called "User Calibration", the operator should use the calibration weight (réf. EAM0005D40A) supplied with the machine (situated at the back of the weights shelf)

A calibration run usually lasts longer than a measuring run.

Clamping element imbalance compensation is deleted following a User Calibration.

**Important:**

Before performing a User Calibration ensure the clamping device supplied by the manufacturer is fitted.

**Calibration** (Cod. C14)

- Make sure that only the clamping device is fitted to the main shaft (no wheel or any other clamping accessories).

- **Press F + C-Code.**

The base C 0 value is displayed.

- Use the + and - keys to select the **C14** Code.
- Press the **C-Code** key.

Step 1 is displayed.

- Close the wheel guard, press the START key (if necessary) to perform the first calibration run (a longer measuring run to detect any residual imbalances).

At the end of the first calibration run Step 2 is displayed.

- Screw the calibration weight into the threaded bore on the machine flange (Figure 5.6.1-1).
- Press the START key to perform the second calibration run (with the calibration weight to detect the adjustment values).

After the second measuring run, the electronic system processes the values registered in the calibration runs and saves them in the permanent memory. At the end of the processing phase the machine sounds a three tone beep to indicate that recalibration is complete. The machine is now ready to use again and the base value is displayed.

- At the end of the calibration procedure unscrew the calibration weight from the flange and put it back in its place.

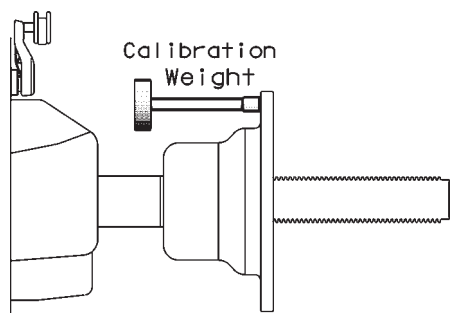

5.6.1-1

## 5.7 Selecting the operating mode

To use the balancer normally you do not need to change the operating mode and the relative states set by the manufacturer. In special cases, however, or if working conditions require it, the operating modes and states can be changed by entering the appropriate codes.

### Operating mode settings and values

- Press **F** (1) + **C-Code** (2) to enter the C-Code mode.
- Use the **+** and **-** keys (3) e (4) to select the relevant C-Code, displayed on the left indicator (5). Press the **C-Code** to confirm.
- Use the **+** and **-** keys to select the relevant operating state, displayed on the right indicator (6). Press the **C-Code** to confirm and return to the base value - Fig. 5.7-2.

This changes the operating mode which is then saved until a new setting is entered or until the machine is turned OFF.

The operating modes that are changed in this way can be saved permanently using the C10 code. Now if the machine is turned OFF these modes are not lost and every time the machine is turned ON they are reinserted until they are changed again.

Code C4. Clamping device compensation

This cannot be saved permanently.

The editing codes and the key combinations for entering them are listed below.

.

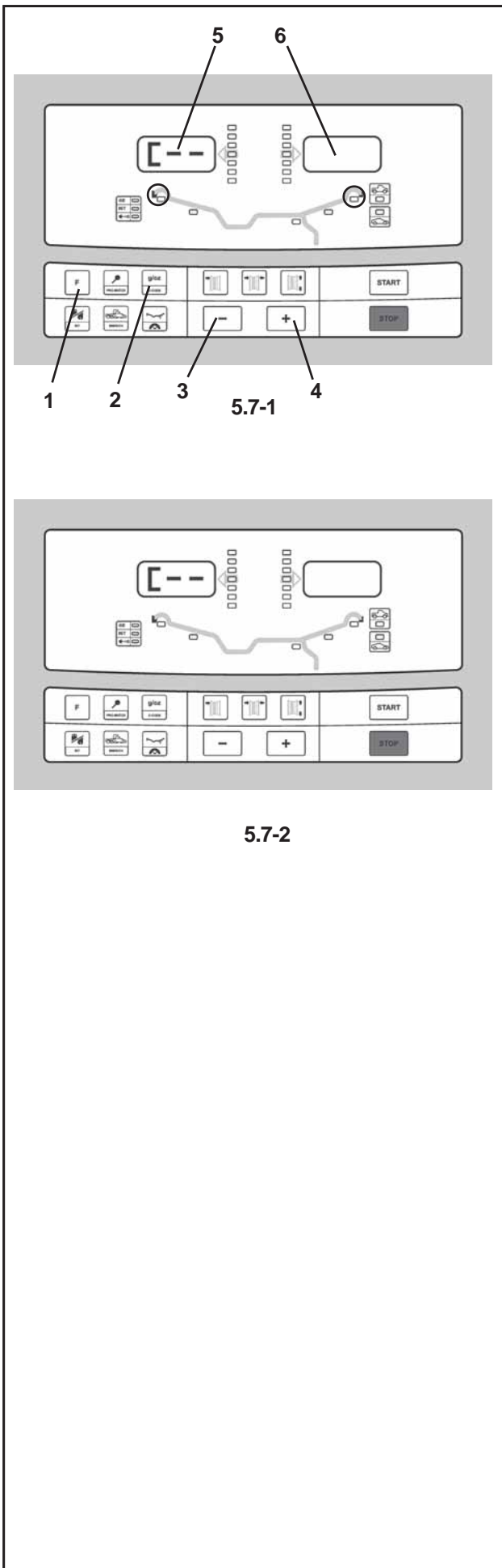

Operation

### Code C0

**Figure 5.7-3** setting operating modes preset by the manufacturer

0\* = No action

1 = Set values preset by the manufacturer (state 1 is displayed only briefly)

The operating mode selected can be obtained from the permanent memory.

### Code C1

**Figure 5.7-4** Selecting the definition of the imbalance value in steps from 1 or 5 grams (= from 0.05 to 0.25 oz.).

0\* = 5 gram (0.25 oz) definition

1 = 1 gram (0.05 oz) definition

The operating mode selected can be obtained from the permanent memory.

### Code C2

**Figure 5.7-5** Selecting the suppression of minor imbalance values.

0 = Suppression OFF

1\* = Suppression ON

The operating mode selected can be obtained from the permanent memory.

### Code C3

**Figure 5.7-6** Selecting the unit of measure for indicating the imbalance (grams/oz) activated after the machine has come on.

0 = Value in grams

1\* = Value in oz

The operating mode selected can be obtained from the permanent memory.

\*=preset by the manufacturer

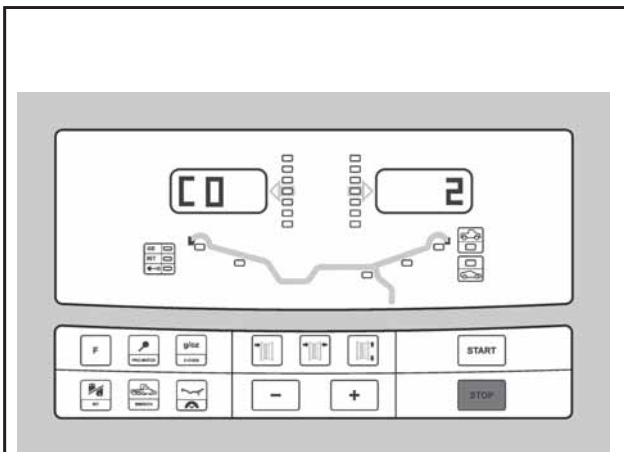

5.7-3

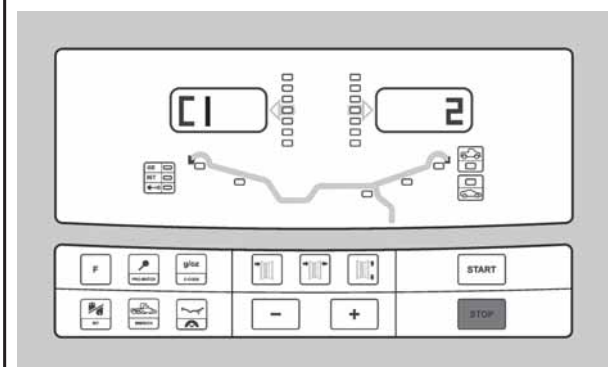

5.7-4

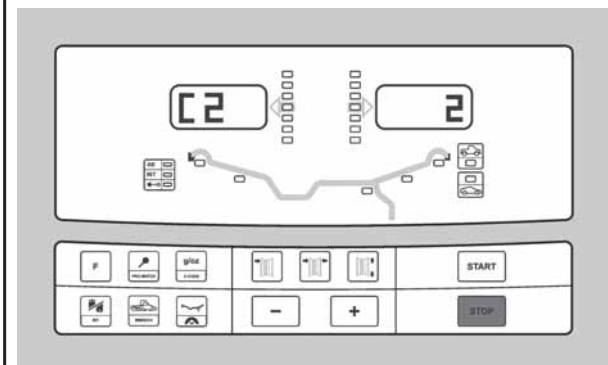

5.7-5

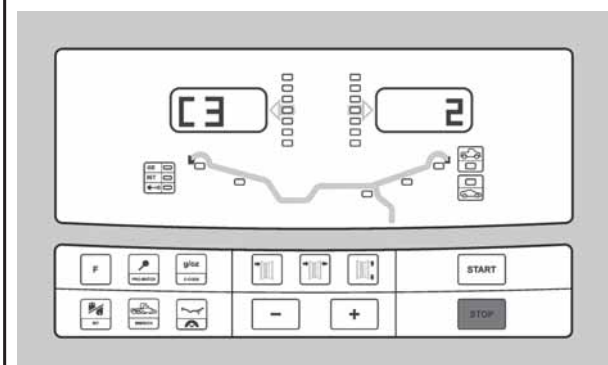

5.7-6



**Code C4**

**Figure 5.7-7** Eventual residual clamping device imbalance compensation.

High precision measuring (This operating mode cannot be stored in the permanent memory).

Once compensation has been performed, if the clamping device is changed, this value must be deleted or recalculated using the new device.

To delete clamping device compensation, set the operating state to 0.

Compensation should be deleted when the machine is calibrated or recalibrated, if imbalance optimisation (silencing) is performed or if the machine is turned OFF.

0 = Perform compensation

1 = Compensation performed

0 = Disable compensation after the measuring run

**Code C6**

**Figure 5.7-8** Entering the number of wheel spins per measuring run. Between 5 and 25 spins are possible, preset by the manufacturer at 10 spins per run.

Example > change to 15 spins per run.

**WARNING: REDUCING THE NUMBER OF SPINS PER RUN MEANS THAT THE MEASUREMENT WILL BE LESS PRECISE.**

The operating mode selected can be obtained from the permanent memory.

**Code C7**

**Figure 5.7-9** Adjusting beep volume, from 0 to 100 (quiet - loud) preset by the manufacturer at 50\*.

Example: Change volume to 60.

To confirm the volume change, exit the function by pressing the C key.

The operating mode selected can be obtained from the permanent memory.

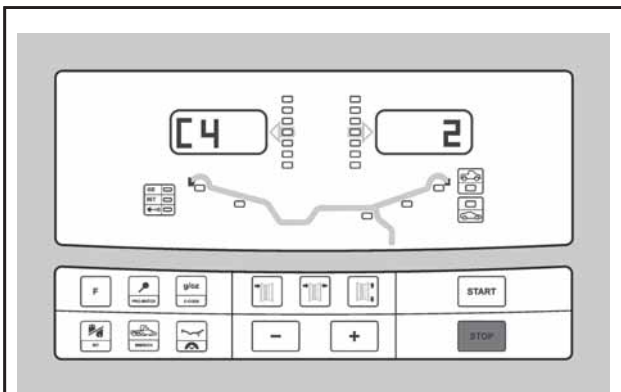

5.7-7

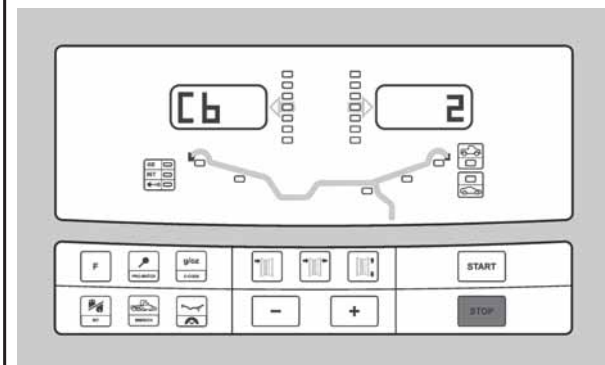

5.7-8

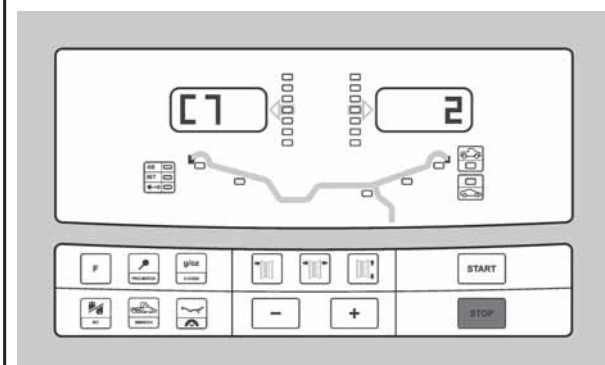

5.7-9

**Code C8**

**Figure 5.7-10** Selecting the threshold value for suppressing minor imbalances in grams or oz. The unit of measure depends on the C3 code setting.

**Unit of measure: grams:**  
see table at end of manual.

**Unit of measure: oz:**  
see table at end of manual.

The operating mode selected can be obtained from the permanent memory.

**Code C10**

**Figure 5.7-11** Saving an operating mode in the permanent memory.

- 0\* = Don't save
- 1 = Save the data in the permanent memory.
- The machine sounds a three tone beep to confirm that the data has been saved permanently.

If you have to save the operating mode permanently, first change the state, e.g. activate it, disable it and then save it in the permanent memory using the C10 code (this does not apply to C4).

**Code C12**

**Figure 5.7-12** Measuring run counter.

Example: 222.123 measuring runs performed  
Press the Fine key and spin the wheel to display the following counters:

- 1 = Total nr. of measuring runs performed
- 2 = Total nr. of measuring runs with a positive balancing result (OK)
- 3 = Total nr. of optimisations and minimisations
- 4 = Total nr. of measuring runs in Service mode
- 5 = Total nr. of measuring runs since the last calibration

Every measuring run that is performed and concluded is memorised. The counter can count up to 999,999 measuring runs. When this number is reached the counter starts again from 0. This information is interesting in terms of statistics, e.g. to demonstrate how long faulty parts have lasted or to calculate how much the machine is used per month or per year.

The measuring cycles performed while the machine is running are saved in the permanent memory and totalled every time the machine is turned OFF. Counter totals cannot be deleted.

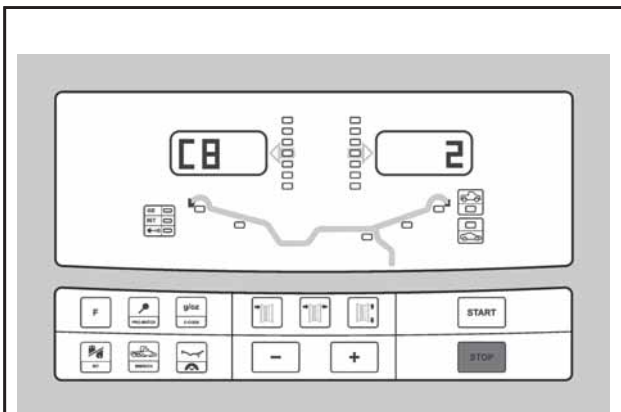

5.7-10

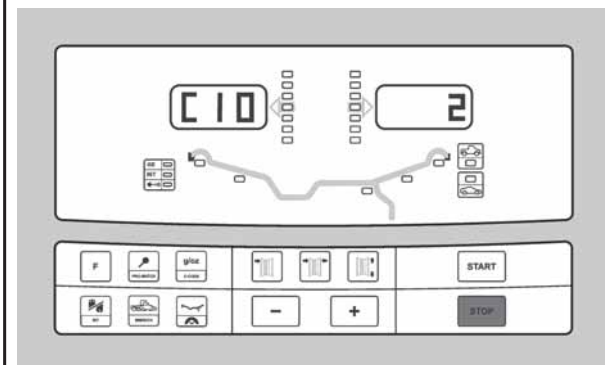

5.7-11

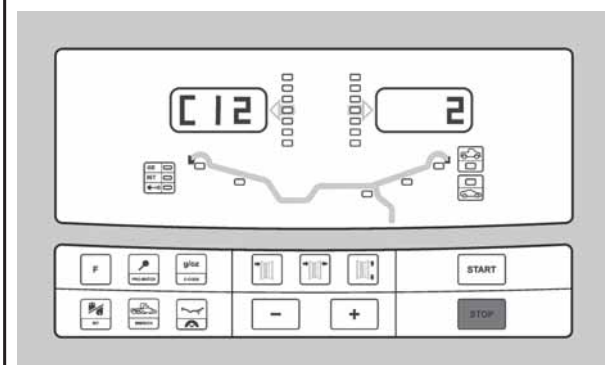

5.7-12

## Operation

### Code C13

**Figure 5.7-13** Starting a measuring run by lowering the wheel guard

- 0\* = Start a run using the START key
- 1 = Start a run by lowering the wheel guard

The operating mode selected can be obtained from the permanent memory.

### Code C14

**Figure 5.7-14** User recalibration.

### Code C21

**Figure 5.7-15** This displays the program version number and the model number.

Program version 1,22 for mod. 980L.

- to display the program version number release the **C** key.
- to display the model number press the Fine key.

### Code C28

**Figure 5.7-16** Selecting one of 10 messages from the error memory and deleting them from the error memory.

The last 10, unrepeated error messages are saved in the error memory so that the balancer user can trace malfunctioning via remote diagnosis. The last error message is saved in the nr.1 memory slot. The previous messages are stored in order of arrival in the memory list.

- Select one of the 10 error messages.
- Press the OP key to display the number of the error message (left) and the total number of times the message has appeared (right), e.g. the error in memory slot 7 has appeared 4 times.
- For the 2nd step press the C key.
- Press and hold down the Fine key, spin the wheel and set the relevant code:
  - 0 = Do not delete the error memory
  - 1 = Delete the error memory

\* = Factory adjusted mode

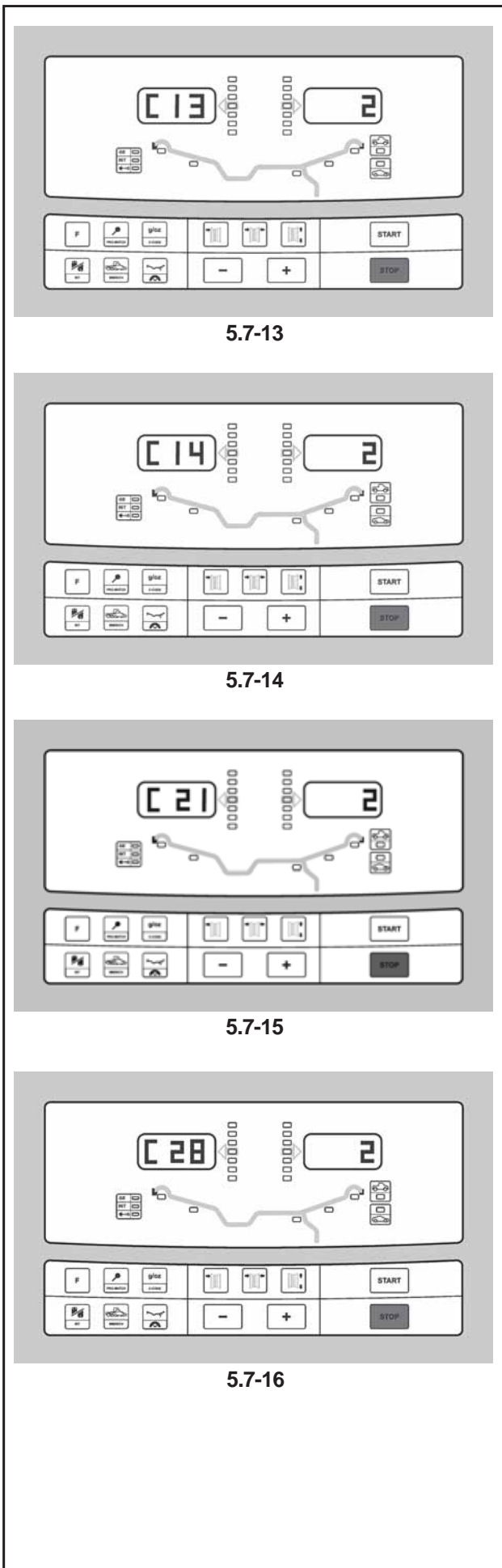

## 6.0 Maintenance

This unit is designed to operate for a long time. At start-up the operator should check if all indicators and displays light up.

If the operator shuts down correctly (Chapter 5.2.3) at the end of each shift, no further maintenance is required.

This unit must not be opened by the operator, apart from following the instructions below.

### 6.1 Storage

When the unit will be stored for a several weeks or longer, prepare the unit correctly:

- Shut down the unit properly, refer to Chapter 5.2.3.
- Remove the threaded shaft from the balancer.
- Apply a thin layer of non-corrosive oil on all threads and cones.
- Wrap oiled items in paper to keep the parts dust-free.

Before putting the unit into use again, clean all oiled parts.

### 6.2 Changing the mains fuse

Refer to Figure 6.2-1.

- Switch off the unit.
- Unplug the power cable from the power outlet.
- Remove the power cable from the machine mains socket.
- Press the fuse holder central tab upwards.
- Pull out the fuse holder.
- Replace the fuse with another fuse having an identical rating.
- Return the unit to its original state.

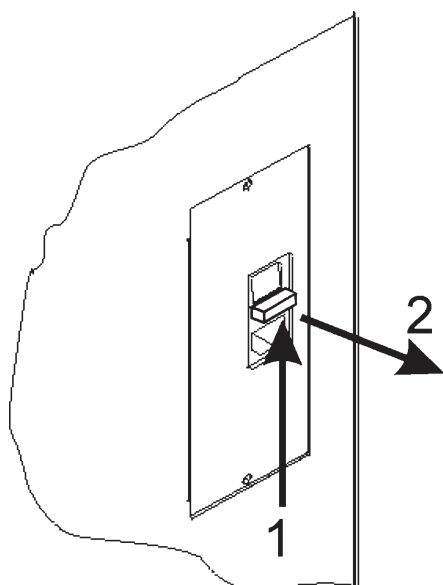

6.2-1

## 7.0 Trouble shooting

If a problem arises with the wheel balancer, proceed in the following order to solve the problem:

1. Rethink the last steps taken.  
Did you work according to the manual?  
Did the unit work as described and expected?
2. Check the unit according to the points listed in this chapter.
3. Call your local sales agent for technical service.

The set up of this chapter is:

### **Problem**

1. Possible cause #1
  - Possible solution(s)
2. Possible cause #2
  - Possible solution(s)

### **When switched on, nothing lights up.**

1. Power switch in OFF position (not applicable for handspin balancers).
  - Set power switch in ON position.
2. No power cable connected.
  - Connect power cable to power outlet.
3. No mains power
  - Check power supply, power system fuses
4. Unit fuse(s) blown.
  - Replace unit fuse(s).  
If the fuse(s) has (have) recently been replaced, call service to check the unit.

### **When switched on, a beep is heard for 1 second.**

1. Configuration error.
  - Call Service Team

### **When switched on, the unit beeps with a certain sequence.**

- Note down the sequence.
- Call Service Team

### **Display appears to freeze or lock up.**

1. The unit may be in a program, waiting for a specific action.
  - Finish the program currently in use.
  - Switch off the unit.  
Wait for 20 seconds, switch on the unit.  
Proceed.
2. Power to the balancer may have been interrupted.
  - Switch off the unit.  
Wait for 20 seconds, switch on the unit.  
Proceed.
  - If this happens frequently, have your power system checked. If that is okay, call technical service team.

**Gauge arm inputs differ from wheel dimensions stated on rim or tire.**

1. Did you position the gauge arm correctly?
  - Refer to Chapter 5.3.1.
2. Check the offset input of the gauge arm by entering manually.
  - Refer to the scale on the gauge.
  - If not identical, proceed with step 4.
3. Check the diameter of the spot on the rim where the diameter has been measured.
  - If not identical, proceed with step 4.
4. Calibration is required.
  - Have the gauge arm calibrated.

**Balancing results are unreliable.**

1. The balancer may not be installed properly.
  - Make sure the unit rests on its 3 feet only.
  - Make sure the floor is not relaying shocks, for example from trucks passing close to the unit.
2. The wheel may be mounted incorrectly.
  - Check the hub, cones and adapters for play.
  - Use appropriate spacers to eliminate play.
  - Perform measuring unit calibration.
3. The electronics are faulty.
  - Call service team.

**A mode, display segment or indicator is continuously shown on the display.**

1. A power dip may have occurred.
  - Switch off the unit.
  - Wait for 20 seconds, switch on the unit.
- Call service team.

## 7.1 System messages

The wheel balancer can show messages to the operator. These may be error related (E-codes) or warnings (H-codes). The codes will be described in the following chapters.

Whenever a code appears:

- make a note of it;
- look up the code in the list. If the code is not described, call service team;
- perform the steps described.

### 7.1.1 E-Codes / H-codes

#### **E1**

Rim dimensions set are incorrect or incomplete. When the message appears, set the data again.

#### **E2**

Wheel guard is not closed.

#### **E3**

The gauge for measuring the distance and diameter is not in the home position.

#### **E5**

Compensation range was exceeded.  
(Clamping means with excessive imbalance).  
Press the STOP key.  
Check the clamping means and repeat the compensation run.

#### **E6**

The calibration weight was not attached for calibration.  
Press the STOP key.  
Repeat calibration.

#### **E7**

With this weight mode selection of a type of weight positioning is not possible.  
If possible, select another weight mode.

#### **E8**

Valve position was not set (message only appears with balancing optimisation / weight minimisation program).  
Position the valve so that it is exactly perpendicular to and above the main shaft and press the PRO-MATCH key.

## Trouble shooting

### **E9**

Optimisation / minimisation was not carried out correctly.

1. Wheel was not exactly centered on clamping means for at least one run.
  2. Tire was not centered on rim for at least one run.
  3. Valve position was not set and acquired correctly at least once.
  4. Wrong reference mark (single or double) was used when readjusting the tire.
  5. Wheel moved on clamping means during a measuring run (sudden start or braking).
  6. Wheel dimensions were not set correctly.
- Repeat optimisation.

### **E15**

Recalibration correction is out of range.

During recalibration values above or below the calibration value envisaged were found. This message is only a warning. Press key C to transfer the correction values to the permanent memory.

Use the clamping means supplied with the machine or perform basic calibration (Service).

### **E16**

During the first recalibration run the calibration weight was attached by mistake.

Unscrew the calibration weight and press START.

### **E17**

Wheel slips on clamping means.

The clamping nut is not tightened properly, the main shaft accelerates too quickly. The machine will stop.

Firmly tighten the clamping nut and in special cases press the START key for longer.

### **E83**

During a measuring run the values measured are rendered useless due to outside interference pulses (e.g.: strong vibrations). The run is interrupted.

Repeat the measuring run.

### **E88**

The main shaft speed exceeds the safety limit.



**E89**

A key is jammed.  
Find and release jammed key.

If the error cannot be eliminated, the pedal function is switched off by pressing the STOP key or the ESC key. Call service team.

**E92**

The gauge for measuring the distance and diameter is faulty.

Call service team.

As long as the geodata measuring gauge is defective, set the distance and rim dimensions using the menu key and turning the wheel (Chapter 2.3.3).

**H0 - Figure 7.1.1-1**

Wheel silent running cannot be improved with balancing optimisation.

**H1 - Figure 7.1.1-2**

Further optimisation is not recommended but is possible.

**H2 - Figure 7.1.1-3**

Weight minimisation is recommended, further optimisation does not bring improvements.

**H20 - Figure 7.1.1-4**

Correction plane cannot be found with the gauge for measuring distance and diameter.

Measure the correction plane and set the dynamic imbalance indicator.

**H21 - Figure 7.1.1-5**

The position reached does not correspond to the correction plane, in which the stick-on weight must be applied with the gauge.

Turn the wheel to the position for application of the stick-on weight on the relative correction plane.

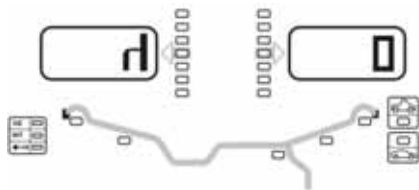

7.1.1-1



7.1.1-2



7.1.1-3



7.1.1-4



7.1.1-5

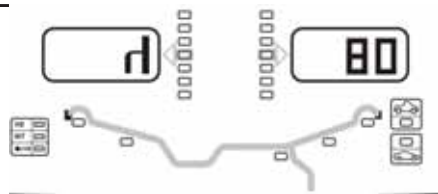

7.1.1-8

**H80 - Figure 7.1.1-8**

Recalibration was not set up. As a result, it cannot be performed by the operator.

Press the STOP key to clear the message.

Call the service team for machine calibration.

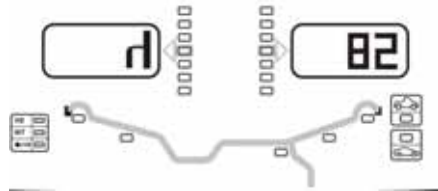

7.1.1-9

**H82 - Figure 7.1.1-9**

The self-test was disturbed (e.g.: by turning the wheel). The message is displayed for 3 seconds, then the measurement is repeated (max. 10 times) or aborted by pressing the STOP key.

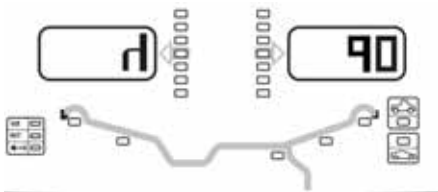

7.1.1-10

**H90 - Figure 7.1.1-10**

Wheel acceleration was too slow, or braking was too weak after a measuring run.

If the main shaft does not reach the required speed, check that the brake is not activated or the weight of the wheel is too great. In this case:

Release the brake.

Make sure that the shaft with the wheel clamped on it can rotate freely.

Turn the wheel by hand then press the START key.

If the error cannot be eliminated, call the service team.

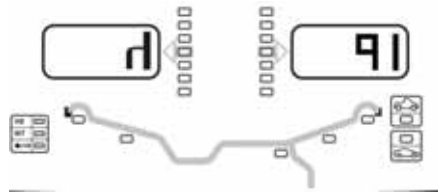

7.1.1-11

**H91 - Figure 7.1.1-11**

Speed variations during measuring run. The brake may be ON.

Release the brake.

Make sure that the shaft with the wheel clamped on it can rotate freely.

Repeat the run.

## 8.0 Disposing of the unit

When you decide to get rid of your unit, contact your reseller for a quote or for the regulations on disposal which apply to the unit.

## 8. INSTRUCTIONS FOR DISPOSAL IN EU COUNTRIES

### For waste electrical and electronic equipment

At the time of disposal, at the end of the lifetime of this equipment, you must:

1. NOT dispose of the equipment as municipal waste and separate collection is mandatory.
2. Ask the retailer about collection points authorised for regular disposal.
3. Stick to the standards for correct waste management, to prevent potential effects on the environment and human health.



This symbol indicates that separate collection of waste electrical and electronic equipment is mandatory for scrapping.

## 9.0 Appendices

This chapter contains additional information about the unit.

If reference is made to the exact configuration of the unit, please note that the exact configuration may be different in your country. Consult the order confirmation for details.

## **Appendix: Installation Instructions**

This appendix describes the installation requirements, installation procedures and checks.

**i. Installation requirements.**

**Space requirements.**

The drawings show the minimum safety requirements.

Refer to the drawings for space requirements:

i.1 *Truck Balancer*

Each drawing has two sets of dimensions:

- 1 dotted lines: for measurements regarding the holes for fixing the machine to the floor
- 2 continuous lines: for measurements regarding overall machine surface space

**Floor requirements.**

The floor should be:

- horizontal; within 2° tolerance
- even; within 2 mm
- able to bear the weight of the balancer as stated in Chapter 2 of the Operator's Manual.

The floor on which the balancer will be installed should not relay vibrations from other devices or from outside the building. External vibrations may affect the accuracy of the unit.

**Note:** The balancer must be positioned directly on the floor. Do not use spacers to fill gaps.

If the above conditions are satisfied, the balancer does not need fixing to the floor.

**Power supply requirements.**

Refer to Chapter 2 of the Operator's Manual for mains power requirements.

---

**WARNING: ENSURE THAT AN APPROVED WALL MAINS OUTLET IS AVAILABLE.**

---



---

**WARNING: NEVER GUIDE POWER SUPPLY CABLES OVER THE FLOOR, UNLESS PROTECTED BY AN APPROVED COVER.**

---

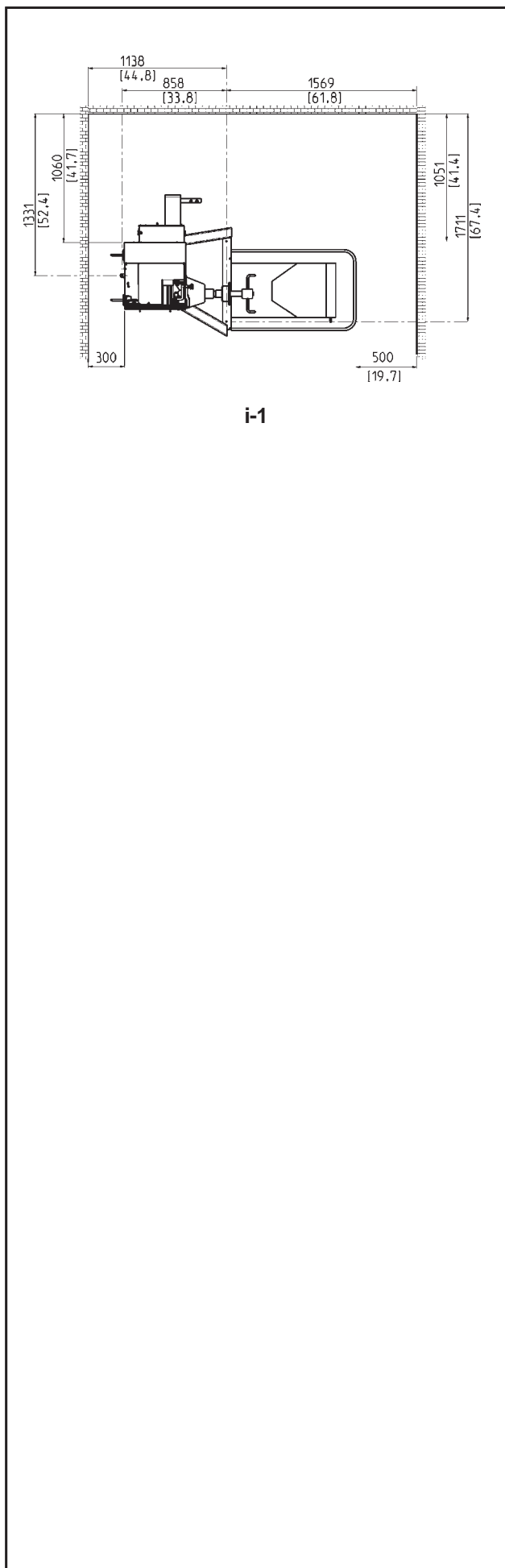

## ii Transportation, unpacking and contents.

### Transportation.

The wheel balancer is supplied on a pallet.

- Use a pallet truck (Figure ii-1) to bring the wheel balancer to its working area.

### Unpacking.

**WARNING: PREVENT THE STRAPS FROM SPRINGING LOOSE AFTER BEING CUT.**

- Cut the straps.
- Open the top of the box.
- Remove staples at the bottom of the box. Lift the box up and over the unit.
- Carefully unwrap the balancer and spare parts supplied.
- Check the contents of the shipment.

### Contents.

The shipment contains:

- a wheel balancer
- an Operator's Manual with Declaration of Conformity (CE)
- the accessories mentioned in Section 3.1 of the Operator's Manual
- 4 storage hooks and flanges.

a mains power cable

a wheel guard assembly

2 bolts and nuts, fitted on the wheel guard shaft.

### Tools required.

- screwdriver / bar (diameter 4.5-5 mm)
- keys: 13, 17 mm

### Positioning.

- Remove the bolts that secure the wheel balancer on the pallet.

**CAUTION: DO NOT LIFT OR MOVE THE WHEEL BALANCER BY THE MAIN SHAFT OR MEASURING UNIT.**

- Refer to Figure ii-2. Move the wheel balancer from the pallet to its working location.

Note: Use the storage hooks (mount as instructed in Chapter iii) and/or the wheel guard shaft (if present) to handle the wheel balancer.

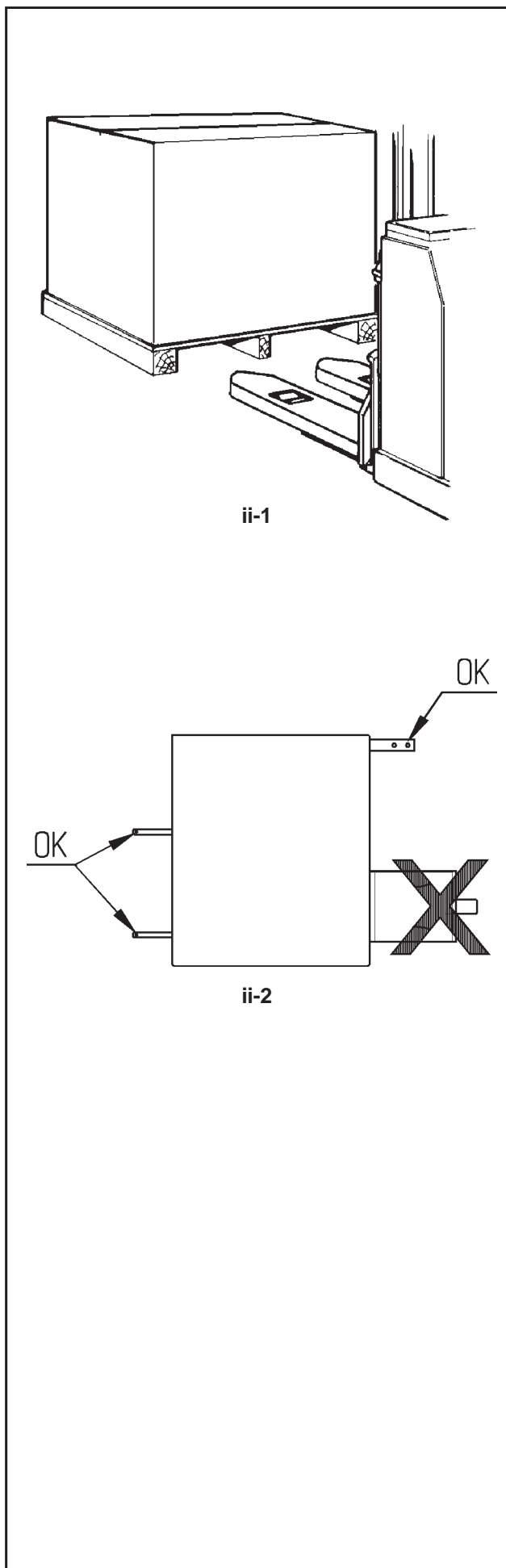

### iii Installation procedures

#### Wheel balancer:

Refer to the drawing in i for correct wheel balancer positioning. If the wheel balancer needs securing, we recommend fixing elements with a diameter of 8 mm, quality 8.8 or higher.

#### Supports for Accessories:

- Unpack the 4 threaded accessory support studs and the support plates.
- Refer to Figure iii-1. Fit the 4 threaded accessory support studs and the plates.

#### Main shaft wheel adaptor:

Before fitting the wheel adaptor, clean the main shaft support cone and the internal adaptor cone carefully.

#### Fig. iii-2 Fitting the wheel adaptor

- 1 main shaft support cone.
  - 2 wheel adaptor basic clamping adaptor.
  - 3 Securing screws (hexagonal socket head CH14).
  - 4 Hexagonal wrench (Allen key) (included).
- Fit the wheel adaptor onto the main shaft support cone so that the cylindrical headed screw at the end of the cone is inserted in one of the slots on the basic clamping adaptor.
  - Fasten the wheel adaptor by tightening the securing screw.

#### Wheel guard:

- Refer to Figure iii-3. Fix the wheel guard on the shaft which sticks out at the back on the right.

#### Clamping devices:

- Put the clamping devices on the accessory studs.

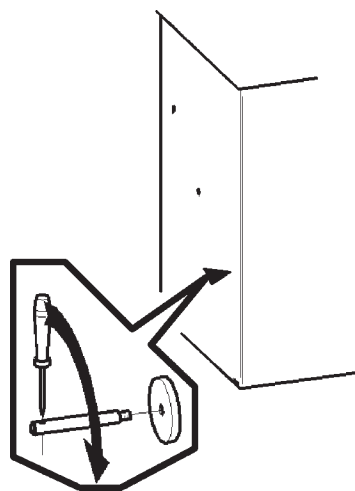

iii-1

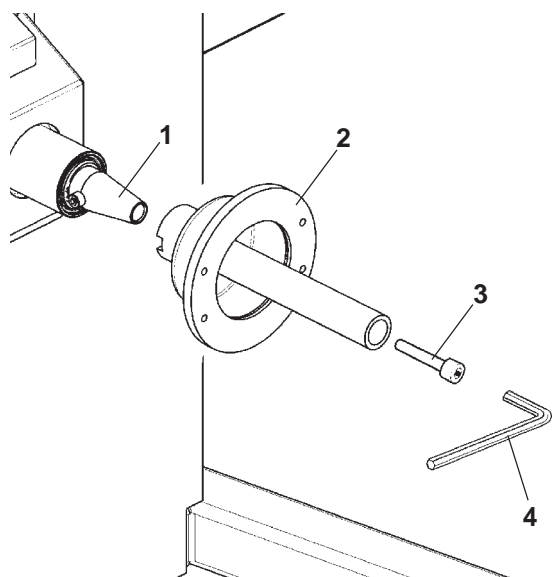

iii-2

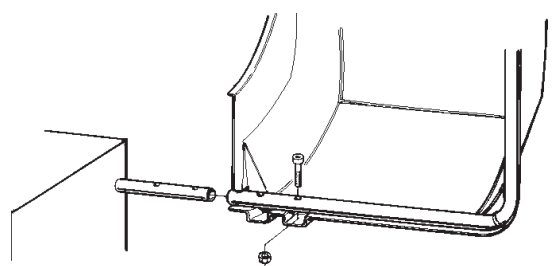

iii-3

### Installing the pneumatic loading device

The loading device for truck wheels is provided separately.

With the loading device wheels weighing up to 250 kg can be pneumatically lifted and positioned exactly on the clamping adaptor.

- The loading device has to be mechanically attached (positive locking) to the machine.

**Fig. iii-4 (1)** Attachment of pneumatic loading device to the machine (seen from the top)

- 1 Pneumatic loading device
- 2 Clip
- 3 Locating stud
- 4 Machine

- Place the loading device over the locating stud from above and insert the clip (A-B).

**Fig. iii-4 (2)** Connection of pneumatic loading device - mounting the foot guard

- 1 Loading device fitted to the machine
- 2 Sliding carriage
- 3 Foot guard, has to be fitted to the loading device
- 4 Air connection (union)
- 5 Holder for foot guard, pre-fitted to loading device
- 6 Clamp for foot guard

- The air supply is provided by means of the pneumatic hose supplied with the machine. The service pressure is 8 bar. An integrated pressure reducer is factory-adjusted to this value and must not be changed by the customer. The line pressure should be at least 100 psi and must never exceed 180 psi.

- Slide the foot guard supplied with the machine into the clamps in the direction shown by the arrow (2, Fig. iii-4), adjust the distance of 1.25 inches as shown and tighten the clamps.

For ease of transport the column side panel is facing inwards (hook for storage of adaptors).

- Unscrew the side panel, turn it round and re-fasten.

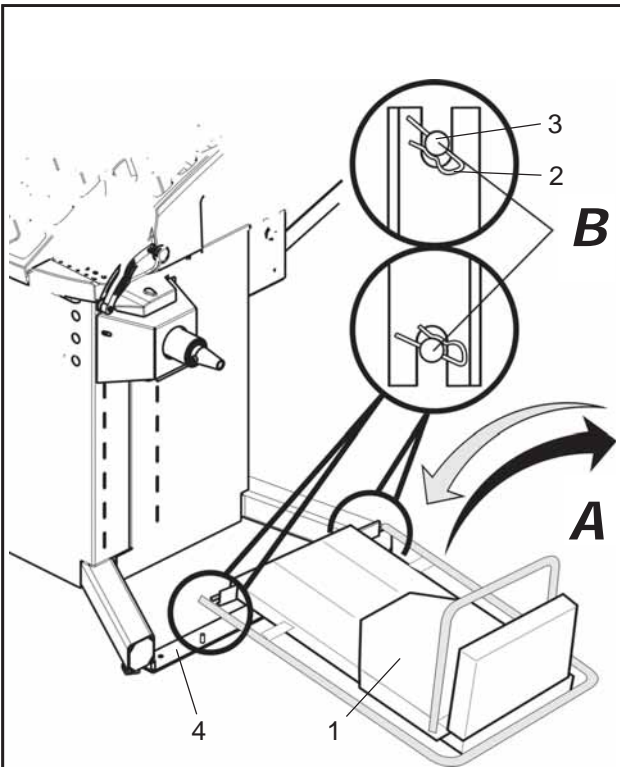

iii-4 (1)

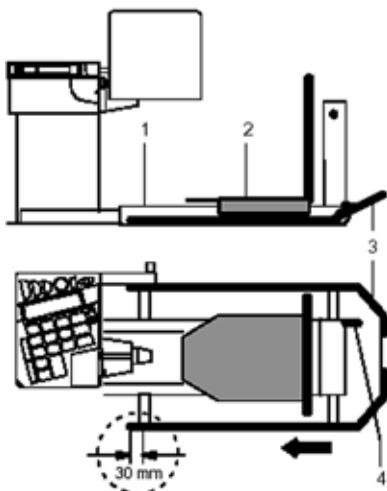

iii-4 (2)



## iv Test procedures

- Balance a wheel to less than 0.25 oz. (5 grams) per plane.
- Perform a User Calibration. See Chapter 6.3.1.

## v Instructing the operator

*(Following applies only if a unit is installed by a service Technician)*

- Show and explain the Safety Booklet.
- Show the operator how to switch the unit on and off.
- Show the operator how to perform an emergency stop.
- Show the operator how to select a wheel type, enter data and apply a weight.

# Product requirements

## *Imbalance weight resolution/suppression*

Truck WB:

Resolution		Normal	Fine	Suppression
Vehicle type				
Truck rim	50, 75, 100, 150 g, 200 ... 900 g in Increments of 100 g 1.00 ... 9.9kg in Increments of 0.1 kg	10 g - 0.50 oz	= 10 * vehicle type 1	
Light truck rim	0.5, 1, 2, 4, 6, ... 98 oz in Increments of 2 oz  10 g - 0.50 oz	1 g - 0.05 oz	= 2 * vehicle type 1	
Car rim	5 g - 0.25 oz	1 g - 0.05 oz	7.1g - 0.25oz (Default values)	

## *Rim dimensions*

Truck WB:

Vehicle type	Distance	Width		Diameter	
		min-max	Step	min-max	Step
Truck [inch]	0 - 400 mm	2.0" - 20.0"	0.25"	8.0" - 14.0"	1"
				14.0" - 30.0"	0.5"
Truck [millimeter]	0 - 400 mm	25mm - 505mm	10mm	190mm - 760mm	10mm
Light Truck [inch]	0 - 400 mm	1.0" - 20.0"	0.5"	8.0" - 14.0"	1"
				14.0" - 20.0"	0.5"
				20.0" - 30.0"	1"
Light Truck [millimeter]	0 - 400 mm	25mm - 505mm	10mm	190mm - 760mm	10mm
Car [inch]	0 - 400 mm	1.0" - 20.0"	0.5"	8.0" - 14.0"	1"
				14.0" - 20.0"	0.5"
				20.0" - 30.0"	1"
Car [millimeter]	0 - 400 mm	25mm - 505mm	10mm	190mm - 760mm	10mm

NOTES:

Equipment Services  
309 Exchange Ave.  
Conway, AR 72032

For Service Support call:  
(USA) 800-225-5786  
(CAN) 800-3624608

For Technical and Service Support email:  
[soecustomerservice@snapon.com](mailto:soecustomerservice@snapon.com)

For Equipment Purchase information email:  
[customerfulfillment@snapon.com](mailto:customerfulfillment@snapon.com)